

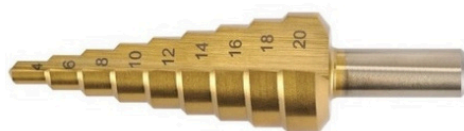

# Catálogo Tarifa 2026



[www.tomisadistribucion.com](http://www.tomisadistribucion.com)

## Índice General Catálogo

- ➔ **Fijaciones** 
- ➔ **Brocas** 
- ➔ **Discos** 
- ➔ **Productos Químicos** 
- ➔ **Bridas y Complementos** 
- ➔ **Puntas y Adaptadores** 
- ➔ **Tornillería** 
- ➔ **Destornilladores** 
- ➔ **Soldadores y Cepillos** 
- ➔ **Coronas y Hojas de Corte** 
- ➔ **Protección** 
- ➔ **Artículos Diversos** 
- ➔ **Alicates y Mordazas** 
- ➔ **Herramientas de Corte** 
- ➔ **Material Eléctrico** 
- ➔ **Herramientas de Mano** 
- ➔ **Llaves de Vaso y Mano** 
- ➔ **Conteras** 

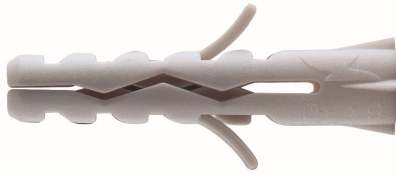
**Tacos de Nylon en Cajas**

<u>Refer:</u>	<u>Medida</u>			<u>Precio €</u> <u>Caja</u>
1011322-TEX	5x25	200	6400	4,99
1011335-TEX	6x30	200	6400	5,39
1011345-TEX	7x30	100	4800	5,63
1011355-TEX	8x40	100	4800	4,55
1011365-TEX	10x50	50	1000	3,32
1011375-TEX	12x60	25	900	2,98
1011381-TEX	14x80	25	250	4,69

**Tacos de Nylon con Cuello en Cajas**

<u>Refer:</u>	<u>Medida</u>			<u>Precio €</u> <u>Caja</u>
1011335/C-TEX	6x30	200	6400	5,39
1011356/C-TEX	8x40	100	4800	4,55
1011366/C-TEX	10x50	50	1000	3,32

**Taco Nylon Universal GX**

<u>Refer:</u>	<u>Medida</u>			<u>Precio €</u> <u>Caja</u>
10150525-TOM	5x25	200	4000	5,74
10150630-TOM	6x30	200	6400	5,74
10150840-TOM	8x40	150	2400	8,49
10151050-TOM	10x50	75	1200	7,80
10151260-TOM	12x60	25	400	4,76
10151470-TOM	14x70	25	400	6,31

<u>Refer:</u>	<u>Medida</u>			<u>Precio €</u> <u>Bolsa</u>
10150525B-TOM	5x25	1000	5000	24,65
10150630B-TOM	6x30	1000	5000	24,36
10150840B-TOM	8x40	500	2500	23,78
10151050B-TOM	10x50	250	1250	22,11
10151260B-TOM	12x60	125	625	17,69

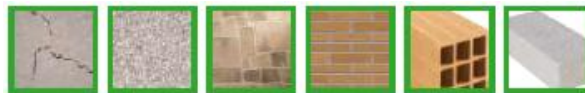

**Conjunto Fijación Tacos + Alcayatas**

<u>Refer:</u>	<u>Medida Taco</u>	<u>Medida Alcayata</u>		<u>Precio €</u> <u>Blister</u>
HSF410	10x50	8x65	250	1.10
HSF412	12x60	10x75	250	2,06

Ideal para la fijación de calentadores y medias cargas.

Compuesto por 2 Tacos GX + 2 Alcayatas (4 piezas).

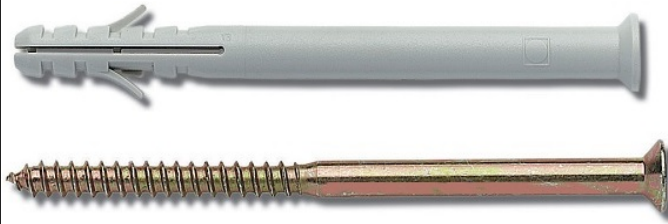

**Tacos de NYLON con tornillo POZY**

<u>Refer:</u>	<u>Medida</u>		<u>Precio €</u>
		<u>Caja</u>	
8722004-ELM	8x60	50	9,16
8722008-ELM	10x100	25	9,80
8722009-ELM	10x115	20	9,18

**Tacos de NYLON con tornillo HEX**

<u>Refer:</u>	<u>Medida</u>		<u>Precio €</u>
		<u>Caja</u>	
8722025-ELM	8x80	50	10,25
8722029-ELM	10x115	20	9,10

**Tacos de nylon con tornillo a GOLPE**



<u>Refer:</u>	<u>Taco</u>	<u>Cabeza</u>		<u>Precio €</u>
			<u>Caja</u>	
8793026-TOM	5x35	Cónica	100	7,00
8793029-TOM	6x40	Cónica	100	8,25
8793030-TOM	6x55	Cónica	100	9,60
8793034-TOM	8x60	Cónica	100	16,38
8793035-TOM	8x75	Cónica	100	20,67
8793036-TOM	8x100	Cónica	50	13,57
8793037-TOM	8x120	Cónica	50	15,62

**Tacos METALICOS con tornillo**



<u>Refer:</u>	<u>Taco</u>		<u>Precio €</u>
		<u>Caja</u>	
60860-VO	10x75	50	19,58
60865-VO	10x90	50	19,11
60870-VO	10x110	50	22,13



**Argolla de Andamio**



<u>Refer:</u>	<u>Medida</u>	<u>∅ Interno</u>		<u>Precio €</u>
			<u>Caja</u>	
TOC1212-GB	12 x 120	23 mm	25	40,17

	Tacos de ACERO para retacar				Precio €
	Refer:	Exterior	Interior		Caja
	8735131-TEX	8 x 30	M-6	100	10,45
	8735141-TEX	10 x 30	M-8	100	15,63
	8735151-TEX	12 x 40	M-10	50	17,81

	Tacos de LATON para expansión				Precio €
	Refer:	Exterior	Interior		Caja
	8725001-FRA	5 x 20	M-4	700	63,64
	8725002-FRA	6.5 x 21	M-5	350	34,86
	8725003/2-FRA	8 x 24	M-6	200	31,62
	8725004/3-TEX	10 x 30	M-8	100	33,51
	8725005-FRA	12 x 35	M-10	100	46,05
	8725008FRA	15 x 40	M-12	50	44,17

	Anclaje Metálico Tornillo			Precio €
	Refer:	Medida		Caja
	70080645	Ø 8 M6 x 45	200	44,02
	70080660	Ø 8 M6 x 60	200	51,07
	70100860	Ø 10 M8 x 60	100	35,00
	70100880	Ø 10 M8 x 80	100	41,19
	70121070	Ø 12 M10 x 70	100	57,48
	701210100	Ø 12 M10 x 100	50	34,72
	70141070	Ø 14 M10 x 70	100	73,61
	701410100	Ø 14 M10 x 100	50	44,74
	70161280	Ø 16 M12 x 80	50	57,10
	701612110	Ø 16 M12 x 110	50	66,98
	702016110	Ø 20 M16 x 110	25	61,60

	Anclaje Metálico Gancho			Precio €
	Refer:	Medida		Caja
	78080645	Ø 8 M6 x 45	100	40,66
	78100860	Ø 10 M8 x 60	100	66,81
	78121070	Ø 12 M10 x 70	50	54,15

	Anclaje Metálico Argolla			Precio €
	Refer:	Medida		Caja
	77080645	Ø 8 M6 x 45	100	40,66
	77100860	Ø 10 M8 x 60	100	69,19
	77121070	Ø 12 M10 x 70	50	54,15



Taco Pladur tipo Aletas			Precio €
Refer:	Medida		Caja
8711912-TOM	10x33	100	7,25



Taco Roscado Plástico			Precio €
Refer:	Medida		Caja
8742309-TOM	11x30	100	6,52



Taco Metálico Pladur cincado				Precio €
Refer:	Taco	Tornillo		Caja
48011-GB	8x40	M4x46	200	41,04
48063-GB	10x50	M5x65	100	32,56



Alicate para Tacos Metálicos Pladur		Precio €
Refer:		
TK30-GB	 	17,64



Cierre con Doble Tornillo

<b>Abrazaderas Metálicas Ligeras M-6</b>				<b>Precio €</b>
<u>Refer:</u>	<u>Acabado</u>	<u>Ø</u>		<u>Caja</u>
125/0612-DE	Bicromatado	12 mm	100	18,63
125/0614-DE	"	14 mm	100	19,20
125/0615-DE	"	15 mm	100	19,38
125/0618-DE	"	18 mm	100	20,70
125/0620-DE	"	20 mm	100	20,91
125/0622-DE	"	22 mm	100	21,48
125/0625-DE	"	25 mm	100	22,59
125/0628-DE	"	28 mm	100	23,94
125/0632-DE	"	32 mm	50	13,33
125/0640-DE	"	40 mm	50	16,78
125/0650-DE	"	50 mm	50	21,04
125/0663-DE	"	63 mm	50	25,35
125/0610Z-DE	Cincado	10 mm	100	17,96
125/0612N-DE	Niquelado	12 mm	100	24,61



<b>Tornillo para abrazaderas Metálicas</b>				<b>Precio €</b>
<u>Refer:</u>	<u>Medida</u>		<u>Caja</u>	
650630/B-DE	M-6x30x5	100		4,37
650640/B-DE	M-6x40x5	100		5,84
650650/B-DE	M-6x50x5	100		6,92
650840/B-NOR	M-8x40x9	100		8,70



<b>Abrazaderas Isofónicas M-6</b>				<b>Precio €</b>
<u>Refer:</u>	<u>Ø</u>		<u>Caja</u>	
126/0615B-DE	15 mm	100		28,17
126/0618B-DE	18 mm	100		29,51
126/0622B-DE	22 mm	100		32,02
126/0625B-DE	26 mm	100		36,22
126/0632B-DE	32 mm	50		20,79



<b>Abrazaderas Metálicas de Dos Patas</b>				<b>Precio €</b>
<u>Refer:</u>	<u>Ø</u>		<u>Caja</u>	
128/08Z-DE	8 mm	100		9,10
128/10Z-DE	10 mm	100		9,69
128/12Z-DE	12 mm	100		10,15
128/15Z-DE	15 mm	100		11,34
128/18Z-DE	18 mm	100		15,36
128/20Z-DE	20 mm	100		16,55
128/22Z-DE	22 mm	100		17,29
128/25Z-DE	25 mm	100		18,13
128/28Z-DE	28 mm	100		19,53
128/32Z-DE	32 mm	100		23,24
128/40Z-DE	40 mm	50		13,12
128/50Z-DE	50 mm	50		19,30



<b>Abrazaderas Metálicas Una Pata</b>				<b>Precio €</b>
<u>Refer:</u>	<u>Ø</u>		<u>Caja</u>	
127/08Z-DE	8 mm	100		5,05
127/10Z-DE	10 mm	100		6,04
127/12Z-DE	12 mm	100		7,09
127/15Z-DE	15 mm	100		7,89
127/18Z-DE	18 mm	100		11,22
127/20Z-DE	20 mm	100		11,65
127/22Z-DE	22 mm	100		12,44
127/25Z-DE	25 mm	100		13,86
127/28Z-DE	28 mm	100		15,94
127/32Z-DE	32 mm	50		9,59
127/40Z-DE	40 mm	50		12,77
127/50Z-DE	50 mm	50		18,63

	<b>Tornillos para WC y Bidet Laterales</b>			<b>Precio €</b>
	<u>Refer:</u>	<u>Taco</u>	<u>Tornillo</u>	<u>Bolsa</u>
871422	8x40	5x70 Zinc	100	1,73
	<b>Tornillos para Lavabo</b>			<b>Precio €</b>
	<u>Refer:</u>	<u>Taco</u>	<u>Tornillo</u>	<u>Bolsa</u>
8714302	12x60	10x110 Zincado	100	1,61
	<b>Tornillos para WC y Bidet</b>			<b>Precio €</b>
	<u>Refer:</u>	<u>Taco</u>	<u>Tornillo</u>	<u>Bolsa</u>
871421	8x40	6x75 Inox	100	1,83
	<b>Tornillos para WC Taza-Tanque</b>			<b>Precio €</b>
	<u>Refer:</u>	<u>Tornillo</u>	<u>Bolsa</u>	
871424	6x90 Inox	100	2,12	
	<b>Tornillos para WC y Bidet con Escuadra</b>			<b>Precio €</b>
	<u>Refer:</u>	<u>Taco</u>	<u>Tornillo</u>	<u>Bolsa</u>
871423	8x40	5x60 Zincado	50	4,20

	<b>Arandelas de Ala Ancha Zincadas</b>			<b>Precio €</b>
	<u>Refer:</u>	<u>Ø</u>	<u>Caja</u>	<u>Caja</u>
<p>DIN 9021</p>	709021/04-TOM	M-4	1000	7,32
	709021/05-TOM	M-5	1000	15,29
	709021/06-TOM	M-6	1000	24,42
	709021/08-TOM	M-8	500	30,74
	709021/10-TOM	M-10	250	25,70
	709021/12D-TOM	M-12	200	37,45
	709021/14D-TOM	M-14	200	42,27
	709021/16-TOM	M-16	100	32,76
	709021/18-TOM	M-18	50	25,20
	709021/20-TOM	M-20	50	38,14

	<b>Cinta Perforada Galvanizada</b>			
	<u>Refer:</u>	<u>Medida</u>	<u>Caja</u>	<u>Precio €</u>
124/1708-NOR	10mts x 17mm x 0,8mm	6,24		

	<b>Manguitos Unión Hexagonales</b>		
	<u>Refer:</u>	<u>Medida</u>	<u>Caja</u>
8736920-TEX	M-5 x 15	100	10,04
8736921-TEX	M-6 x 20	100	10,96
8736931-TEX	M-8 x 25	50	8,95
8736941-TEX	M-10 x 30	50	18,88
8736951-TEX	M-12 x 35	50	26,61



**Taco IZO para Paneles Aislantes**

Refer:	Medida		Precio € Caja
8753521-TEX	10 x 70	200	24,18
8753522-TEX	10 x 90	200	29,75

Indicado para fijación de paneles aislantes blandos o rígidos resistentes a la compresión. Lana de vidrio, poliestirol, corcho...



**Cánula para cartuchos Silicona**

Refer:		Precio € Caja
34280-TOM	24	5,53



**Cánula para Espuma Poliuretano**

Refer:		Precio € Caja
10C21012-TOM	10	6,90



**Cánula Mezcladora Taco Químico**

Refer:	Medida		Precio € Bolsa
10CM12-TOM	M-17	12	4,16



**Cánula para Mortero y Lecheo**

Refer:		Precio € Caja
73411-TOM	10	2,60



**Tamices de Nylon para Taco Químico**

Refer:	Varilla	Medida		Precio € Bolsa
10CB08-TOM	M-6/8	12 x 60	10	1,88
10CB01-TOM	M-8/10	15 x 85	10	1,82
10CB02-TOM	M-8/10	16 x 130	10	2,28
10CB011-TOM	M-8/10	16 x 330 Fotovoltaica	5	3,47
10CB03-TOM	M-12	20 x 85	10	2,40

Imprescindible para anclajes en presencia de ladrillos huecos.



**Taco de Nylon para Argolla de Andamio**

Refer:	Medida		Precio € Caja
101114100-TEX	14 x 100	40	8,75

**Tacos de Vuelco de MUELLE**

<u>Refer:</u>	<u>Descripción</u>	<u>Medida</u>		<u>Precio €</u> <u>Caja</u>
1004020-TOM	Espárrago con arandela y tornillo	M-4 x 75	50	24,12
1004022-TOM	Espárrago con arandela y tornillo	M-5 x 95	50	27,04
1004028-TOM	Espárrago con arandela y tornillo	M-8 x 100	50	41,27
1004024-TOM	Gancho abierto con arandela y tornillo	M-4 x 75	50	25,68
1004025-TOM	Gancho abierto con arandela y tornillo	M-5 x 95	50	29,52
873002-IFT	Gancho cerrado con arandela y tornillo	M-5 x 100	50	21,82

**Tacos de Vuelco BASCULANTE**

<u>Refer:</u>	<u>Descripción</u>	<u>Medida</u>		<u>Precio €</u> <u>Caja</u>
874001-IFT	Gancho cerrado con arandela y tornillo	M-6 x 130	40	22,31
1004027-TOM	Espárrago con arandela y tornillo	M-6 x 100	50	32,48
1004029-TOM	Gancho abierto con arandela y tornillo	M-6 x 85	50	34,02

**Accesorio Vuelco para varilla**

<u>Refer:</u>	<u>Descripción</u>	<u>Ø</u>		<u>Caja</u>
875001-IFT	Basculante M-5	16 mm	100	23,88
1004026-TOM	Muelle M-8	22 mm	50	26,18

**Abrazaderas Sin Fin Metálicas**

Acero Cincado

Flejes de 9 mm

Tornillo de cabeza hexagonal con ranura

<u>Refer:</u>	<u>Rango de Apertura</u>		<u>Precio €</u> <u>Caja</u>
124/0812-WH	De 8 a 12 mm	100	32,56
124/0816-WH	De 10 a 16 mm	100	34,20
124/1220-WH	De 12 a 22 mm	100	36,91
124/1625-WH	De 16 a 27 mm	100	37,78
124/2032-WH	De 20 a 32 mm	100	40,70
124/2540-WH	De 25 a 40 mm	50	21,54
124/3250-WH	De 32 a 50 mm	50	23,26
124/4060-WH	De 40 a 60 mm	50	26,81
124/5070-WH	De 50 a 70 mm	25	14,60
124/6080-WH	De 60 a 80 mm	25	15,53
124/7090-WH	De 70 a 90 mm	25	15,85
124/80100-WH	De 80 a 100 mm	25	16,26
124/90110-WH	De 90 a 110 mm	25	16,56
124/100120-WH	De 100 a 120 mm	25	17,06
124/110130-WH	De 110 a 130 mm	25	18,26
124/120140-WH	De 120 a 140 mm	25	19,14



Para instalación de tubos de agua, electricidad, gas y calefacción

Elevada resistencia térmica (de -40° a +80°)

Fabricado en Poliamida 6 Nylon Gris

Para guías de: 20x10 - 25x7,5 - 27x18

**Abrazaderas de Nylon LPH para tubos**

<u>Refer:</u>	<u>∅</u>		<u>Precio €</u> <u>Caja</u>
25531-TOM	15 - 18 mm	100	22,56
25532-TOM	20 - 25 mm	50	15,87
25533-TOM	25 - 32 mm	50	17,86



Abrazaderas de PVC ideadas para la

fijación de tubos plásticos de 16 a 40 mm

Fabricado en PVC autoextinguible

**Abrazaderas de Nylon E-CLIP para tubos**

<u>Refer:</u>	<u>∅</u>		<u>Precio €</u> <u>Caja</u>
8713502116-ELM	16 mm	100	10,05
8713502120-TOM	20 mm	100	12,12
8713502125-TOM	25 mm	100	12,72
8713502132-TOM	32 mm	50	8,97
8713502140-ELM	40 mm	50	15,75

**Abrazadera Metálica Gas Butano**

<u>Refer:</u>	<u>∅</u>		<u>Precio €</u> <u>Caja</u>
123/1618-WH	16-18 mm	100	32,75

Especial para el cierre de gomas de butano al regulador de gas.

## Broca Sds Plus 4 Puntas de Corte Ref: 489/...



5 x 110	3,92
5 x 160	4,72
6 x 110	4,32
6 x 160	5,12
8 x 110	5,48
8 x 160	6,34
8 x 310	8,92
8 x 450	11,92
10 x 110	6,77
10 x 160	7,63
10 x 310	9,77
10 x 450	14,06
12 x 160	9,34
12 x 210	10,63
12 x 310	13,20
12 x 450	17,50
<b>N</b> 14 x 210	12,91
<b>N</b> 14 x 310	16,26
<b>N</b> 14 x 450	22,96
<b>N</b> 16 x 210	14,53
<b>N</b> 16 x 310	19,56
<b>N</b> 16 x 450	25,84
<b>N</b> 18 x 310	24,30
<b>N</b> 18 x 450	29,20
<b>N</b> 20 x 310	27,80
<b>N</b> 20 x 450	35,62



### Principales características de la Broca Sds Plus 4 Puntas

- Elevado volumen de la flauta geométrica que asegura la extracción de polvo.
- Para uso con martillos rotativos y percutores con sistema de enganche rápido.
- Punta de centrado para facilitar el taladrado.
- Especialmente indicada para perforar materiales como ladrillo, hormigón y mampostería.

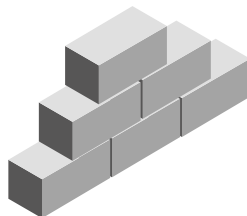
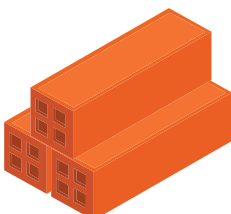



**Brocas HSS Laminadas para Metal**

<u>Refer:</u>	<u>Medida</u>	<u>Precio €</u>
471/01-FX	1 x 34	0,31
471/015-FX	1.5 x 40	0,32
471/02-FX	2 x 49	0,34
471/025-FX	2.5 x 57	0,36
471/03-FX	3 x 61	0,39
471/0325-FX	3.25 x 65	0,40
471/035-FX	3.5 x 70	0,44
471/0375-FX	3.75 x 70	0,45
471/04-FX	4 x 75	0,45
471/045-FX	4.5 x 80	0,56
471/05-FX	5 x 86	0,56
471/0525-FX	5.25 x 86	0,63
471/055-FX	5.5 x 93	0,59
471/0575-FX	5.75 x 93	0,66
471/06-FX	6 x 93	0,66
471/065-FX	6.5 x 101	0,70
471/07L-FX	7 x 150 larga	2,13
471/07-FX	7 x 109	0,81
471/075-FX	7.5 x 109	0,99

<u>Refer:</u>	<u>Medida</u>	<u>Precio €</u>
471/08-FX	8 x 117	1,40
471/085-FX	8.5 x 117	1,40
471/09-FX	9 x 125	1,42
471/095-FX	9.5 x 125	1,67
471/10-FX	10 x 133	1,87
471/11-FX	11 x 142	2,45
471/115-FX	11.5 x 142	2,91
471/12-FX	12 x 151	2,91
471/13-FX	13 x 151	3,57
471/14-FX	14 x 151	5,28

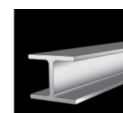
En estuche con 10 / 5 unidades

**Brocas HSS Rectificadas para Metal**

<u>Refer:</u>	<u>Medida</u>	<u>Precio €</u>
472/01-FX	1 x 34	0,42
472/015-FX	1.5 x 40	0,49
472/02-FX	2 x 49	0,47
472/025-FX	2.5 x 57	0,49
472/03-FX	3 x 61	0,56
472/035-FX	3.5 x 70	0,63
472/04-FX	4 x 75	0,70
472/0425-FX	4.25 x 75	0,78
472/045-FX	4.5 x 80	0,78
472/05-FX	5 x 86	0,96
472/0525-FX	5.25 x 86	1,05
472/055-FX	5.5 x 93	1,07
472/06-FX	6 x 93	1,08
472/065-FX	6.5 x 101	1,26
472/07-FX	7 x 109	1,77
472/075-FX	7.5 x 109	2,01
472/08-FX	8 x 117	2,18
472/085-FX	8.5 x 117	2,37
472/09-FX	9 x 125	2,86

<u>Refer:</u>	<u>Medida</u>	<u>Precio €</u>
472/095-FX	9.5 x 125	3,13
472/10-FX	10 x 133	3,47
472/11-FX	11 x 142	4,47
472/12-FX	12 x 151	5,45
472/13-FX	13 x 151	7,10
472/14-FX	14 x 151	9,10
472/15-FX	15 x 170	9,53
472/16-FX	16 x 178	13,46
472/17-FX	17 x 185	13,95
472/18-FX	18 x 191	14,94
472/19-FX	19 x 191	15,20
472/20-FX	20 x 205	15,44

En estuche con 10 / 5 unidades

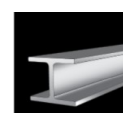

**Brocas HSS Rectificadas para Metal Serie Larga**

<u>Refer:</u>	<u>Medida</u>	<u>Precio €</u>
472/03L-FX	3 x 100	1,09
472/04L-FX	4 x 120	1,24
472/05L-FX	5 x 132	1,70
472/06L-FX	6 x 139	2,15
472/08L-FX	8 x 165	3,07
472/10L-FX	10 x 184	4,30

*En estuche con 10 / 5 unidades*

**Brocas HSS Cobalto 5 % para Metal**

<u>Refer:</u>	<u>Medida</u>	<u>Precio €</u>
474/01-FX	1 x 34	0,36
474/015-FX	1.5 x 40	0,42
474/02-FX	2 x 49	0,45
474/025-FX	2.5 x 57	0,57
474/03-FX	3 x 61	0,66
474/0325-FX	3.25 x 65	0,86
474/035-FX	3.5 x 70	0,86
474/0375-FX	3.75 x 75	0,93
474/04-FX	4 x 75	1,08
474/0425-FX	4.25 x 75	1,37
474/045-FX	4.5 x 80	1,37
474/0475-FX	4.75 x 85	1,40
474/05-FX	5 x 85	1,43
474/0525-FX	5.25 x 85	1,46
474/055-FX	5.5 x 93	1,50
474/06-FX	6 x 93	1,70
474/065-FX	6.5 x 101	2,18
474/07-FX	7 x 109	2,47
474/075-FX	7.5 x 109	2,86

<u>Refer:</u>	<u>Medida</u>	<u>Precio €</u>
474/08-FX	8 x 117	3,10
474/085-FX	8.5 x 117	3,78
474/09-FX	9 x 125	4,34
474/095-FX	9.5 x 125	4,73
474/10-FX	10 x 130	5,69
474/105-FX	10.5 x 130	6,16
474/11-FX	11 x 140	7,20
474/115-FX	11.5 x 140	9,05
474/12-FX	12 x 151	9,43
474/13-FX	13 x 151	10,12
474/14-FX	14 x 155	11,65

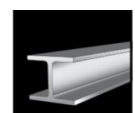
*En estuche con 10 / 5 unidades*

**Brocas Escalonadas HSS TiN para Metal**

<u>Refer:</u>	<u>Medida</u>	<u>Precio €</u>
443/2-TOM	4-20 mm	16,13
443/3-TOM	4-32 mm	27,85
443/4-TOM	6-40 mm	44,64





**Brocas Widia "SUPER" Profesional**
**Largo Estandar**

<b>Refer:</b>	<b>Medida</b>	<b>Precio €</b>
478/03-FX	3 x 60	0,70
478/04-FX	4 x 75	0,77
478/05-FX	5 x 85	0,85
478/06-FX	6 x 100	0,97
478/07-FX	7 x 100	1,21
478/08-FX	8 x 120	1,66
478/10-FX	10 x 120	2,33
478/12-FX	12 x 150	3,20
478/13-FX	13 x 150	4,15
478/14-FX	14 x 150	4,50
478/15-FX	15 x 150	6,04
478/16-FX	16 x 150	6,45
478/18-FX	18 x 150	7,15
478/19-FX	19 x 160	8,30
478/20-FX	20 x 160	8,95

**Serie Larga**

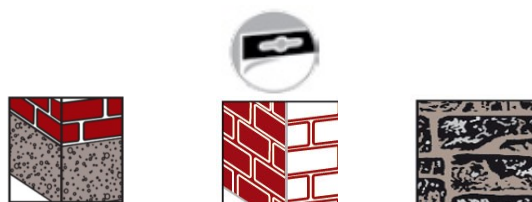
<b>Refer:</b>	<b>Medida</b>	<b>Precio €</b>
478/05L-FX	5 x 150	1,55
478/06L-FX	6 x 200	1,61
478/07L-FX	7 x 200	2,25
478/08L-FX	8 x 200	2,33
478/09L-FX	9 x 200	2,84
478/10L-FX	10 x 200	2,90
478/12L-FX	12 x 200	4,03

*En funda de plástico individual*

**Brocas Widia Pasamuros Profesional**

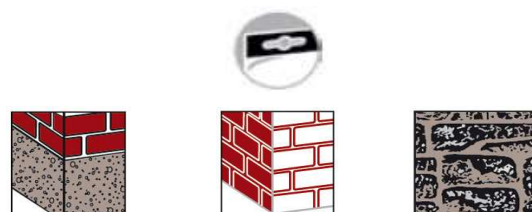
<b>Refer:</b>	<b>Medida</b>	<b>Precio €</b>
482/06-FX	6 x 400	3,57
482/08-FX	8 x 400	3,90
482/10-FX	10 x 400	5,65
482/12-FX	12 x 400	8,76
482/14-FX	14 x 400	10,75
482/16-FX	16 x 400	13,72
482/18-FX	18 x 400	17,16
482/20-FX	20 x 400	18,74

*En funda de plástico individual*

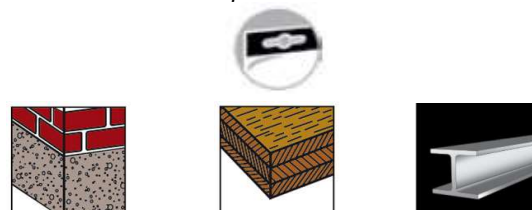
**Brocas Multimaterial Profesional**

<b>Refer:</b>	<b>Medida</b>	<b>Precio €</b>
486/04-FX	4 x 85	3,24
486/05-FX	5 x 90	3,40
486/06-FX	6 x 95	3,74
486/08-FX	8 x 120	4,58
486/10-FX	10 x 150	4,92

*En funda de plástico individual*

Para uso en diferentes materiales de construcción

**Brocas Widia "SDS Plus" para Hormigón**

<u>Refer:</u>	<u>Medida</u>	<u>Precio €</u>
479/04110-FX	4 x 110	2,70
479/05110-FX	5 x 110	2,70
479/06110-FX	6 x 110	3,02
479/08110-FX	8 x 110	4,60
479/10110-FX	10 x 110	4,80
479/05160-FX	5 x 160	3,02
479/06160-FX	6 x 160	3,02
479/07160-FX	7 x 160	4,75
479/08160-FX	8 x 160	4,75
479/09160-FX	9 x 160	4,80
479/10160-FX	10 x 160	4,80
479/12160-FX	12 x 160	4,95
479/06210-FX	6 x 210	3,90
479/08210-FX	8 x 210	4,80
479/10210-FX	10 x 210	5,30
479/12210-FX	12 x 210	5,45
479/13210-FX	13 x 210	5,90
479/14210-FX	14 x 210	6,50
479/16210-FX	16 x 210	6,90
479/18210-FX	18 x 210	8,13

<u>Refer:</u>	<u>Medida</u>	<u>Precio €</u>
479/08310-FX	8 x 310	5,40
479/10310-FX	10 x 310	5,60
479/12310-FX	12 x 310	6,15
479/14310-FX	14 x 310	7,76

*En funda de plástico individual*

479/08450-FX	8 x 450	6,18
479/10450-FX	10 x 450	6,25
479/12450-FX	12 x 450	6,90
479/14450-FX	14 x 450	9,13
479/16450-FX	16 x 450	11,98
479/18450-FX	18 x 450	14,68
479/20450-FX	20 x 450	18,35

**Brocas especiales para Cristal y Azulejos**

<u>Refer:</u>	<u>Medida</u>	<u>Precio €</u>
485/04-FX	4 x 60	3,62
485/05-FX	5 x 70	3,73
485/06-FX	6 x 75	4,82
485/08-FX	8 x 80	5,94
485/10-FX	10 x 85	7,45

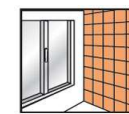

*En funda de plástico individual*

- Azulejos
- Botellas
- Cristales
- Cerámicas
- Tejas
- Metacrilato

- Trabajar a bajas revoluciones
- Trabajar con refrigeración
- Utilizar sólo con rotación

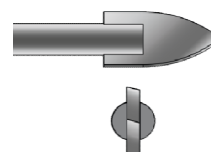

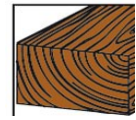

**Brocas de Tres Puntas para Madera**

Refer:	Medida	Precio €
480/03-FX	3 x 60	0,55
480/04-FX	4 x 75	0,59
480/05-FX	5 x 85	0,81
480/06-FX	6 x 95	1,03
480/07-FX	7 x 100	1,39
480/08-FX	8 x 115	1,66
480/09-FX	9 x 115	1,98
480/10-FX	10 x 135	2,43
480/12-FX	12 x 155	3,60

Refer:	Medida	Precio €
480/13-FX	13 x 170	3,95
480/22-FX	22 x 210	12,25
480/24-FX	24 x 215	15,00

En funda de plástico individual



**Brocas de Tres Puntas para Madera Serie Larga**

Refer:	Medida	Precio €
465/06300-PR	6 x 300	3,52
465/08450-PR	8 x 400	5,68
465/10450-PR	10 x 400	6,98

En funda de plástico individual

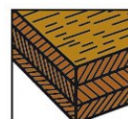

**Brocas de Tres Puntas para Madera Inserción Hexagonal 1/4"**

Refer:	Medida	Precio €
480H/03-FX	3 x 82	1,11
480H/06-FX	4 x 96	1,15
480H/05-FX	5 x 106	1,32
480H/06-FX	6 x 113	1,44
480H/08-FX	8 x 117	1,78

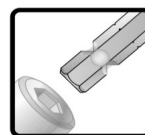

En funda de plástico individual





**Brocas de Pala para Madera**

En funda de plástico individual

Refer:	Medida	Precio €
481/08-FX	8 x 155	1,56
481/10-FX	10 x 155	1,63
481/12-FX	12 x 155	1,72
481/14-FX	14 x 155	1,79
481/16-FX	16 x 155	1,84
481/18-FX	18 x 155	1,91
481/20-FX	20 x 155	1,98
481/22-FX	22 x 155	2,15

Refer:	Medida	Precio €
481/24-FX	24 x 165	2,20
481/25-FX	25 x 165	2,34
481/28-FX	28 x 165	2,51
481/30-FX	30 x 165	2,98
481/32-FX	32 x 165	3,35
481/35-FX	35 x 165	3,44
481/38-FX	38 x 165	3,56
481/40-FX	40 x 165	3,88

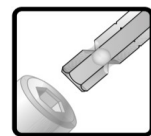

**Alargadera para Brocas de Pala de 150 mm**

Refer: 3057H245

Incluye llave Allen para apriete

Precio € 5,70



**Brocas HSS Rectificadas para Metal Inserción Hexagonal 1/4"**

Refer:	Medida	Precio €
484/02H-FX	2 x 70	0,55
484/025H-FX	2,5 x 75	0,61
484/03H-FX	3 x 77	0,85
484/035H-FX	3,5 x 85	0,91
484/04H-FX	4 x 88	1,02
484/045H-FX	4,5 x 95	1,21
484/05H-FX	5 x 105	1,45
484/06H-FX	6 x 105	2,20

En bolsa de plástico con 10 uds.

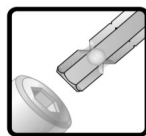

**Brocas Widia "SUPER" Profesional Inserción Hexagonal 1/4"**

Refer:	Medida	Precio €
478H/05-FX	5 x 85	1,64
478H/06-FX	6 x 100	1,86
478H/08-FX	8 x 117	2,19
478H/10-FX	10 x 117	2,64



En funda de plástico individual

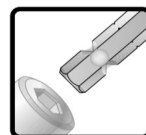



**Juego Brocas HSS Cobalto, 19 pzs**

Refer:	Medidas	Precio €
45214-TOM	1,0 - 10 mm x 0,5	48,02



**Juegos Brocas HSS Cobalto, 13 pzs**

Refer:	Medidas	Precio €
45213-TOM	1,5 - 6,5 mm x 0,5	20,24



**Juego Brocas Mixtas, 9 pzs**

Refer:	Medidas	Precio €
458-PR	5, 6, 8 mm Metal - Pared - Madera	5,45



**Juego Brocas HSS Laminadas, 13 pzs**

Refer:	Medidas	Precio €
450-TOM	1.5, 2, 2.5, 3, 3.2, 3.5, 4, 4.5, 4.8, 5, 5.5, 6, 6.5 mm	5,28

**Maletín Vacío para Brocas Hss**

Refer:	Medidas	Precio €
474BOX-FX	1 mm a 10 mm x 0,5 mm	19,54

**Juego Brocas de Widia, 5 pzs**

Refer:	Medidas	Precio €
466/5-TOM	4, 5, 6, 8, 10 mm	4,34

**Juego Brocas HSS 1/4" Hexagonal, 5 pzs**

Refer:	Medidas	Precio €
3057H750-TOP	4, 5, 6, 8, 10 mm	14,62

**Juego Brocas para Madera, 8 pzs**

Refer:	Medidas	Precio €
463/8-PR	3, 4, 5, 6, 7, 8, 9, 10 mm	6,75

**Juego Brocas Hss Sds Plus, 7 pzs**

Refer:	Medidas	Precio €
479-TOM	3, 3.5, 4, 4.5 5, 6, 8 mm	22,56

**Juego Brocas Hormigón Sds Plus, 7 pzs**

Refer:	Medidas	Precio €
101035-TOM	5, 6, 8 x 110 mm 6, 8, 10, 12 x 160 mm	20,45

**Juego Brocas Hss, 19 pzs**

Refer:	Medidas	Precio €
101010-TOM	1,0 - 10 mm x 0,5	12,64

**Juego Brocas Escalonadas Hss Tin, 3 pzs**

Refer:	Medidas	Precio €
101116-TOM	4-12, 4-20, 4-32 mm	31,75

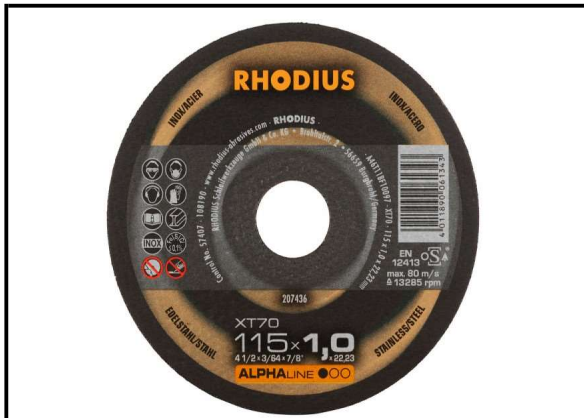

**Disco de Corte para INOX**

<b>Refer:</b>			<b>Precio €</b>
29207436-ROD	115 x 1,0 x 22,23	100	1,26

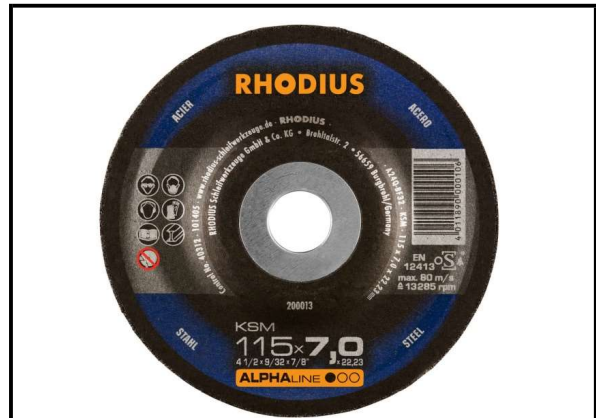

**Disco Desbaste para Acero**

<b>Refer:</b>			<b>Precio €</b>
29200013-ROD	115 x 7,0 x 22,23	25	3,52

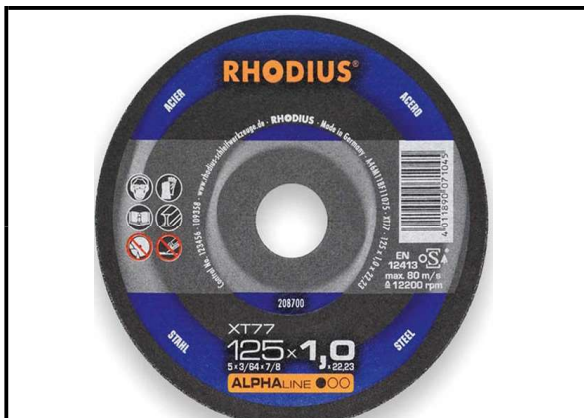

**Disco de Corte para Acero**

<b>Refer:</b>			<b>Precio €</b>
29208698-ROD	115 x 1,0 x 22,23	100	1,37
29208700-ROD	125 x 1,0 x 22,23	100	1,51
29200631-ROD	115 x 3,0 x 22,23	25	1,82

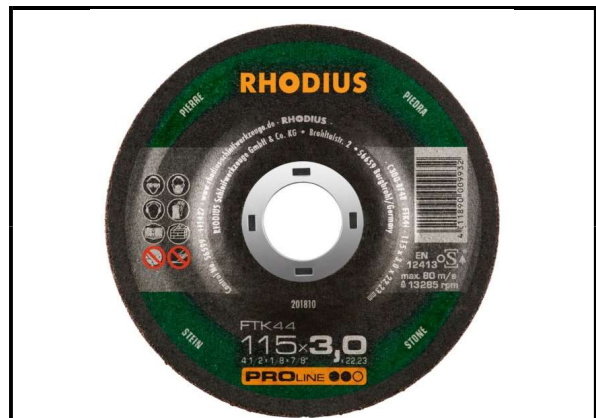

**Disco de Corte para Piedra**

<b>Refer:</b>			<b>Precio €</b>
29204625-ROD	115 x 1,5 x 22,23	50	3,10
29201810-ROD	115 x 3,0 x 22,23	25	2,32



**Disco Desbaste para Piedra**

<b>Refer:</b>	<b>Grano</b>			<b>Precio €</b>
76DSFC11536-TOM	36	115	10	3,41
76DSFC11560-TOM	60	115	10	3,41
76DSFC11580-TOM	80	115	10	3,41
76DSFC18060-TOM	60	180	10	4,73

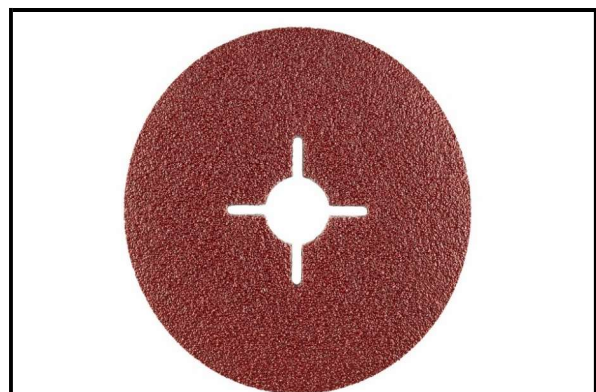

**Disco Abrasivo para Metal**

<b>Refer:</b>	<b>Grano</b>			<b>Precio €</b>
29300001-ROD	16	115	25	1,03
29300002-ROD	24	115	25	0,91
29300003-ROD	36	115	25	0,88
29300006-ROD	60	115	25	0,82
29300008-ROD	100	115	25	0,76



**Disco Diamante para "Madera"**

Refer:			Precio €
29CDM115-GM	115 x 22,23	10	8,43
29CDM230-GM	230 x 22,23	5	22,46

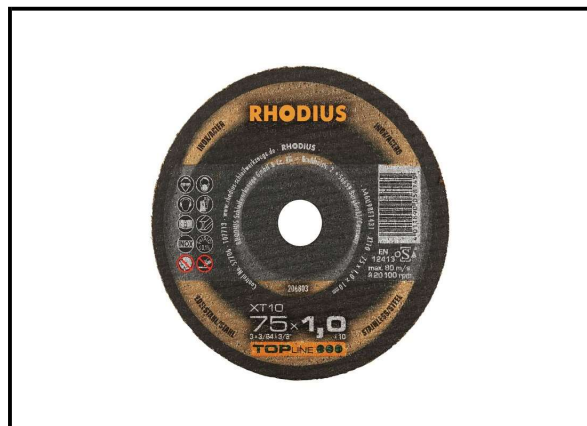

**Disco de Corte Acero Mini**

Refer:			Precio €
29206803-ROD	75 x 1,0 x 10	50	2,97



**Disco Diamante Porcelánico**

Refer:			Precio €
29303101-ROD	115 x 1,2 x 5 x 22,23	1	32,49
29303104-ROD	230 x 1,2 x 5 x 22,23	1	76,55



**Disco Diamante Segmentado**

Refer:			Precio €
29303185-ROD	115 x 2,0 x 7 x 22,23	1	16,25
29303189-ROD	230 x 2,4 x 7 x 22,23	1	45,54

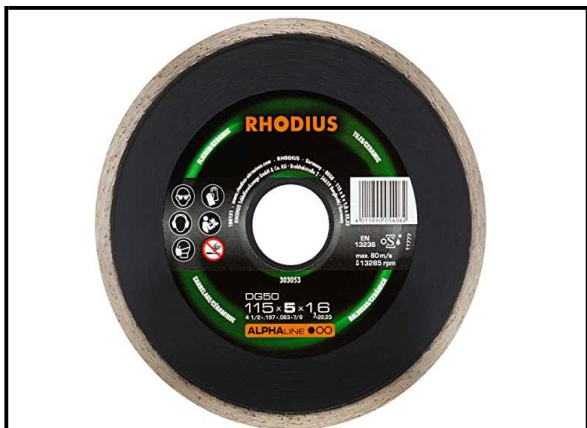

**Disco Diamante Liso**

Refer:			Precio €
29303053-ROD	115 x 1,6 x 5,0 x 22,23	1	12,34



**Disco Diamante Continuo**

Refer:			Precio €
29303402-ROD	115 x 1,9 x 7 x 22,23	1	16,41

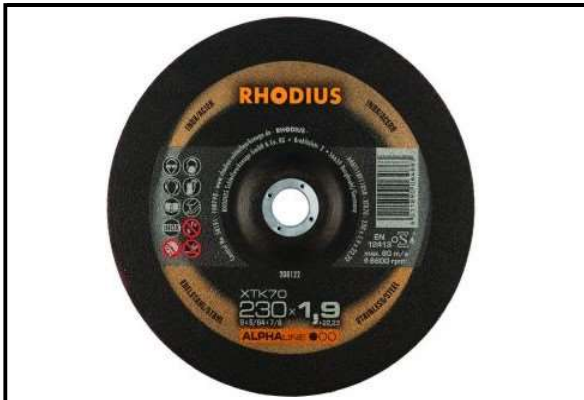

**Disco de Corte para INOX**

<b>Refer:</b>			<b>Precio €</b>
29208122-ROD	230 x 1,9 x 22,23	25	3,10

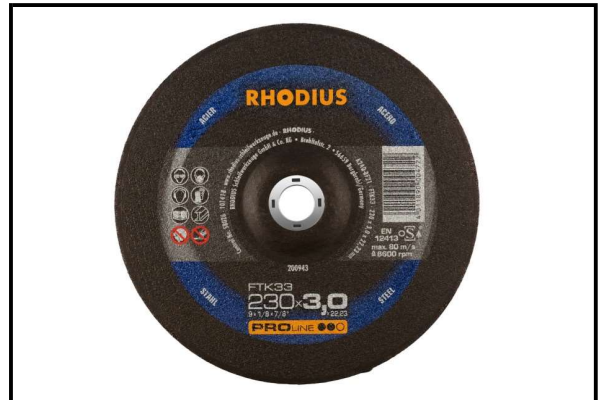

**Disco de Corte para Acero**

<b>Refer:</b>			<b>Precio €</b>
29200995-ROD	230 x 2,0 x 22,23	25	4,22
29200943-ROD	230 x 3,0 x 22,23	25	4,38

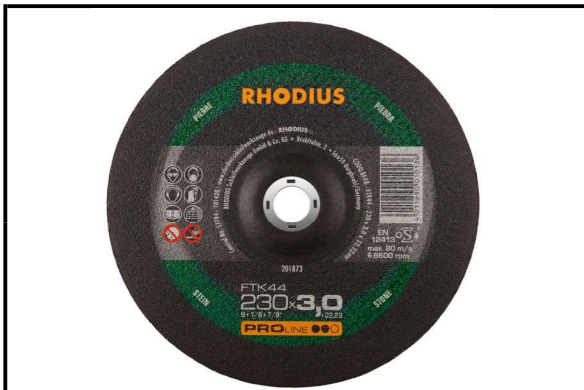

**Disco de Corte para Piedra**

<b>Refer:</b>			<b>Precio €</b>
29201873-ROD	230 x 3,0 x 22,23	25	4,23



**Disco Abrasivo de Polifibra**

<b>Refer:</b>			<b>Precio €</b>
76PFCD-TOM	115 x 22,23	10	8,99



**Disco de Láminas Abrasivo**

<b>Refer:</b>	<b>Grano</b>			<b>Precio €</b>
76393540-TOM	40	115 x 22,23	10	2,02
76393560-TOM	60	115 x 22,23	10	2,02
76393580-TOM	80	115 x 22,23	10	2,02
763935100-TOM	100	115 x 22,23	10	2,02
763935120-TOM	120	115 x 22,23	10	2,02
76393940-TOM	40	180 x 22,23	10	4,48
76393960-TOM	60	180 x 22,23	10	4,48



**Disco de Feltro Abrasivo**

<b>Refer:</b>			<b>Precio €</b>
76DLFEL-TOM	115 x 22,23	10	6,38

# TOMISA

# GRAPHITE

## Discos Diamante



General  
de obra

### SEGMENTADO

3057H616-TOP  
3057H619-TOP

Ø	€	
115 x 2,1	5,46 €	PVP
230 x 2,7	19,84 €	PVP



General  
de obra



### TURBO

57H625-TOP  
57H630-TOP

Ø	€	
115 x 2,4	5,86 €	PVP
230 x 3,1	20,39 €	PVP



Cerámica



Baldosas

### LISO

57H640-TOP  
57H646-TOP

Ø	€	
115 x 2,1	5,42 €	PVP
230 x 2,7	19,69 €	PVP



## DISCO 115 X 1 MM

Ref: 9422WA/50-MOR



## DISCO 115 X 1 MM

Ref: 9422ZA/10-MOR



## DISCO 230 X 1,9 MM

Ref: 9458ZA/25-MOR



¿PROBLEMAS CON LOS ATRANQUES?  
 ¡¡¡OLVÍDESE!!!

**COMETODO**  
 (DESATASCADOR DE DESAGÜES)



1 kg.                      2 kg.

**G.Q.A. PRODUCTOS DE CALIDAD**

**Desatascador De Desagües**

Refer:	Contenido		Precio €
5003/1-GQA	0,5 L # 1 Kilo	12	4,15
5003/2-GQA	1,0 L # 2 Kilos	8	7,15

¿PROBLEMAS CON LA CAL?  
 CALENTADORES, INTERCAMBIADORES DE CALOR, SERPENTINES, VERDÍN EN LAS PISCINAS, W.C. , MAMPARAS DE BAÑO, ETC...  
 ¿PROBLEMAS CON EL CEMENTO?  
 LIMPIADOR DE JUNTAS, GRESITE, HORMIGONERAS, PLANCHAS DE ENCOFRAO, GRES RÚSTICO, SALITRE, FRAGUADO, ETC...

¡¡¡OLVÍDESE!!!

**COMETODO**  
 (CEMENTO Y CAL)



1 l.                              5 l.

**G.Q.A. PRODUCTOS DE CALIDAD**

**Desincrustante para Cemento y Cal**

Refer:	Contenido		Precio €
806/1-GQA	1 Litro	8	4,15
806/5-GQA	5 Litros	4	18,16



**Desengrasante Multiusos**

Refer:	Contenido		Precio €
807/1-GQA	750 ml	8	5,10



**Ecogel Cucarachas en Jeringuilla**

Refer:

2809L100-PC

2809L035-PC

Contenido

5 gramos

10 gramos



12

12

Precio €

5,64

7,17

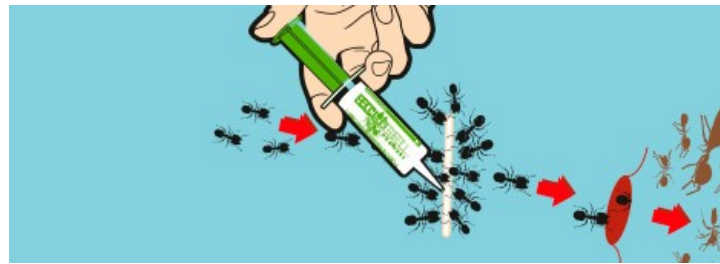

**Ecogel Hormigas en Jeringuilla**

Refer:

28094001-PC

Contenido

5 gramos



12

Precio €

5,64



**Ecogel Trampas Cucarachas y Hormigas**

Refer:	Contra	Contenido		Precio €
209191-PC	Cucarachas	15 gramos	6 x caja	5,61
209207-PC	Hormigas	15 gramos	3 x caja	5,61



**Raticida en Cebo Fresco y Bloque**

Refer:	Tipo	Contenido		Precio €
2810200-PC	Cebo Fresco	150 gramos	24	3,90
209068-PC	Bloque	300 gramos	12	8,49

GEBOTeC Professional		GT-GR08 GRASSO MULTIUSO	
<ul style="list-style-type: none"> <li>• ALTA VISCOSITÀ</li> <li>• PENETRA A FONDO NEGLI INGRANAGGI</li> </ul>		<p><b>ALTA VISCOSITÀ ANCHE IN CONDIZIONI DIFFICILI</b></p> <p>Fluido ad alta viscosità di elevata qualità ad alto potere penetrante. Buona stabilità chimica, ottima idrorepellenza e adesività. Protegge dall'acqua e dagli agenti atmosferici, resistente in ambienti salini polverosi, resistente alle soluzioni basiche ed acide. Ideale per la lubrificazione di cuscinetti, catene, linee di trasmissione, attrezzature marine, imbarcazioni, snodi, perni guide ed in generale nel settore degli autoveicoli, macchine agricole ed industriali, dispositivi di trasmissione ad alta velocità e ad alte temperature di esercizio. Penetra a fondo negli ingranaggi prolungandone la vita e l'efficienza.</p>	
<ul style="list-style-type: none"> <li>• MÁXIMA ADHERENCIA</li> <li>• PENETRA A FONDO EN LOS ENGRANAJES</li> </ul>		<p><b>GRASA DE PROTECCIÓN MÁXIMA ADHERENCIA - INCLUSO EN CONDICIONES EXTREMAS</b></p> <p>Fluido de alta viscosidad y gran calidad con alto poder de penetración. Buena estabilidad química, una excelente repelencia al agua y buena adherencia. Protege contra el agua y resiste a la intemperie en ambientes salinos, protege del polvo, es resistente a las soluciones ácidas y básicas. Ideal para la lubricación de los rodamientos, cadenas, líneas de transmisión, equipos marinos, vasos, juntas, pivotes, guías y en general en la maquinaria agrícola e industrial, aparatos para la transmisión de alta velocidad y altas temperaturas de funcionamiento. Penetra profundamente en los engranajes prolongando su vida útil y la eficiencia de los mismos.</p>	
<p><b>Grasa Multiuso en Spray</b></p> <p><u>Refer:</u> GT-GR08-GB</p>		<p><u>Contenido</u> 400 ml</p>	<p> 12</p> <p><u>Precio €</u> 7,47</p>

GEBOTeC Professional		GT-SB07 SBLOCCANTE RAPIDO	
<ul style="list-style-type: none"> <li>• MULTIUSO</li> <li>• ANTIRUGGINE</li> </ul>		<p><b>ANTIRUGGINE PROTETTIVO MULTIUSO</b></p> <p>Fluido sintetico ad alto potere solvente e sbloccante, libera rapidamente dadi, bulloni, giunti, filetti, serrature, lucchetti, cerniere, catene, attrezzature meccaniche e utensili manuali dalla ruggine e dalle ossidazioni. Forma inoltre un velo protettivo durevole, idrofuogo e idrorepellente. Prolunga la vita degli ingranaggi e ne previene l'usura.</p>	
<ul style="list-style-type: none"> <li>• MULTIUSOS</li> <li>• ANTI CORROSIÓN</li> </ul>		<p><b>DESBLOQUEO RÁPIDO PROTECCIÓN ANTI CORROSIÓN - MULTIUSOS</b></p> <p>Fluido sintético con alto poder disolvente y desbloqueante libera rápidamente tuercas, tornillos, juntas, hilos de rosca, cierrres, tornillería, bisagras, cadenas, equipo mecánico y herramientas de mano de la corrosión, herrumbre y oxidación. También forma una película resistente, impermeable, protectora y repelente al agua. Prolonga la vida útil de los engranajes y evita el desgaste prematuro.</p>	
<p><b>Desblocante Aflojatodo en Spray</b></p> <p><u>Refer:</u> GT-SB07-GB</p>		<p><u>Contenido</u> 400 ml</p>	<p> 12</p> <p><u>Precio €</u> 6,33</p>

**GEBOTeC**  
*Professional*

- LUBRIFICANTE PURÍSSIMO
- PER STRUMENTI E INGRANAGGI DI PRECISIONE
- LUBRIFICANTE PURO
- PARA LUBRICAR Y PROTEGER LOS ENGRANAJES DE PRECISIÓN

400 ml

**GT-VS11 OLIO DI VASELINA PURÍSSIMO**

**LUBRIFICANTE PROTETTIVO**

Inodore, incolore, non macchia. Ideale per lubrificare e proteggere strumenti di precisione, cerniere, serrature, attrezzi, ingranaggi, trasmissioni, macchine tessili e per ufficio, piani di scorrimento in linea e macchine a limentari, per usi professionali e domestici. Crea una pellicola fluida impermeabile ed elasticizzante sul legno evitandone le screpolature. Mantiene la pelle e il cuoio morbidi ed elastici. Adatto per metalli, gomma, legno, pelle e cuoio.

**ACEITE DE VASELINA LUBRIFICANTE DE PROTECCIÓN**

Sin olor, incoloro, no mancha. Ideal para lubricar y proteger las herramientas de precisión, bisagras, cerraduras, herramientas, engranajes, transmisiones, maquinaria textil para piel o cuero, maquinaria de oficina y líneas de maquinaria para alimentación, máquinas para usos profesionales y domésticos. Crea una película de fluido impermeable y elástica en la madera, evitando las grietas. Mantiene la piel, suavidad y elasticidad de la misma. Adecuado para metal, goma, madera, cuero y piel.

**Refer:**  
GT-VS11-GB

**Contenido**  
400 ml

12

**Precio €**  
5,88

**GEBOTeC**  
*Professional*

400 ml

**GT-SLIDER SCIVOLANTE-SCORRICAVO PER TUBI E CAVI ELETTRICI**

FACILITA IL MONTAGGIO E PROLUNGA LA VITA DEI MATERIALI

LUBE FOR PIPES AND CABLES  
LUBRICANTE - DESLIZA CABLES PARA CABLEADOS Y TUBOS  
FÜR ROHR- UND KABEL

Facilita el paso de cables eléctricos por las fundas. Para una correcta instalación sin atascos ni gripamientos. No daña las cubiertas de plástico ni tampoco las de cualquier goma además de proteger los cables del envejecimiento. Lubricante para el tendido de instalaciones eléctricas, telefonía y fibra óptica.

**Refer:**  
GT-SLIDER-GB

**Contenido**  
400 ml

12

**Precio €**  
7,67

GT-HQ09 SILICONE SPRAY HQ		Silicona Impermeabilizante en Spray	
Refer:	Contenido	Precio €	
GT-HQ09-GB	400 ml	6,52	

- EXTRA IMPERMEABILIZZANTE



- EXTRA IMPERMEABILIZACIÓN

**ALTA QUALITÀ - EXTRA PROTETTIVO IMPERMEABILIZZANTE**

Silicone spray ad alte prestazioni per l'industria plastica, gomma e taglio. Incolore, inodore, esente da solventi, temperatura di lavoro da -40° C a +250° C. Ideale come distaccante per gli stampi di materie plastiche. Protettivo e lubrificante, rilascia una pellicola impermeabile su ogni tipo di materiale trattando prevenendo l'accumulo di cariche elettrostatiche. Efficace come lucidante e protettivo sulle parti plastiche e protegge le guarnizioni da screpolature aumentando la tenuta e la durata. Utilizzato anche nei settori nautica, campeggio e per usi domestici. Non verniciabile.

**SILICONA HQ ALTA CALIDAD EXTRA PROTECCIÓN**

Silicona de alto rendimiento para la industria del plástico, el caucho y el corte. Incoloro, inodoro, libre de disolventes. apto para temperaturas de -40° C a +250° C. Ideal como agente antiadherente para moldes de plástico. Silicona de protección, lubricante a prueba de humedad, resistente al agua, impermeabilización para todo tipo de materiales. el silicio tiene una gran cantidad de funciones. También se puede utilizar en náutica, camping y el hogar. No se puede pintar.



12

400 ml



GT-RS12 RIMUOVI SILICONE		Eliminador de Silicona en Spray	
Refer:	Contenido	Precio €	
GT-RS12-GB	400 ml	6,94	

- RAPIDO
- NON AGGRESSIVO



- RÁPIDO
- NO AGRESIVO

**SOLVENTE RAPIDO NON AGGRESSIVO PER TUTTE LE SUPERFICI**

Formulazione a base di solventi adatti per sciogliere e rimuovere le eccedenze e i residui di silicone. Azione immediata sul silicone fresco, necessita di un breve tempo di reazione sul silicone indurito. In caso di una notevole quantità di silicone, si consiglia di asportarne meccanicamente il più possibile, prima di applicare il prodotto. Adatto per qualsiasi superficie. Non è aggressivo. Non opacizza.

**ELIMINA SILICONA DISOLVENTE RÁPIDO - NO AGRESIVO PARA TODAS LAS SUPERFICIES**

Formulación a base de disolventes adecuados para deshacer y eliminar el exceso de residuos de material y de silicona. El producto actúa rápidamente en presencia de silicona fresca, mientras que en las siliconas coaguladas actúa más lentamente. En el caso de una notable cantidad de silicona, antes de aplicar el producto retirar el máximo posible. Adecuado para cualquier superficie. No es agresivo. No empaña.



12

400ml





### LIMPIADOR ALTA PRESIÓN (AIRE COMPRIMIDO)

Elimina inmediatamente el polvo depositado en las superficies menos accesibles. Está indicado para la limpieza de lentes, objetivos, ordenadores, relojes y mecánica sensible a la suciedad.

**● LENTES, COMPUTADORAS, HERRAMIENTAS DE PRECISIÓN**



400ml





**Limpiador de Aire a Presión**

Refer:  
GT-AP-GB

Contenido  
400 ml

  
12

**Precio €**  
6,47



### PULIDOR CONTACTO ELECTRICO

Específico para la limpieza a fondo de contactos eléctricos, electrónicos y electromagnéticos. Elimina al instante la humedad y la suciedad presentes en la superficie a tratar como la grasa, aceite, cera, cola, dejando el área tratada limpia y libre de grasa. Si se utiliza sobre superficies delicadas, puede dañar las mismas.

**● EFICACIA INMEDIATA  
PROLONGA LA VIDA  
DEL CONTACTO ELECTRICO**



400ml





**Limpiador de Contactos Eléctricos**

Refer:  
GT-PE-GB

Contenido  
400 ml

  
12

**Precio €**  
6,10

<p>LUBRIFICANTE PER FILIERE</p> <p>LUBRIFICANTE PARA ROSCAR</p> <p>400ml</p>		<p><b>GEBOTec Professional</b></p> <p><b>GT-CUT10 OLIO DA TAGLIO PER FILIERE</b></p> <p><b>OLIO DA TAGLIO INTERO PER FILIERE</b></p> <p>Prodotto lubrificante innovativo di alta qualità ad azione protettiva per utensili e attrezzature di filiera. Progettato per applicazioni professionali specifiche nel settore della lavorazione e taglio dei metalli ad elevata durezza. GT-CUT10 è costituito da basi minerali paraffiniche arricchite con speciali additivi EP anti-saldami. Ideale per operazioni gravose di macchina e filettatura di acciai particolarmente duri e legati. Adatto anche per il settore idraulico.</p> <p><b>ACEITE DE CORTE PARA ROSCAR</b></p> <p>Producto lubricante de alta calidad para operaciones difíciles, de acción protectora sobre los utensilios. GT-CUT10 es un nuevo producto estudiado para aplicaciones profesionales específicas, en el sector del corte de metales de elevada dureza. El aceite utilizado tiene una composición a base de minerales parafínicos enriquecidos con aditivos especiales EP anti-adherivos. Ideal para operaciones difíciles de roscado en acero particularmente duro y en aleaciones. Especial para el sector hidráulico.</p>  	
<p><b>Aceite de Corte y Roscado</b></p>			
<p><u>Refer:</u> GT-CUT10-GB</p>	<p><u>Contenido</u> 400 ml</p>	<p> 12</p>	<p><u>Precio €</u> 6,85</p>

<p>500 ml</p>		<p><b>GEBOTec Professional</b></p> <p><b>GT-27 BRAKE &amp; GEAR CLEANER</b></p> <p>PULITORE PER FRENI E PARTI MECCANICHE</p> <p>LIMPIADOR FRENOS Y ENGRANAJES</p> <p>BREMSENREINIGER</p> <p><b>RAPIDO, SENZA RISCHIACQUO</b> QUICK, NO RINSING / RÁPIDO, SIN ENJUAGUE</p> <p><b>SCHNELL REINIGEND, OHNE RÜCKSTÄNDE ZU HINTERLASSEN</b></p> <p><b>LIMPIEZA DE FRENOS Y PARTES MECÁNICAS</b></p> <p>Detergente especial particularmente eficaz para frenos, embragues y todas las partes mecánicas que necesitan ser desengrasada sin enjuagar. Disuelve y elimina rápidamente aceite, grasa y cualquier otro tipo de suciedad. Especialmente adecuado para el engranaje alto rendimiento mecánico.</p> <p><b>● RAPIDO - SIN ACLARADO</b></p>  	
<p><b>Limpiador de Frenos y Engranajes</b></p>			
<p><u>Refer:</u> GT-27-GB</p>	<p><u>Contenido</u> 500 ml</p>	<p> 12</p>	<p><u>Precio €</u> 7,25</p>



400ml

### ANTIPROYECCIONES DE SOLDADURA

Producto a base de polímeros de película sintética, que por sus específicas propiedades impide el recalentamiento del cordón de soldadura en cualquier soporte. Otra película de agentes químicos impide la formación de corrosión. Es ideal para la soldadura autógena eléctrica y a base de gas inerte. El producto no contiene silicona.

**FILM DE PROTECCIÓN**



**Antisalpicaduras de Soldadura**

Refer:  
GT-SALD-GB

Contenido  
400 ml



12

Precio €  
6,25





Aerosol para galvanizar en frío con alto poder de protección y de adhesión de las superficies tratadas frente a la oxidación. Especialmente apto para el retoque profesional de superficies y productos galvanizados.

Alto poder de adhesión.

Seca rápidamente.

Acabado en espejo.



**Zincado Protector en Spray**

Refer:  
49BR400-VM

Contenido  
400 ml



12

Precio €  
6,15



De aplicación en los más diferentes sectores industriales.  
 Óptimas propiedades adhesivas, protectoras y deslizantes.  
 Penetra en profundidad y garantiza una lubricación duradera.  
 Reduce el coeficiente de fricción y desgaste.  
 Agitar el envase y rociar entre placas.

Apariencia: Pasta/ Blanco pálido

Densidad Relativa: 0,73 g/ml

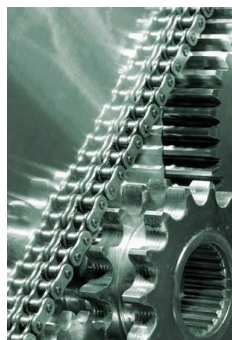

**Grasa de Litio + PTFE en Spray**

Refer:

82P400-VM

Contenido

400 ml



12

Precio €

5,46



Producto de alta calidad, indispensable para el profesional y el particular. Actúa con gran rapidez.

El suministro y la distribución del producto son regulables mediante una especial válvula de distribución.

Fácil de usar, el spray permite pegar materiales de diferente tipo, como metales, plástico, madera, materiales expandidos, vidrio y papel.

Áreas de Aplicación: Automoción, ferretería e industria, oficina, hidráulica y náutica.

Limpiar las superficies antes de aplicar y unir las partes presionando para mejor adherencia.



**Cola Adhesiva de Contacto en Spray**

Refer:

106P400-VM

Contenido

400 ml



12

Precio €

7,15



Permite un arranque rápido incluso a bajas temperaturas. Indicado para maquinaria agrícola y construcción, así como para barcos y vehículos de obra pública.

Areas de Aplicación: Automoción, ferretería e industria y náutica.

Aspecto: Líquido/Transparente, Incoloro  
Densidad Relativa: 0,70 g/ml



**Autoarranque Rápido para Motores**

Refer:

42P400-VM

Contenido

400 ml



12

**Precio €**

5,94



Un agente protector antiácido para bornes de batería, es el producto ideal para prevenir la sulfatación y la corrosión de los bornes de cobre o bronce. Resiste grandes variaciones de temperatura.

Areas de Aplicación: Automoción y náutica.

Aspecto: Líquido/Pastoso Color Rosa  
Densidad Relativa: 0,73 g/ml



**Protector de Bornes de Baterías**

Refer:

79P400-VM

Contenido

400 ml



12

**Precio €**

6,34



Aerosol seco ideal para lubricar todo tipo de cerraduras, candados y bisagras. Forma una película estable frente al calor y es conductora de electricidad. Se usa en los casos en que no se desea que haya aceites. Al lubricar, facilita el buen funcionamiento de piezas con riesgo de sufrir rayas y roces. Es ideal para cualquier tipo de mecanismo de deslizamiento, tales como guías, portones, cancelas basculantes y correderas. Se seca muy rápido. Es resistente al agua y los aceites. No retiene la suciedad ni el polvo. Resiste de -45° hasta 450°.

Areas de Aplicación: Automoción, ferretería e industria y náutica.





**Lubricante a base de Grafito**

Refer:  
93P200-VM

Contenido  
200 ml

  
12

**Precio €**  
4,45



Revestimiento protector a base de acero inoxidable micronizado con características anticorrosivas, idóneo para proteger y restablecer todo tipo de metales (acero, hierros, zincados, aluminio, etc.) Presenta una excelente adhesión y una vez que se seca, forma una película flexible, compacta y resistente que luego se puede pintar. Alta resistencia a agentes atmosféricos a los golpes, a los rayones, a la corrosión, y a los rayos ultravioleta. Limpiar bien cualquier zona oxidada.

Areas de Aplicación: Industria y náutica.





**Recubrimiento Inox en Spray**

Refer:  
33P400-VM

Contenido  
400 ml

  
12

**Precio €**  
8,26



Marcaje fluorescente profesional para obras de albañilería, madera, asfalto y pavimentaciones. Resistente a los agentes atmosféricos, el aerosol tiene una válvula especial de 360° para facilitar su empleo en cualquier posición.







Es una pintura de marcaje temporal que se degrada con el paso del tiempo para que no quede resto.

Aspecto: Líquido de Color

Densidad Relativa: 0,90 g/ml



### Marcadores de Obra Fluorescentes

<u>Refer:</u>	<u>Color</u>	<u>Contenido</u>		<u>Precio €</u>
64FLUO/AMA-VM		500 ml	12	6,58
64FLUO/AZU-VM		500 ml	12	6,58
64FLUO/NAR-VM		500 ml	12	6,58
64FLUO/ROJ-VM		500 ml	12	6,58
64FLUO/VER-VM		500 ml	12	6,58
64FLUO/FUX-VM		500 ml	12	6,58



Barniz de elevada calidad y alta capacidad de cobertura a base de resinas silicónicas modificadas.





Resistente a temperaturas hasta 600°.

Ideal para acabados y/o para renovar todas las superficies sujetas a elevadas temperaturas no expuestas a contacto directo con la llama como estufas, hogares, calderas, hornos, conductos de humo, barbacoas, colectores, silenciadores de escape, pinxas de freno, etc. El producto seca al aire pero para una correcta reticulación es necesaria la cocción a 100° por 10'.

Densidad Relativa: 0,9 g/ml



### Pintura Anticalórica Altas Temperaturas

<u>Refer:</u>	<u>Color</u>	<u>Contenido</u>		<u>Precio €</u>
100HTP4-VM	 Negro	400 ml	6	7,15
100HTDP4-VM	 Plata	400 ml	6	10,73
209058	 Antracita	400 ml	6	10,73



**Contenido**  
400 ml



Pintura acrílica de uso profesional y alta adhesividad. Ideal para las operaciones de pintura de materiales metálicos y plásticos. Producto de rápido secado, poder cubriente y sobrepintable. Realice siempre una prueba de compatibilidad del producto con el soporte a tratar.

Aspecto: Líquido de Color



**Pintura Acrílica en spray**

Refer:	Color	Descripción	Precio €	Refer:	Color	Descripción	Precio €	
RAL9005M-VM		Negro Mate	4,65	6	RAL5015-VM		Azul Cielo	4,65
RAL9005B-VM		Negro Brillo	4,65		RAL5017-VM		Azul Tráfico	4,65
RAL9005S-VM		Negro Satinado	4,65		RAL5005-VM		Azul Señal	4,65
RAL9003-VM		Blanco Señal	4,65		RAL2009-VM		Naranja Tráfico	4,65
RAL9010EL-VM		Blanco Electrodo	4,65		RAL3000-VM		Rojo Fuego	4,65
RAL9010B-VM		Blanco Brillo	4,65		RAL3020-VM		Rojo Tráfico	4,65
RAL9010S-VM		Blanco Satinado	4,65	RAL6029-VM		Verde Menta	4,65	
RAL9010M-VM		Blanco Mate	4,65	RAL6009-VM		Verde Abeto	4,65	
RAL8011-VM		Marrón Nuez	4,65	RAL6001-VM		Verde Esmeralda	4,65	
RAL1023-VM		Amarillo Tráfico	4,65	RAL7001-VM		Gris Plata	4,65	
				RAL7011-VM		Gris Hierro	4,65	



Limpiador efectivo para todas las instalaciones y equipos de oficina, como computadoras, impresoras, etc. Ideal para limpiar y desinfectar cualquier superficie en el hogar u oficina. Se evapora sin dejar ningún residuo. Elimina la suciedad y las cargas estáticas. Antes de la aplicación, se recomienda probar su compatibilidad con los materiales. No lo use en equipos activos, no opere el circuito antes de que el producto se haya evaporado por completo.

Áreas de Aplicación: Oficinas y hogar.



**Alcohol Isopropílico en spray**

Refer:	Contenido		Precio €
89P400-VM	400 ml	12	8,12



Lubricante protector con elevadas propiedades de penetración y limpieza. Adecuado para el mantenimiento de las partes mecánicas de armas en general. Inhibe el efecto corrosivo debido a las cenizas de la pólvora. Indispensable para el almacenaje. El producto tiene una función preventiva de lubricación y también después del uso, la de inhibir la formación de residuos de hollín.

Areas de Aplicación: Deporte, defensa, ferretería y armería.



**Aceite Lubricante para Armas**

Refer:

23P200-VM

Contenido

200 ml



12

Precio €

5,13



Lubricante antigripante para cadenas y piezas mecánicas de bicicletas con excelente penetración capaz de otorgar una lubricación de larga duración y una protección total. Reduce la fricción y el consumo de energía, repelente al agua. Permite un funcionamiento óptimo de todos los mecanismos de la bicicleta mejorando su rendimiento mecánico. Se puede aplicar a la cadena, palancas, cables y desviadores.

Areas de Aplicación: Deporte y ferretería.

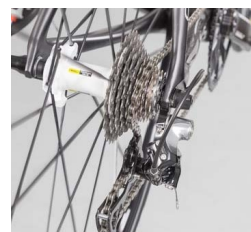

**Lubricante para Bicicletas**

Refer:

40P200-VM

Contenido

200 ml



12

Precio €

5,36



Elimina y previene la formación de malos olores creados por mohos, microorganismos Y moho en los sistemas de aire acondicionado industriales, civiles y de automóviles. Rocíe el producto directamente en los filtros o en el interior de los orificios durante pocos segundos por medio de la cánula, deje actuar durante algunos minutos hasta que se disuelva la espuma antes de encender la instalación. Evite que el producto entre en contacto con partes eléctricas.

Áreas de Aplicación: Automoción y ferretería.



**Higienizador Sistemas de Aire**

Refer:

159P400-VM

Contenido

400 ml



12

Precio €

4,82



Disolvente para eliminar restos de espuma poliuretánica fresca o de adhesivos. Se usa para limpiar la válvula de la bombona interior y exterior de la pistola de aplicación. También se usa en superficies metálicas para eliminar grasas, aceites, hollín, alquitrán, cera, etc.

Áreas de Aplicación: Montaje y ferretería.



**Limpiador Espuma de Poliuretano**

Refer:

105P500-VM

Contenido

500 ml



12

Precio €

6,58



Imprimación para una protección antioxidante y anticorrosiva de alta resistencia y elevado poder adhesivo. Resistente a los agentes atmosféricos y químicos agresivos. Producto sobrebarnizable, efectúe siempre una prueba de compatibilidad. Resistente a una temperatura de aproximadamente 100°C. Se aconseja desengrasar la superficie o eliminar barnices en mal estado antes de aplicar el esmalte.

Áreas de Aplicación: Industria y náutica.



### Imprimación Antióxido Gris

Refer:

100AR400-VM

Contenido

400 ml



Precio €

8,74

**Resina de Poliester altas Prestaciones**

Refer:	Contenido		Precio €
CC30-GB	300 ML	12	6,45
CC40-GB	410 ML	12	7,82
10CM12-TOM      Cánulas de Recambio	Bolsa con 12 uds		4,16

**Resina Híbrida altas Prestaciones**

Refer:	Contenido		Precio €
CC02-GB	300 ML	12	7,70
10CM12-TOM      Cánulas de Recambio	Bolsa con 12 uds		4,16

- \* Multiposición 360°
- \* Alto rendimiento de 40 L
- \* Cortable a los 30 minutos
- \* Almacenamiento 12 meses
- \* Fórmula de curado rápido
- \* Aislamiento acústico 60 db
- \* Aplicación 2 en 1 con cánula y pistola

**Espuma de Poliuretano para sellado, aislamiento y relleno**

<u>Refer:</u>	<u>Aplicación</u>	<u>Contenido</u>		<u>Precio €</u>
FM365-TOM	Cánula y Pistola	540 ML	12	7,09
AA210-TOM	Cánula de repuesto		1	0,90

Es adecuado para cubos, rodamientos, rodillos, engranajes, bisagras...  
 Garantiza una lubricación duradera de todos mecanismos que giran.  
 Resistente al agua y a la presión, adaptado a las condiciones exteriores, reduce la fricción al mismo tiempo que protege contra el óxido y la corrosión.  
 Libre de plomo y otros materiales nocivos para la salud.

**Grasa Litio Consistente Cartucho**

<u>Refer:</u>	<u>Color</u>	<u>Contenido</u>		<u>Precio €</u>
103400	Amarronado	400 G	9	6,80



Aplicable en húmedo



Resistente UV



Pintable

Sellador adhesivo elástico de Polímero MS especialmente formulado para el sellado y pegado de la mayoría de materiales utilizados en construcción. Excelente adhesión sobre metales, piedra, mármol, hormigón, cerámica, vidrio, espejos, madera, etc.

Aplicable en superficies húmedas. Pintable y sin olor.

Alta elasticidad. Resistente a los rayos U.V.

**Polímero MS Altas Prestaciones**

<u>Refer:</u>	<u>Color</u>	<u>Contenido</u>		<u>Precio €</u>
46002B	Blanco	280 ML	25	7,00
46003G	Gris	280 ML	25	7,00
46401T	Transparente	280 ML	25	7,72



Aplicable en húmedo



Resistente UV



Pintable

Sellador adhesivo elástico de Polímero MS especialmente formulado para el sellado y pegado de la mayoría de materiales utilizados en construcción. Excelente adhesión sobre metales, piedra, mármol, hormigón, cerámica, vidrio, espejos, madera, etc.

Aplicable en superficies húmedas. Pintable y sin olor.

Alta elasticidad. Resistente a los rayos U.V.

**Polímero MS TURBO pegado rápido**

**MS-TURBO AGARRE INMEDIATO**

<u>Refer:</u>	<u>Color</u>	<u>Contenido</u>		<u>Precio €</u>
46TURBO	Blanco	280 ML	12	7,72

# Novedad

## Espuma Poliuretano Manual 750 ml

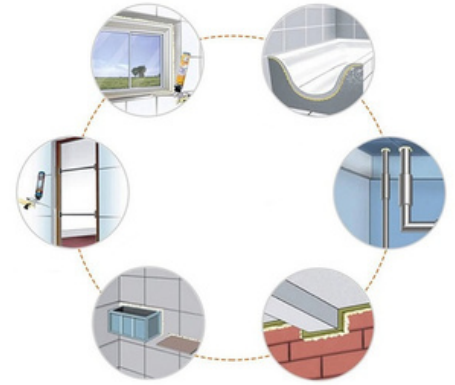
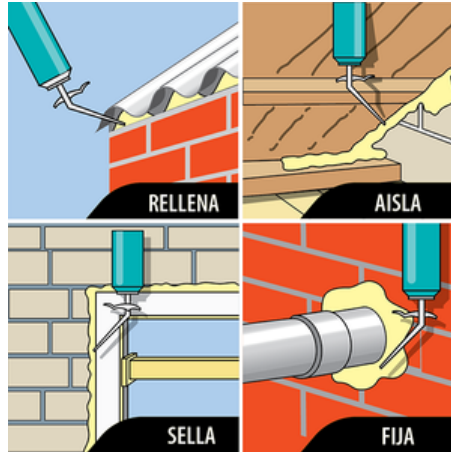

12





Ref: EPUB3M

### Principales usos y características de la espuma de poliuretano

- Excelente capacidad de adherencia sobre todas las superficies (excepto PE, PP, PTFE y siliconas).
- Alta capacidad de aislamiento térmico y acústico.
- Se expande y cura en contacto con humedad.
- Excelente resistencia a altas y bajas temperaturas.
- Temperatura de aplicación recomendada entre +5°C y +35°C.
- Caducidad: 18 meses.
- Rendimiento: 45 L.
- Color: beige.



**Bridas de Nylon Blancas y Negras**

<b>Blancas</b>		<b>Negras</b>		<b>Tamaño Ancho x Largo</b>			<b>Precio € Bolsa</b>
<b>Refer:</b>		<b>Refer:</b>					
5203-HON		5303-HON		2.5 x 100	100	50000	0,85
5201-HON		5301-HON		2.5 x 150	"	25000	1,31
5207-HON		5307-HON		2.5 x 200	"	25000	1,97
5208-HON		5308-HON		3.6 x 150	"	12500	2,21
5214-HON		5314-HON		3.6 x 200	"	15000	2,87
5211-HON		5311-HON		3.6 x 250	"	10000	3,77
5210-HON		5310-HON		3.6 x 300	"	10000	4,67
5213-HON				4.8 x 180	"	10000	2,65
5215-HON		5315-HON		4.8 x 200	"	10000	3,85
5216-HON		5316-HON		4.8 x 250	"	7500	5,00
5218-HON		5318-HON		4.8 x 300	"	5000	5,90
5219-HON		5319-HON		4.8 x 350	"	5000	6,89
5221-HON		5321-HON		4.8 x 400	"	5000	8,49
5222-HON		5322-HON		7.6 x 250	"	1500	11,11
5224-HON		5324-HON		7.6 x 300	"	2500	12,87
5226-HON		5326-HON		7.6 x 350	"	2500	16,15
5228-HON		5328-HON		7.6 x 450	"	1500	19,66
5236-HON		5336-HON		7.8 x 550	"	1000	21,40
5233-HON		5333-HON		7.6 x 750	"	1000	32,67
5238-HON		5338-HON		9 x 920	"	1000	48,22
5240-HON		5340-HON		9 x 1220	"	500	67,62

**Bridas de Nylon Verdes, Marrones, Grises y Azules**

<b>Verdes</b>	<b>Marrones</b>	<b>Grises</b>	<b>Azules</b>	<b>Tamaño Ancho x Largo</b>		<b>Precio € Bolsa</b>
<b>Refer:</b>	<b>Refer:</b>	<b>Refer:</b>	<b>Refer:</b>			
5203/V-HON				2.5 x 100	100	0,87
5208/V-HON				3.6 x 150	"	2,28
5214/V-HON	5214/M-HON	5214/G-HON	5214/AO-HON	3.6 x 200	"	2,95
5218/V-HON	5218/M-HON	5218/G-HON	5218/AO-HON	4.8 x 300	"	6,08

**Bases Atornillables para bridas**

Refer:	Medida	Máximo Brida	Color			Precio € Bolsa
5499/100B-HON	15 x 22 mm	7,8 mm	Blanco	100		5,32
5499/100N-HON	15 x 22 mm	7,8 mm	Negro	100		5,32

**Bases Adhesivas para Bridas Bi-Direccionales**

Refer:	Medida	Máximo Brida	Color			Precio € Bolsa
5473-ELM	26.5 x 26.5 mm	4,8 mm	Blanco	100		8,70
5475-ELM	26.5 x 26.5 mm	4,8 mm	Negro	100		8,70

**Tacos de Nylon para Bridas**

Refer:	Medida	Color				Precio € Bolsa
5456/100B-DE	6 x 34	Blanco	5000	100		4,51
5456/100N-DE	6 x 34	Negro	5000	100		4,51
5458/100B-HON	8 x 37	Blanco	5000	100		5,15
5458/100N-HON	8 x 37	Negro	5000	100		5,15
5458/100G-HON	8 x 37	Gris	5000	100		5,15



Con cogida para orificios

**Bridas de nylon con cogida para orificios**

Refer:	Medida	Color		Precio € Bolsa
52155/M-ELM	3.6 x 150	Blanco	100	5,82
52205/M-ELM	4.8 x 200	Blanco	100	8,91

**Bridas de nylon con DOBLE CIERRE**

Refer:	Medida	Color		Precio € Bolsa
6455-ELM	9.0 x 360	Negro	100	29,35
6456-ELM	9.0 x 510	Negro	100	65,98

**Vasos de 1/2" con puntas TORX**

Refer:	Medida	Precio €
2520-PR	20 x 55	4,30
2525-PR	25 x 55	4,30
2527-PR	27 x 55	4,30
2530-PR	30 x 55	4,30
2540-PR	40 x 55	4,30
2545-PR	45 x 55	4,30
2550-PR	50 x 55	4,30
2555-PR	55 x 55	4,30
2560-PR	60 x 55	4,95
2620-PR	20 x 100	4,60
2625-PR	25 x 100	4,60
2630-PR	30 x 100	4,60
2640-PR	40 x 100	4,60
2645-PR	45 x 100	4,60
2650-PR	50 x 100	5,52
2655-PR	55 x 100	5,52
2660-PR	60 x 100	7,83
3245/TXL70-ELO	70 x 140	17,90



**Vasos de 1/2" con puntas XZN**

Refer:	Medida	Precio €
2350-PR	5 x 55	4,30
2351-PR	6 x 55	4,30
2352-PR	8 x 55	4,30
2353-PR	10 x 55	4,30
2354-PR	12 x 55	4,60
2355-PR	14 x 55	5,20
2356-PR	16 x 55	5,95
2357/16-PR	16 x 55 Inviolable	7,44
2360-PR	6 x 100	4,60
2361-PR	8 x 100	4,60
2362-PR	10 x 100	4,60
2363-PR	12 x 100	8,10
2364-PR	14 x 100	8,10



**Vasos de 1/2" con puntas HEX**

Refer:	Medida	Precio €
2250-PR	4 x 55	4,30
2251-PR	5 x 55	4,30
2252-PR	6 x 55	4,30
2253-PR	7 x 55	4,30
2254-PR	8 x 55	4,30
2255-PR	10 x 55	4,30
2256-PR	12 x 55	4,60
2257-PR	14 x 55	4,65
2258-PR	17 x 55	4,70
2259-PR	19 x 55	5,54
2260-PR	5 x 100	4,60
2261-PR	6 x 100	4,60
2262-PR	7 x 100	4,60
2263-PR	8 x 100	4,60
2264-PR	10 x 100	4,75
2265-PR	12 x 100	4,80



**Puntas de 10 mm TORX**

Refer:	Medida
2520/A-PR	20 x 30
2525/A-PR	25 x 30
2527/A-PR	27 x 30
2530/A-PR	30 x 30
2540/A-PR	40 x 30
2545/A-PR	45 x 30
2550/A-PR	50 x 30
2555/A-PR	55 x 30
2560/A-PR	60 x 30
2620/A-PR	20 x 75
2625/A-PR	25 x 75
2630/A-PR	30 x 75
2640/A-PR	40 x 75
2645/A-PR	45 x 75
2650/A-PR	50 x 75
2655/A-PR	55 x 75
2660/A-PR	60 x 75

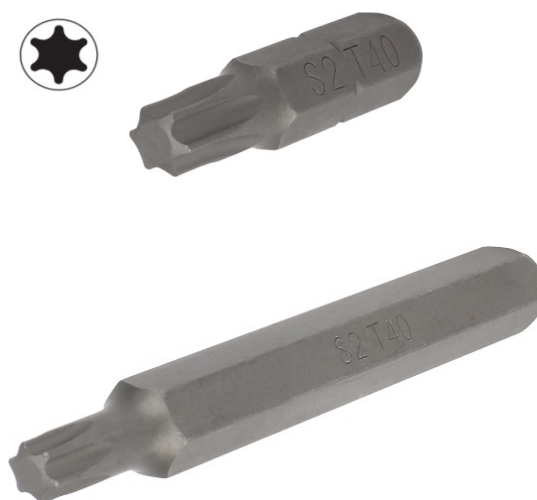

Precio €	
2,45	
2,45	
2,45	
2,45	
2,45	
2,45	
2,45	
2,45	
2,45	
3,10	
2,75	
2,75	
2,75	
2,75	
2,75	
2,75	
2,90	
3,65	
5,50	

**Puntas de 10 mm XZN**

Refer:	Medida
2350/A-PR	5 x 30
2351/A-PR	6 x 30
2352/A-PR	8 x 30
2353/A-PR	10 x 30
2354/A-PR	12 x 30
2355/A-PR	14 x 30
2359/A-PR	5 x 75
2360/A-PR	6 x 75
2361/A-PR	8 x 75
2362/A-PR	10 x 75
2363/A-PR	12 x 75
2364/A-PR	14 x 75

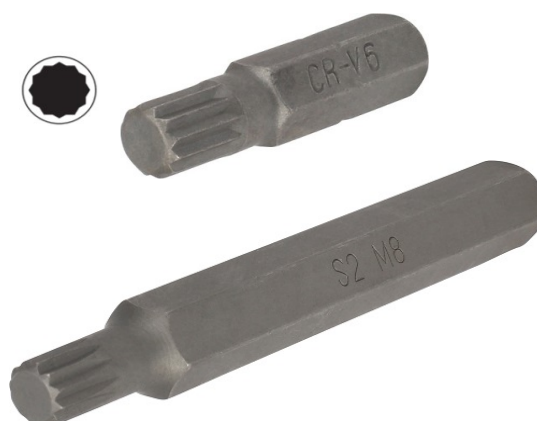

Precio €	
2,45	
2,45	
2,45	
2,45	
2,75	
3,35	
2,75	
2,75	
2,75	
2,75	
3,50	
3,98	

**Puntas de 10 mm HEX**

Refer:	Medida
2250/A-PR	4 x 30
2251/A-PR	5 x 30
2252/A-PR	6 x 30
2253/A-PR	7 x 30
2254/A-PR	8 x 30
2255/A-PR	10 x 30
2256/A-PR	12 x 30
2257/A-PR	14 x 30
2260/A-PR	5 x 75
2261/A-PR	6 x 75
2262/A-PR	7 x 75
2263/A-PR	8 x 75
2264/A-PR	10 x 75
2265/A-PR	12 x 75

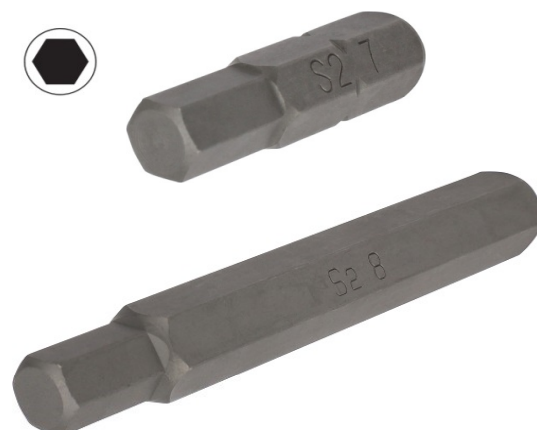

Precio €	
2,45	
2,45	
2,45	
2,45	
2,45	
2,45	
2,75	
2,90	
2,75	
2,75	
2,75	
2,75	
2,90	
4,38	

**Puntas de 10 mm TORX INVIOLABLES**

Refer:	Medida		Precio €
2825/A-PR	25 x 30	 	2,60
2827/A-PR	27 x 30		3,08
2830/A-PR	30 x 30		3,08
2840/A-PR	40 x 30		3,08
2845/A-PR	45 x 30		3,25
2850/A-PR	50 x 30		3,25
2855/A-PR	55 x 30		3,25
2860/A-PR	60 x 30		6,60
2881/A-PR	20 x 75	 	3,08
2881/1A-PR	25 x 75		3,08
2882/A-PR	30 x 75		3,08
2883/A-PR	40 x 75		3,08
2884/A-PR	45 x 75		3,60
2885/A-PR	50 x 75		3,60
2886/A-PR	55 x 75		5,22
2887/A-PR	60 x 75		6,90
2888/A-PR	70 x 75		6,90

**Puntas de 10 mm RIBE**

Refer:	Medida		Precio €
18075/6-PR	6 x 75	 	3,10
18075/8-PR	8 x 75		3,10
18075/10-PR	10 x 75		3,10
18075/12-PR	12 x 75		4,82

**Vasos de 1/4" con puntas TORX**

Refer:	Medida		Precio €
2510/B-PR	10 x 37	 	2,31
2515/B-PR	15 x 37		2,31
2520/B-PR	20 x 37		2,31
2525/B-PR	25 x 37		2,31
2527/B-PR	27 x 37		2,31
2530/B-PR	30 x 37		2,31
2540/B-PR	40 x 37		2,31

**Vasos de 1/4" con puntas ALLEN**

Refer:	Medida		Precio €
2503/B-PR	3 x 37	 	2,31
2504/B-PR	4 x 37		2,31
2505/B-PR	5 x 37		2,31
2506/B-PR	6 x 37		2,31

**Vasos de 1/4" con puntas PH y PZ**

Refer:	Medida		Precio €
257673-PR	PH-1 x 37		2,31
257674-PR	PH-2 x 37		2,31
257676-PR	PZ-1 x 37	 	2,31
257677-PR	PZ-2 x 37		2,31

**Puntas de atornillador de 1/4 x 25**
**Phillips**

64000/10T-WH	PH-1 x 25	TIN
64010/10T-WH	PH-2 x 25	"
64020/10T-WH	PH-3 x 25	"



	Precio €
10	1,20
10	1,20
10	1,20

**Pozidrive**

64100/10T-WH	PZ-1 x 25	TIN
64110/10T-WH	PZ-2 x 25	"
64120/10T-WH	PZ-3 x 25	"



10	1,20
10	1,20
10	1,20

**Phillips**

64000/10-WH	PH-1 x 25
64010/10-WH	PH-2 x 25
64020/10-WH	PH-3 x 25



10	0,65
10	0,65
10	0,65

**Pozydrive**

64100/10-WH	PZ-1 x 25
64110/10-WH	PZ-2 x 25
64120/10-WH	PZ-3 x 25
64130/10-WH	PZ-4 x 25



10	0,65
10	0,65
10	0,65
10	1,98

**Phillips**

R062/1-WH	PH-1 x 25	Impacto
R062/2-WH	PH-2 x 25	"



4	1,45
4	1,45

**Pozydrive**

R063/1-WH	PZ-1 x 25	Impacto
R063/2-WH	PZ-2 x 25	"



4	1,45
4	1,45

**Planas**

22/3-BIA	Plana 3.0 x 0.5
22/4-BIA	Plana 4.0 x 0.5
22/55-BIA	Plana 5.5 x 0.8
22/65-BIA	Plana 6.5 x 1.2



10	0,70
10	0,70
10	0,70
10	0,70

**Puntas de atornillador de 1/4 x 25**
**Hex**

3010/IN2-WH	Hex 2 x 25
3010/IN25-WH	Hex 2.5 x 25
3010/IN3-WH	Hex 3 x 25
3010/IN4-WH	Hex 4 x 25
3010/IN5-WH	Hex 5 x 25
3010/IN6-WH	Hex 6 x 25
3010/IN8-WH	Hex 8 x 25

**Precio €**

10	0,70
10	0,70
10	0,70
10	0,70
10	0,70
10	0,75
8	1,90

**Torx Normales**

64040/T05-WH	T-05 x 25
64040/T06-WH	T-06 x 25
64040/T07-WH	T-07 x 25
64040/T08-WH	T-08 x 25
64040/T09-WH	T-09 x 25
64040/T10-WH	T-10 x 25
64040/T15-WH	T-15 x 25
64040/T20-WH	T-20 x 25
64040/T25-WH	T-25 x 25
64040/T27-WH	T-27 x 25
64040/T30-WH	T-30 x 25
64040/T40-WH	T-40 x 25



10	1,10
10	1,10
10	1,10
10	1,10
10	1,10
10	0,95
10	0,95
10	0,95
10	0,95
10	0,95
10	0,95
10	0,95

**Torx Inviolables**

64069/TX10-WH	T-10 x 25
64069/TX15-WH	T-15 x 25
64069/TX20-WH	T-20 x 25
64069/TX25-WH	T-25 x 25
64069/TX27-WH	T-27 x 25
64069/TX30-WH	T-30 x 25
64069/TX40-WH	T-40 x 25



10	1,75
10	1,75
10	1,75
10	1,75
10	1,75
10	1,75
10	1,75

**Cuadradas**

64040/C2-VO	Cuadrada 2 x 25
-------------	-----------------



10	0,83
----	------

**Puntas de atornillador 1/4 x 50**

					<b>Precio €</b>
<b>Phillips</b>					
64300/10-WH	PH-1 x 50			10	1,10
64310/10-WH	PH-2 x 50			10	1,10
<b>Pozydrive</b>					
64350/10-WH	PZ-1 x 50			10	1,10
64360/10-WH	PZ-2 x 50			10	1,10
<b>Phillips Impacto</b>					
R062/150-WH	PH-1 x 50			2	2,19
R062/250-WH	PH-2 x 50			2	2,19
<b>Pozydrive Impacto</b>					
R063/150-WH	PZ-1 x 50			2	2,19
R063/250-WH	PZ-2 x 50			2	2,19
<b>Torx</b>					
64110/T10-BIA	T-10 x 50			10	3,13
64120/T20-BIA	T-20 x 50			10	3,13
64125/T25-BIA	T-25 x 50			10	3,13
<b>Hex</b>					
4110/IN2-BIA	Hexagonal 2 x 50			10	1,92

**Puntas de atornillador 1/4 x 100**

					<b>Precio €</b>
<b>Refer:</b>					
64312-WH	PH-1 x 100			5	5,24
64311-BIA	PH-2 x 100			5	5,24
64351-WH	PZ-1 x 100			5	5,24
64361-BIA	PZ-2 x 100			5	5,24

**Puntas de atornillador PH-2 con tope**

					<b>Precio €</b>	
<b>Refer:</b>						
3006040	PH-2 x 25	2 uds			10	3,07
El tope metálico evita que el tornillo se embuta en la superficie atornillada sin dañarla.						

**Puntas Mixtas de 1/4" x 25, 33 pzs.**

**Refer:**  
**308-PR**

- Hex Inviolables: 5/32, 9/64, 1/8, 7/64, 3/32, 5/64
- Hex Inviolables: 2, 2.5, 3, 4, 5, 6
- Tri Wing: 1, 2, 3, 4
- Torq Set: 6, 8, 10
- Spanner: 4, 6, 8, 10
- Torx Inviolable: T8, T10, T15, T20, T25, T27, T30, T35, T40
- Adaptador magnético de 1/4" x 60 mm



**Precio €**  
8,08



12

**Vasos y Puntas Mixtas de 1/4" x 25, 24 pzs.**

**Refer:**  
**101130-TOM**

- Planas: 4, 6
- PH: 1, 2
- PZ: 1, 2
- Hex: 3, 4, 5, 6
- Torx Inv: 10, 15, 20, 25, 30, 40
- Llaves vaso 1/4": 6, 7, 8, 10, 11, 13
- Adaptador magnético para puntas 1/4"
- Adaptador 1/4" para llaves de vaso
- Mini carraca reversible para puntas 1/4"



**Precio €**  
21,25



12

**Puntas Mixtas de 1/4" x 25, 32 pzs.**

**Refer:**  
**101044-TOM**

- Planas: 4, 6
- PH: 1, 2
- PZ: 1, 2
- Hex: 3, 4, 5, 6
- Torx Inv: 10, 15, 20, 25, 30, 40
- Adaptador magnético para puntas 1/4"
- Adaptador 1/4" para llaves de vaso



**Precio €**  
16,38



12



**Adaptador Magnético de 1/4"**

Refer:	↔	Precio €
64201-WH	60 mm	2,20
64200-WH	100 mm	3,95



**Adaptador Magnético de 1/4" Impacto**

Refer:	↔	Precio €
R067-WH	60 mm	5,52



**Adaptador Magnético de 1/4" SDS**

Refer:	↔	Precio €
64202-TOM	75 mm	5,36



**Adaptador Magnético de 1/4"**

Refer:	↔	Precio €
3006071	60 mm	7,48

*Regulable*



**Adaptadores Magnéticos de 1/4"**

Refer:	↔	Precio €
3006072	150 mm	13,10
3006073	300 mm	19,63



**Adaptador Magnético Flexible de 1/4"**

Refer:	↔	Precio €
967217-WH	300 mm	11,48



### Adaptadores Magnéticos Hexagonales

Refer:	Medida		Precio €
64400-VO	1/4 x 50 (6.35)	Sin Imán	3,57
64420-VO	3/8 x 50 (9.52)	Sin Imán	3,57
64451-WH	1/4 x 65 (6.35)		4,49
1501-YT	6 x 50 x 1/4		2,21
1502-YT	7 x 50 x 1/4		2,21
1503-YT	8 x 50 x 1/4		2,21
64531/B-WH	8 x 65 x 1/4	Blíster	4,70
1505-YT	10 x 50 x 1/4		2,37
64540/B-WH	10 x 65 x 1/4	Blíster	4,70
1507-YT	12 x 50 x 1/4		3,55
1508-YT	13 x 50 x 1/4		3,78
64543/B-WH	13 x 65 x 1/4	Blíster	4,99
1510-YT	17 x 65 x 1/4		5,10



### Juego de Adaptadores Magnéticos, 5 pzs.



**Refer:** 1500-TOM **Precio €** 9,80

Medidas: 7 - 8 - 10 - 12 - 13 mm x 65 mm





### Adaptador Hembra - Hembra 1/4 x 1/4

**Refer:** 20624-PR   25 mm **Precio €** 1,53

Para uso con carraca de 1/4" y puntas de atornillador

**Juego de Adaptadores de 1/4", 3 pzs.**

**Refer:**  
4703-TOM

**Precio €**  
4,69

Para llaves de vaso de: 1/4", 3/8" y 1/2"

**Juego de Adaptadores Sds Plus, 3 pzs.**

**Refer:**  
550743

**Precio €**  
5,81

Para llaves de vaso de: 1/4", 3/8" y 1/2"

**Adaptadores 1/4" Portavasos 1/4", 2 pzs.**

**Refer:**  
20626-TOM  
20627-TOM

**Precio €**  
2,86  
3,74

Blister con 2 uds

↔  
25 mm  
50 mm

**Adaptador 1/4" Portavasos 1/2"**

**Refer:**  
550732

**Precio €**  
2,66

Blister con 2 uds

↔  
70 mm

**Tornillo Tirafondo tipo Barraquero Cincado**

<u>Refer:</u>	<u>Medida</u>		<u>Precio €</u>
			<u>Caja</u>
695030Z-VO	5 x 30	100	4,10
695040Z-VO	5 x 40	100	4,98
696040Z-VO	6 x 40	200	11,96
696050Z-VO	6 x 50	200	13,94
696060Z-VO	6 x 60	200	15,12
696070Z-VO	6 x 70	100	11,72
696080Z-VO	6 x 80	100	11,95
697040Z-VO	7 x 40	100	9,48
697050Z-VO	7 x 50	100	9,99
697060Z-VO	7 x 60	100	11,92
697070Z-VO	7 x 70	100	12,10
697080Z-VO	7 x 80	100	16,36
698040Z-VO	8 x 40	100	10,50
698050Z-VO	8 x 50	100	12,94
698060Z-VO	8 x 60	100	13,75
698070Z-VO	8 x 70	100	16,58
698080Z-VO	8 x 80	100	18,14
698090Z-VO	8 x 90	100	19,04
6980100Z-VO	8 x 100	50	10,98
6980120Z-VO	8 x 120	50	13,96
691060Z-VO	10 x 60	50	15,65
691070Z-VO	10 x 70	50	16,71
691080Z-VO	10 x 80	50	17,17
6910100Z-VO	10 x 100	50	18,30
6910120Z-VO	10 x 120	50	19,15



**DIN 571**

**Tornillo Rosca Madera cabeza ALOMADA Pozidrive Cincado**

<u>Refer:</u>	<u>Medida</u>		<u>Precio €</u>
			<u>Caja</u>
643016/Z-VO	3 x 16	200	4,33
643020/Z-VO	3 x 20	200	4,99
644030/Z-VO	4 x 30	200	6,27
644040/Z-VO	4 x 40	200	7,33
644530/Z-VO	4,5 x 30	200	9,48
644535/Z-VO	4,5 x 35	200	11,43
644540/Z-VO	4,5 x 40	200	12,77
645050/Z-VO	5 x 50	200	17,31



**Tornillo Rapid Lastro cabeza ALOMADA Phillips con punta de broca Cincado**

<u>Refer:</u>	<u>Medida</u>		<u>Precio €</u>	
				<u>Caja</u>
724213/Z-VO	4,2 x 13	500		12,21
724219/Z-VO	4,2 x 19	500		16,24
724225/Z-VO	4,2 x 25	500		17,40

**Tornillo auto taladrante cabeza ALOMADA Phillips con punta de broca Cincado**

<u>Refer:</u>	<u>Medida</u>			<u>Precio €</u>	
					<u>Caja</u>
743595/Z-VO	3,5 x 9,5	1000		11,94	
743513/Z-VO	3,5 x 13	1000		14,93	
743516/Z-VO	3,5 x 16	1000		18,95	
744216/Z-VO	4,2 x 16	1000		21,34	
744219/Z-VO	4,2 x 19	1000		22,66	
744225/Z-VO	4,2 x 25	500		12,23	
744232/Z-VO	4,2 x 32	1000		33,70	
744819/500Z-VO	4,8 x 19	500	Cuadrada	7,98	
744819/Z-VO	4,8 x 19	1000		28,50	
744825/Z-VO	4,8 x 25	1000		39,85	
744832/ZQ-VO	4,8 x 32	500		21,32	
744838/ZQ-VO	4,8 x 38	500		24,22	
744845/ZQ-VO	4,8 x 45	500		26,70	
744880/Z-VO	4,8 x 80	250		23,88	
7448100/Z-VO	4,8 x 100	100		15,92	

**DIN 7504-N**
**Tornillo auto taladrante cabeza PLANA Phillips con punta de broca Cincado**

<u>Refer:</u>	<u>Medida</u>		<u>Precio €</u>	
				<u>Caja</u>
753513/Z-VO	3,5 x 13	1000		12,45
753516/Z-VO	3,5 x 16	1000		13,34
753519/Z-VO	3,5 x 19	1000		16,20
753525/Z-VO	3,5 x 25	500		8,66
754213/Z-VO	4,2 x 13	1000		17,99
754216/Z-VO	4,2 x 16	1000		17,31
754219/Z-VO	4,2 x 19	1000		21,46
754225/Z-VO	4,2 x 25	500		13,20
754232/ZQ-VO	4,2 x 32	500		15,25
754819/Z-VO	4,8 x 19	1000		28,50
754825/Z-VO	4,8 x 25	500		15,47
754832/ZQ-VO	4,8 x 32	500		20,04
754838/Z-VO	4,8 x 38	500		22,04
754845/ZQ-VO	4,8 x 45	500		29,00

**DIN 7504-P**

**Tornillo Autotaladrante Cabeza Hexagonal + Arandela EPDM**

<u>Refer:</u>	<u>Medida</u>		<u>Precio €</u>	
			<u>Caja</u>	
734819/ZQ-VO	4,8 x 19	1000	52,08	
734825/ZQ-VO	4,8 x 25	1000	64,59	
735522/ZQ-VO	5,5 x 22	1000	67,94	
735525/ZQ-VO	5,5 x 25	1000	70,03	
735532/ZQ-VO	5,5 x 32	1000	78,18	
735550/ZD-VO	5,5 x 50	500	52,70	
735563-VO	5,5 x 63	250	33,27	
736350-TOM	6,3 x 50	250	34,36	
736375-VO	6,3 x 75	250	46,86	
7363100-VO	6,3 x 100	100	30,07	
7363120-VO	6,3 x 120	100	37,67	



**DIN 7504-K**
**Arandela EPDM de Acero Galvanizado**

<u>Refer:</u>	<u>Medida</u>		<u>Precio €</u>	
			<u>Caja</u>	
714814-TOM	P14 x 4,8	500	15,50	
715516-TOM	P16 x 5,5	500	16,07	
716318-TOM	P18 x 6,3	500	18,11	
716325-TOM	P25 x 6,3	500	36,96	

**DIN 7711**
**Tornillo Fosfatado para "Pladur" con rosca normal**

<u>Refer:</u>	<u>Medida</u>		<u>Precio €</u>	
			<u>Caja</u>	
653625/F-VO	3,6 x 25	1000	15,40	
653635/F-VO	3,6 x 35	1000	19,59	
653645/F-VO	3,6 x 45	500	12,96	
653655/F-VO	3,6 x 55	500	15,45	

**Tornillo Inviolable Cincado**

<u>Refer:</u>	<u>Medida</u>		<u>Precio €</u>	
			<u>Caja</u>	
787070	7 x 70	100	22,37	
787090	7 x 90	100	30,93	



Especialmente indicado para la colocación de rejillas, vallas y barandillas.

**Tornillos Rosca Madera con cabeza Pozidrive Bicromatado**
**Refer:**

66...

Medida		€ Caja
2,6 x 12	1000	9,73
2,6 x 16	1000	9,95
3 x 12	200	2,70
3 x 16	200	2,93
3x16x0,5	200	2,70
3 x 20	200	2,84
3 x 25	200	3,62
3 x 30	200	4,16
3 x 35	200	4,40
3 x 40	200	4,93
3,5 x 12	200	3,16
3,5 x 16	200	3,02
3,5 x 20	200	3,27
3,5 x 25	200	3,67
3,5 x 30	200	4,15
3,5 x 30	200 TX	4,15
3,5 x 35	200	4,62
3,5 x 40	200	5,58
3,5 x 45	200	6,22
3,5 x 50	200	6,86

Medida		€ Caja
4 x 16	200	3,59
4 x 20	200	3,59
4 x 25	200	3,98
4 x 30	200	4,07
4 x 35	200	5,02
4 x 40	200	5,34
4 x 45	200	6,53
4 x 50	200	6,77
4 x 60	200	8,77
4 x 70	200	10,68
4,5 x 16	200	5,05
4,5 x 20	200	5,27
4,5 x 25	200	5,75
4,5 x 30	200	5,90
4,5 x 35	200	6,70
4,5 x 40	200	6,86
4,5 x 45	200	7,65
4,5 x 50	200	8,53
4,5 x 60	200	10,13
4,5 x 70	200	14,50
4,5 x 80	200	19,13

Medida		€ Caja
5 x 20	200	6,05
5 x 25	200	6,20
5 x 30	200	6,62
5 x 35	200	7,34
5 x 40	200	8,21
5 x 45	200	9,25
5 x 50	200	9,63
5 x 60	200	11,28
5 x 70	200	13,42
5 x 80	200	15,90
5 x 90	200	22,23
5 x 100	200	25,53
6 x 30	100	6,33
6 x 40	100	6,47
6 x 50	100	7,45
6 x 60	100	9,06
6 x 70	100	10,62
6 x 80	100	12,31
6 x 90	100	15,65
6 x 100	100	15,45
6 x 110	100	19,84
6 x 120	100	18,78
6 x 130	100	25,48
6 x 140	100	27,79
6 x 150	100	34,21
6 x 160	100	39,24
6 x 180	100	56,24
6 x 200	100	71,06

**DIN 7505-A**
**Tornillos de Media Rosca para Madera con cabeza Pozidrive Bicromatado**
**Refer:**

Refer:	Medida		€ Caja
684040/MB-VO	4 x 40/24	1000	23,00
684050/QB-VO	4 x 50/30	500	14,65
684550/QB-VO	4,5 x 50/30	500	17,87
684560/QB-VO	4,5 x 60/36	500	21,80

**DIN 7505-A**

**Destornilladores Extra Largos**



Refer:	Tipo Varilla x Largo Varilla x Largo Total		Precio €
384503-WH	Plana 6,5 x 1.2 mm x 400 x 510		11,51
3845061-WH	Phillips PH-2 x 400 x 510		11,51



**Destornillador 1/4" Flexible**

Refer:	Descripción	Dimensiones		Precio €
1719/3-WH	Cuadrado para vasos de 1/4"	1/4" x 160 x 270		7,65





**Destornillador 1/4" Mango Recto**

Refer:	Descripción	Dimensiones		Precio €
21117-PR	Cuadrado para vasos de 1/4"	1/4" x 60 x 150		3,98





**Juego Destornillador 1/4" Flexible con Puntas y Vasos, 31 pzs.**

Refer:	Descripción		Precio €
3039D865-TOP	Insertión hembra para puntas de 1/4"		16,90

**Destornillador Porta-puntas de 1/4" magnético Eco**

<b>Refer:</b> 3039D860-TOP	<u>Varilla x largo</u> 1/4 x 100 x 215	Mango ergonómico bimaterial		 12	<b>Precio €</b> 3,28
-------------------------------	---	-----------------------------	---	---	-------------------------



**Destornillador Porta-puntas de 1/4" magnético Pro**

<b>Refer:</b> 961173-WH	<u>Tipo de Varilla</u> 1/4 x 100 x 210	Mango ergonómico bimaterial		 10	<b>Precio €</b> 7,56
----------------------------	---	-----------------------------	---	---	-------------------------



**Destornillador Porta-puntas Corto de 1/4" magnético**

<b>Refer:</b> 1717/5-WH	<u>Tipo de Varilla</u> 1/4 x 38 x 118	Mango ergonómico bimaterial		 10	<b>Precio €</b> 9,99
----------------------------	--	-----------------------------	---	---	-------------------------

**Destornillador Portavasos y Puntas 1/4" (2 en 1)**

<b>Refer:</b> 16124-WH					<b>Precio €</b> 10,48
---------------------------	--	--	--	--	--------------------------





  
10

**Destornilladores de Vaso HEXAGONAL mango recto**



Refer:	Medida x Largo	Precio €	Refer:	Medida x Largo	Precio €
216/4-WH	Vaso de 4 x 210 mm	6,95	216/9-WH	Vaso de 9 x 235 mm	9,50
216/45-ELO	Vaso de 4.5 x 210 mm	6,95	216/10-WH	Vaso de 10 x 245 mm	9,60
216/5-WH	Vaso de 5 x 225 mm	7,10	216/11-WH	Vaso de 11 x 245 mm	9,75
216/55-WH	Vaso de 5.5 x 225 mm	7,10	216/12-WH	Vaso de 12 x 245 mm	9,95
216/6-WH	Vaso de 6 x 235 mm	7,36	216/13-WH	Vaso de 13 x 245 mm	10,30
216/7-WH	Vaso de 7 x 235 mm	7,66	216/14-WH	Vaso de 14 x 245 mm	10,65
216/8-WH	Vaso de 8 x 235 mm	7,87	216/1/4-ELO	Vaso de 1/4" x 210 mm	6,44

**Destornillador Reversible Profesional 6 en 1**



Refer:  
968602-WH

Precio €  
13,76



Ph 1-2-3



Plano 4-5-6



**Destornillador Carrocero Portapuntas 1/4"**



Refer:  
968808-WH

Precio €  
7,76



Pz 1-2-3



Ph 1-2-3



Plano 6,5





**Destornilladores ALLEN mango "T"**

Refer:	Hexagonal	Precio €
156/H025-FLY	Varilla 2,5 mm x 100 mm	5,32
156/H03-FLY	Varilla 3 mm x 100 mm	5,72
156/H04-FLY	Varilla 4 mm x 150 mm	6,05
156/H05-FLY	Varilla 5 mm x 150 mm	6,44
156/H06-FLY	Varilla 6 mm x 150 mm	7,26
156/H08-FLY	Varilla 8 mm x 200 mm	8,35



**Destornilladores ALLEN BOLA mango "T"**

Refer:	Hexagonal con BOLA	Precio €
157/HB03-FLY	Varilla 3 mm x 100 mm	5,83
157/HB04-FLY	Varilla 4 mm x 150 mm	6,22
157/HB05-FLY	Varilla 5 mm x 150 mm	6,60
157/HB06-FLY	Varilla 6 mm x 150 mm	7,76



**Mini-Destornilladores Mixtos, 6 pzs**

Refer:	Medidas	Precio €
3164553-YT	1.4, 2.4, 3, Ph1, Ph0, Ph00	8,68



**Mini-Destornilladores Torx, 6 pzs**

Refer:	Medidas	Precio €
3164554-YT	Tx5, Tx6, Tx7, Tx8, Tx9, Tx10	8,25



**Destornillador en "T" con Vasos y Puntas, 21 pzs**

Refer:	Precio €
65100-YT	4,59

- 5, 6, 7, 8, 9, 10, 11, 12, 13 mm
- 3, 4, 5, 6, 8 mm
- PH1, PH2, PH3
- T15, T20, T30

10

**Destornilladores mango "T" varilla INVOLABLE + varilla larga NORMAL**

Refer:	Varilla x largo	Precio €
762/TI09-FLY	Varilla 09x100x12	6,56
762/TI10-FLY	Varilla 10x100x12	6,56
762/TI15-FLY	Varilla 15x100x12	6,56
762/TI25-FLY	Varilla 25x150x14	7,98
762/TI27-FLY	Varilla 27x150x14	7,98
762/TI30-FLY	Varilla 30x150x14	7,98



**Destornilladores TORX mango "T"**

Refer:	Varilla x largo	Precio €
762/TX30-ELO	Varilla T-30 x 125	7,07
762/TX45-ELO	Varilla T-45 x 125	10,19
762/TX50-ELO	Varilla T-50 x 125	11,02

*Hasta fin de existencias*



**Destornilladores XZN mango "T"**

Refer:	Varilla x largo	Precio €
158/XZN04-FLY	Varilla 4 x 100	7,02
158/XZN05-FLY	Varilla 5 x 100	7,74
158/XZN06-FLY	Varilla 6 x 100	7,74
158/XZN08-FLY	Varilla 8 x 150	9,18
158/XZN10-FLY	Varilla 10 x 150	12,12



**Destor TORX Inviolable mango "T"**

Refer:	Varilla x largo	Precio €
764/TI09-FLY	Varilla 09 x 100	7,02
764/TI10-FLY	Varilla 10 x 100	7,02
764/TI15-FLY	Varilla 15 x 100	7,02
764/TI20-FLY	Varilla 20 x 100	7,06
764/TI25-FLY	Varilla 25 x 100	7,74
764/TI27-FLY	Varilla 27 x 100	7,74
764/TI30-FLY	Varilla 30 x 100	7,74
764/TI40-FLY	Varilla 40 x 100	8,64

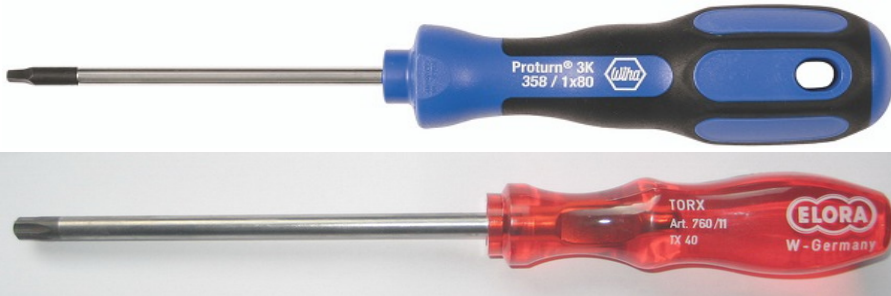

**Destornilladores TORX mango recto**

Tools that work for you

Refer:	Medida	Marca		Precio €
760/TX25-ELO	T-25 x 100 x 207	Wiha	10	5,64
760/TX30-ELO	T-30 x 115 x 200	Elora	6	4,95
760/TX40-ELO	T-40 x 130 x 235	Elora	6	7,15
760/TX45-ELO	T-45 x 130 x 235	Elora	6	7,67

**Destornilladores TORX Inviolable Mango Bi-Material**

Refer:	Medida		Precio €
1374/T05I-WH	T-5 x 60	10	3,60
1374/T06I-WH	T-6 x 60	10	3,70
1374/T07I-WH	T-7 x 60	10	3,85
1374/T08I-WH	T-8 x 60	10	3,90
1374/T09I-WH	T-9 x 60	10	3,95
1374/T10I-WH	T-10 x 80	10	4,00
1374/T15I-WH	T-15 x 80	10	4,05
1374/T20I-WH	T-20 x 100	10	4,10
1374/T25I-WH	T-25 x 100	10	4,20
1374/T30I-WH	T-30 x 115	10	4,75
1374/T40I-WH	T-40 x 130	10	5,95

**Destornillador de GOLPE con 6 puntas**

Refer: 224/4-PR 8 y 10 Cortas **Precio €**  
10 Larga 20,24



2 y 3 Cortas  
3 Larga



**Puntas 6 pzs**

Refer: 224/B-PR **Precio €**  
4,23







Destornilladores PZ y PH



Refer:	Varilla	Pala / Varilla / Total		 12	Precio €
3039D830-TOP	Pozydrive	PZ 1 x 100 x 200		12	2,58
3039D831-TOP	Pozydrive	PZ 2 x 100 x 210		12	3,14
3039D820-TOP	Phillips	PH 0 x 75 x 165		12	2,00
3039D821-TOP	Phillips	PH 1 x 100 x 200		12	2,50
3039D823-TOP	Phillips	PH 2 x 100 x 210		12	3,14





Destornilladores Planos

Refer:	Varilla	Pala / Varilla / Total		 12	Precio €
3039D801-TOP	Plana	3,2 x 75 x 165		12	2,00
3039D802-TOP	Plana	4 x 100 x 190		12	2,42
3039D804-TOP	Plana	5 x 100 x 200		12	2,58
3039D806-TOP	Plana	6,5 x 150 x 260		12	3,25

Destornilladores de Carrocero

<b>Refer:</b> 3039D803-TOP	<b>Tipo de Varilla</b> Plana 5 x 38	 12		<b>Precio €</b> 2,59
 <b>Refer:</b> 3039D822-TOP	<b>Tipo de Varilla</b> PH 2 x 38	 12		<b>Precio €</b> 2,28

**Juego Destor. Ph - Planos, 6 pzs.**

**Refer:** 3039D886-TOP **Precio €** 17,01

- Destor Plano 5 x 38
- Destor Plano 5 x 100
- Destor Plano 6,5 x 150
- Destor PH 1 x 100
- Destor PH 2 x 38
- Destor PH 2 x 150

**Destornilladores Aislados**

Refer:	Varilla	Pala / Varilla / Espesor		📦	Precio €
3039D470-TOP	Plana	2,5 x 75 x 0,4	Topex	12	3,31
3039D471-TOP	Plana	3 x 100 x 0,6	Topex	12	3,39
3039D472-TOP	Plana	4 x 100 x 0,8	Topex	12	4,29
3039D473-TOP	Plana	5,5 x 125 x 1,0	Topex	12	6,71

**Destornilladores Aislados**

Refer:	Varilla	Pala / Varilla / Total		📦	Precio €
3039D475-TOP	Phillips	PH 0 x 60 x 150	Topex	12	3,24
3039D476-TOP	Phillips	PH 1 x 80 x 195	Topex	12	4,47
3039D477-TOP	Phillips	PH 2 x 100 x 220	Topex	12	6,32
1522/3150-WH	Phillips	PH 3 x 150 x 270	Whirlpower	10	6,07



**Portabrocas Angular 90° para Taladro**

**Refer:**  
3055H932

**Ø**  
0,8 mm - 10 mm

**Precio €**  
35,95

Cogida hexagonal de 8 mm  
Para uso con atornilladores a batería y taladros eléctricos.  
Con giro a derecha e izquierda.  
Permite trabajar en zonas de difícil acceso.



**Adaptador Angular para puntas de 1/4"**

**Refer:**  
3055H931

**Precio €**  
21,07

Permite atornillado con ángulo a 90°.  
Para uso con atornilladores a batería y taladros eléctricos.  
Equipado con transmisión de rodamiento de bolas.

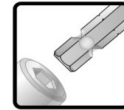

**Adaptador Sds Max a Sds Plus**

**Refer:**  
7030-TOM

**Precio €**  
25,72

Permite trabajar con útiles Sds Plus en martillos Sds Max.



**Tuerca Ajuste Rápido M14**

**Refer:**  
4160-TOM

**Precio €**  
14,63

Permite ajustar manualmente los discos en la amoladora

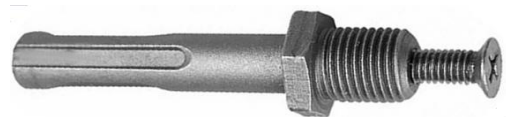

**Adaptador SDS Plus a 1/2" x 20 UNF**

**Refer:**  
4140-TOM

**Precio €**  
2,85

Acople de portabrocas en taladros sds plus



**Llaves para Taladro**

Refer:	Ø	Precio €
4071/1-TOM	1 - 10 mm	1,15
4072-TOM	1 - 13 mm	1,49
4073-TOM	1 - 16 mm	1,95



**Portabrocas Rápido Mini Hex 1/4"**

Refer:	Ø	Precio €
4180-TOM	0,5 mm - 6,5 mm	10,47



**Portabrocas 13 mm Automático**

Refer:	Ø	Precio €
4100/B-TOM	1/2" x 20 UNF	7,90



**Portabrocas 13 mm + Llave Taladro + Adap Sds**

Refer:	Ø	Precio €
4070/3-TOM	1/2" x 20 UNF	9,91



**Portabrocas 13 mm + Llave Taladro**

Refer:	Ø	Precio €
4070-TOM	1/2" x 20 UNF	6,96



**Portabrocas Metálico + Adap Sds Plus**

Refer:	Ø	Precio €
4080-TOM	1/2" x 20 UNF	23,01



**Portabrocas Metálico Profesional**

Refer:	Ø	Precio €
4050-TOM	1/2" x 20 UNF	19,55



Formones con mango de plástico		
Refer:	Medidas	Precio €
3009A108-TOP	8 mm	3,82
3009A110-TOP	10 mm	3,94
3009A112-TOP	12 mm	4,09
3009A115-TOP	15 mm	4,41
3009A120-TOP	20 mm	5,03
3009A125-TOP	25 mm	4,86

mm  
250

10



Escofinas para Madera M/ Bimaterial		
Refer:		Precio €
3006A831	Plana 	4,44
3006A832	Media Caña 	4,44
3006A833	Redonda 	4,22

mm  
200

10





Juego de Limas, 3 pzs.		Precio €
Refer:		
3006A230-TOP	  	12,23

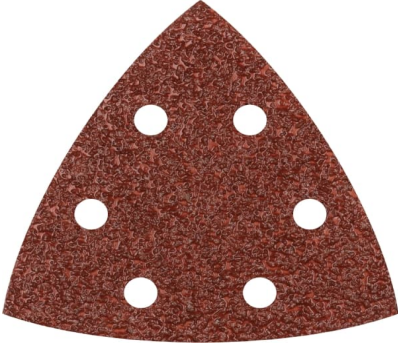

Juego de Formones, 4 pzs.		
Refer:	Medidas	Precio €
3009A310-TOP	6 x 125 x 250	19,68
	12 x 125 x 250	
	18 x 125 x 250	
	24 x 125 x 250	









96 mm

**Lija Delta Velcro Abrasiva**

Refer:	Grano		Precio € Caja
3040-KL	40	50	32,53
3060-KL	60	50	29,74
3080-KL	80	50	24,74
30100-KL	100	50	24,74
30120-KL	120	50	24,74
30150-KL	150	50	24,74
30180-KL	180	50	24,74
30240-KL	240	50	24,74

Materiales: Madera - Pintura - Laca - Masilla - Metal



98 x 148 mm

**Lija Mouse Velcro Abrasiva**

Refer:	Grano		Precio € Caja
5040-KL	40	50	33,98
5060-KL	60	50	27,26
5080-KL	80	50	23,48
50100-KL	100	50	23,48
50120-KL	120	50	23,48

Materiales: Madera - Pintura - Laca - Masilla









150 mm

**Lija Circular Velcro Abrasiva**

Refer:	Grano		Precio € Caja
4060-KL	60	50	52,24
4080-KL	80	50	47,88
40100-KL	100	50	44,10
40120-KL	120	50	44,10
40150-KL	150	50	44,10
40180-KL	180	50	44,10
40220-KL	220	50	44,10

Materiales: Madera - Pintura - Laca - Masilla - Metal



230 x 280 mm

**Lija Pliego Papel Abrasiva**

Refer:	Grano		Precio € Caja
2060-KL	60	50	32,57
2080-KL	80	50	30,95
20100-KL	100	50	27,82
20120-KL	120	50	27,82
20180-KL	180	50	27,82
20240-KL	240	50	28,15
20320-KL	320	50	28,15

Materiales: Madera - Pintura - Laca - Masilla - Metal - Cuero - Plástico

**Lija Pliego Tela Abrasiva, 10 pzs**

<u>Refer:</u>	<u>Grano</u>		<u>Precio € Paquete</u>
3008A422-TOP	40	10	5,20
3008A424-TOP	60	10	5,20
3008A426-TOP	80	10	5,20
3008A428-TOP	100	10	5,20
3008A430-TOP	120	10	5,20



230 x 280 mm

Materiales: Madera - Pintura - Laca - Masilla - Metal



### Coronas Diamantadas M-14 para Porcelánico

Refer:	Ø	Precio €
9006-TOM	6 mm	11,98
9008-TOM	8 mm	12,15
9010-TOM	10 mm	12,50
9012-TOM	12 mm	12,95
9015-TOM	15 mm	13,50
9020-TOM	20 mm	15,95
9025-TOM	25 mm	17,70
9030-TOM	30 mm	21,15
9032-TOM	32 mm	22,77
9035-TOM	35 mm	24,70
9040-TOM	40 mm	28,15
9050-TOM	50 mm	35,15
9060-TOM	60 mm	42,15
9068-TOM	68 mm	47,70

M14

seco

diamante

amoladora

porcelánico - gres - marmol

uso



### Adaptador Hexagonal a rosca M14

Refer:	Precio €
4150-TOM	5,51

M14

HEX

Permite trabajar con útiles M14 en taladros manuales





**Juego Accesorios Sds Plus, 3 pzs**

Refer:	Precio €
101106-TOM	13,82

Cinzel - Pala - Puntero  
x 250 mm





**Juego Accesorios Sds Max, 3 pzs**

Refer:	Precio €
101107-TOM	29,61

Cinzel - Pala - Puntero  
x 400 mm

Coronas Construcción M-22 TCT para Hormigón		
Refer:	Ø	Precio €
9240-TOM	40 mm	13,41
9245-TOM	45 mm	14,98
9250-TOM	50 mm	16,06
9255-TOM	55 mm	17,66
9260-TOM	60 mm	18,72
9265-TOM	65 mm	19,79
9270-TOM	70 mm	20,87
9275-TOM	75 mm	23,55
9280-TOM	80 mm	24,62
9290-TOM	90 mm	32,13
92100-TOM	100 mm	38,94
92120-TOM	120 mm	51,40



Husillos Sds Plus para Coronas M-22		
Refer:	↔	Precio €
93110-TOM	110 mm	9,92
93220-TOM	220 mm	11,65
93350-TOM	350 mm	13,59







Broca Guía centradora para Coronas M-22		
Refer:	Ø	Precio €
9308110-TOM	8 x 110 mm	1,92







**Puntero Sds Plus 18 mm construcción**

Refer: 94250-TOM ↔ 250 mm Precio € 6,38



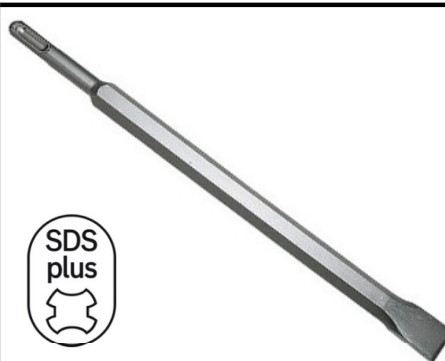
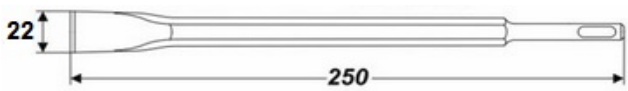

**Cinzel Sds Plus Plano 22 mm construcción**

Refer: 9422250-TOM ↔ 250 mm Precio € 7,26



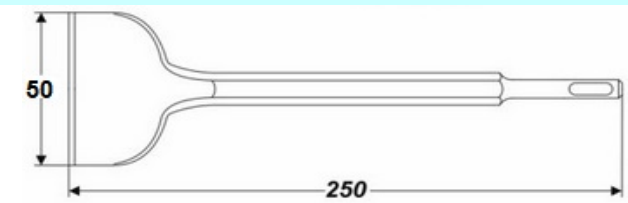

**Pala Sds Plus Ancha 50 mm construcción**

Refer: 9450250-TOM ↔ 250 mm Precio € 9,35





**Cinzel Sds Plus Hueco Acanalado construcción**

Refer: 9414250-TOM ↔ 250 mm Precio € 7,01

<b>Puntero Sds Max 18 mm construcción</b>		<b>Precio €</b>
 	<b>Refer:</b> 9518400-TOM	<b>400 mm</b>
	 	

<b>Cinzel Sds Max Plano 25 mm construcción</b>		<b>Precio €</b>
 	<b>Refer:</b> 9525400-TOM	<b>400 mm</b>
	 	

<b>Pala Sds Max Ancha 50 mm construcción</b>		<b>Precio €</b>
 	<b>Refer:</b> 9550400-TOM	<b>400 mm</b>
	 	





# VIKING



### Coronas HSS Bi-Metal Cobalto 8% para Madera, Metal y Plástico

Refer:	Medidas	Precio €	Refer:	Medidas	Precio €
9114-MO	14.3 mm # 9/16"	6,87	9157-MO	57.2 mm # 2 1/4"	11,94
9116-MO	15.9 mm	6,84	9159-MO	58.7 mm # 2 5/16"	11,94
9117-MO	17.5 mm # 11/16"	6,84	9160-MO	60.3 mm # 2 3/8"	13,17
9119-MO	19 mm # 3/4"	6,84	9162-MO	62 mm	13,17
9120-MO	20 mm	6,84	9164-MO	63.5 mm # 2 1/2"	13,17
9121-MO	20.7 mm # 13/16"	6,84	9165-MO	65.1 mm # 2 9/16"	13,17
9122-MO	22.2 mm # 7/8"	6,84	9167-MO	66.7 mm # 2 5/8"	13,17
9124-MO	23.8 mm # 15/16"	7,20	9168-MO	68 mm	13,17
9125-MO	25.4 mm # 1"	7,20	9170-MO	69.9 mm # 2 3/4"	13,32
9127-MO	27 mm # 1 1/16"	7,20	9173-MO	73 mm # 2 7/8"	13,32
9129-MO	28.6 mm # 1 1/8"	7,20	9175-MO	75 mm	13,32
9130-MO	30 mm	7,20	9176-MO	76.2 mm # 3"	13,32
9132-MO	31.8 mm # 1 1/4"	7,29	9179-MO	79.4 mm # 3 1/8"	13,32
9133-MO	33 mm # 1 5/16"	7,29	9183-MO	82.6 mm # 3 1/4"	13,81
9135-MO	34.9 mm # 1 3/8"	7,71	9186-MO	85.7 mm # 3 3/8"	13,81
9137-MO	36.5 mm # 1 7/16"	7,71	9189-MO	88.9 mm # 3 1/2"	13,81
9138-MO	38.1 mm # 1 1/2"	7,71	9192-MO	92.1 mm # 3 5/8"	15,90
9140-MO	39.7 mm # 1 9/16"	7,71	9195-MO	95.3 mm # 3 3/4"	15,90
9141-MO	41.3 mm # 1 5/8"	7,71	9198-MO	98.4 mm # 3 7/8"	18,50
9143-MO	42.9 mm # 1 11/16"	7,71	91100-MO	100 mm	19,17
9144-MO	44.5 mm # 1 3/4"	9,60	91102-MO	102 mm # 4"	19,82
9145-MO	45 mm	9,60	91105-MO	104.8 mm # 4 1/8"	19,82
9146-MO	46 mm # 1 13/16"	9,60	91111-MO	111.1 mm # 4 3/8"	30,99
9148-MO	47.6 mm # 1 7/8"	9,60	91114-MO	114.3 mm # 4 1/2"	32,28
9150-MO	50 mm	9,60	91121-MO	120.7 mm # 4 3/4"	34,34
9151-MO	50.8 mm # 2"	9,60	91127-MO	127 mm # 5"	36,92
9152-MO	52.4 mm # 2 1/16"	11,94	91133-MO	133 mm	37,45
9154-MO	54 mm # 2 1/8"	11,94	91140-MO	139.7 mm # 5 1/2"	39,16
9155-MO	55 mm	11,94	91146-MO	146 mm # 5 3/4"	41,01
			91152-MO	152.4 mm # 6"	43,45



### Juego de Coronas BI-METAL Cobalto 8%

Refer: **91S125-TOM** Precio € **57,59**

Especial para **FONTANEROS** y **ELECTRICISTAS**

Coronas: 16 - 20 - 25 - 32 - 40 - 50 mm

Husillos: 9134C - 9135PS

En maletín de PVC rígido



**Husillos para coronas BI-METAL**



**Refer:** 9134C-MO **Precio €** 9,13

Husillo para coronas de 14 a 30 mm  
Rosca 1/2 UNF  
Cogida hexagonal de 9,5 mm



**Refer:** 9135PS-MO **Precio €** 12,20

Husillo para coronas de 32 a 250 mm  
Rosca 5/8 UNF  
Cogida hexagonal de 9,5 mm



**Refer:** 9147SDS-MO **Precio €** 17,30



Husillo para coronas de 32 a 250 mm  
con sistema de roscado y pivotes  
Cogida SDS PLUS



**Brocas Centradoras para Husillos**

Refer:	Medida	Precio €
99MPD/4S-TOM	6,35 x 80	2,72
99MPD/4N01-TOM	6,35 x 100	3,25



**Broca Fregaderos**

Refer:	Ø	Precio €
1270/32-UPO	32 mm	21,70
1270/35-UPO	35 mm	23,95

Especial para Acero Inoxidable  
Acero: 2 mm de espesor  
Aluminio: 5 mm de espesor

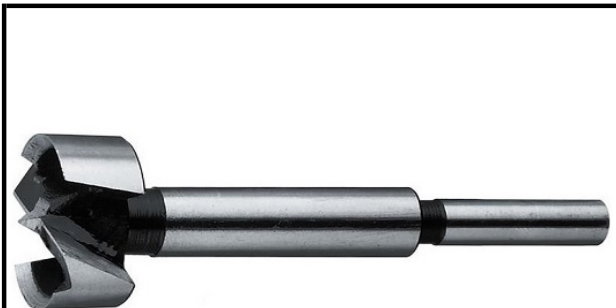

**Fresa para Madera**

Refer:	Ø	Precio €
445/26-TOM	26 mm	9,50
445/35-TOM	35 mm	9,80

Especial bisagras de cazoleta  
en muebles de cocina



**Brocas de Sierra Campana múltiples**

<u>Refer:</u>	<u>Hojas</u>	<u>Precio €</u>
670-GUO	Corta 1" - 2,5 mm	3,82
671-GUO	Larga 2" - 5 mm	5,03
	26, 32, 38, 45, 50, 56 y 63 mm	
28725	Grande 40 mm de hoja	10,29
	60, 67, 74, 81 y 95 mm	

Calidad Bricolage



**Cortador de Circulos Ajustable**

<u>Refer:</u>	<u>Precio €</u>
672	9,60

Ø Regulable 40 - 200 mm

Escayola - Pladur - Madera - Plástico

\*Especial para focos tipo downlight\*



**Juego de Coronas de Tungsteno, 8 pzs**

<u>Refer:</u>	<u>Precio €</u>
502-TOM	45,62

Ø 33 - 53 - 67 - 73 - 83 mm

Azulejos - Cerámica - Ladrillo

Incluye Broca guía Ø 8 mm





**Discos Abrasivos Mini, 10 pzs**

**Refer:**  
55H071

Ø 20 mm

**Precio €**  
5,74



**Discos de Corte Mini, 10 pzs**

**Refer:**  
55H072

Ø 32 mm

**Precio €**  
6,72



**Ruedas Mini Lijadoras, 11 pzs**

**Refer:**  
55H069

Ø 6,3 mm x Gr 60-120

**Precio €**  
4,48



**Soportes Mini para Discos, 2 pzs**

**Refer:**  
55H074

Eje 3,2 mm

**Precio €**  
3,16



**Fresas Mini Abrasivas, 2 pzs**

**Refer:**  
55H062

Ø 3,2 mm Multimaterial

**Precio €**  
5,10



**Brocas Mini Precisión, 7 pzs**

**Refer:**  
55H075

Ø 0,8 - 1,2 - 1,6 - 2 - 2,4 - 3,2

**Precio €**  
6,02



**Fresas Mini Abrasivas, 3 pzs**

<b>Refer:</b>		<b>Precio €</b>
55H056	Ø 6 mm x 10 mm	4,48
55H057	Ø 10 mm x 20 mm	4,82



**Fresas Mini Abrasivas, 3 pzs**

<b>Refer:</b>		<b>Precio €</b>
55H051	Ø 5 mm x 10 mm	4,48
55H052	Ø 10 mm x 12 mm	4,82



**Cepillos Mini Pulidores, 15 pzs**

<b>Refer:</b>		<b>Precio €</b>
55H078	Ø 5 - 15 - 22 - 25 mm	10,56



**Ruedas Mini Abrasivas, 24 pzs**

<b>Refer:</b>		<b>Precio €</b>
55H081	Ø 6,3 x 12,7 mm / 16 x 32 mm	10,56



**Cepillos Mini Abrasivos, 3 pzs**

<b>Refer:</b>		<b>Precio €</b>
55H066	Ø 5 - 15 - 20 mm	4,48



**Juego de Accesorios Mini Taladro, 100 pzs**

<b>Refer:</b>		<b>Precio €</b>
3050G029-TOP		22,25

Cepillos, lijas, piedras de amolar, pulidores, pasta de pulir, discos de corte

Hojas de Calar para: Bosch - AEG - Metabo - Casals - Hitachi

Refer: 3106-MPS		<b>3106</b> <b>MPS</b> « wood » <b>Classic - Line</b> <small>Made in Germany</small> <b>CV</b>	Precio € <u>Blíster</u> 4,24

Refer: 3104-MPS		<b>3104</b> <b>MPS</b> « wood » <b>Profi - Line</b> <small>Made in Germany</small> <b>CV</b>	Precio € <u>Blíster</u> 5,14

Refer: 3101-MPS		<b>3101</b> <b>MPS</b> « wood » <b>Profi - Line</b> <small>Made in Germany</small> <b>CV</b>	Precio € <u>Blíster</u> 6,37

Refer: 3102-MPS		<b>3102</b> <b>MPS</b> « wood » <b>Profi - Line</b> <small>Made in Germany</small> <b>CV</b>	Precio € <u>Blíster</u> 6,58

Refer: 3104XL-MPS		<b>3104-XLS</b> <b>MPS</b> « wood » <b>Profi - Line</b> <small>Made in Germany</small> <b>CV</b>	Precio € <u>Blíster</u> 9,15

Refer: 3109-MPS		<b>3109</b> <b>MPS</b> « wood » <b>Classic - Line</b> <small>Made in Germany</small> <b>CV</b>	Precio € <u>Blíster</u> 5,95

<b>Refer:</b> 3111-MPS	 <p>3111 MPS « metal » Classic - Line HSS Made in Germany</p>	Fino 1,2 mm x 50 mm x 21 t.p.i.	(T118A)	Metal	<b>Precio €</b>
					<b>Blister</b> 6,21

<b>Refer:</b> 3114-MPS	 <p>3114 MPS « metal » Classic - Line HSS Made in Germany</p>	Fino 1.2 x 110 mm x 21 t.p.i.	(T318A)	Metal Larga	<b>Precio €</b>
					<b>Blister</b> 10,19

<b>Refer:</b> 3159F-MPS	 <p>3159-F MPS « metal » Profi-Top-Line Made in Germany BiMetal</p>	Fino 1.4 x 180 mm x 18 t.p.i.	(T718BF)	Metal Extra Larga	<b>Precio €</b>
					<b>Blister</b> 19,38

<b>Refer:</b> 3150FKR-MPS	 <p>3150-FKR MPS wood metal Profi - Top-Line Made in Germany Bi-Metal</p>	Doble 1.8-2.5 x 110 mm x 10-14 t.p.i.	Metal - Madera	<b>Precio €</b>
				<b>Blister</b> 17,29

<b>Refer:</b> 3121-MPS	 <p>3121 MPS Profi-Line HM</p>	Carburos de Tungsteno x 50 mm	Blister con 1 und	<b>Precio €</b>
				<b>Blister</b> 4,63

## Hojas de Calar para: Black &amp; Decker - Hitachi - Milwaukee

Refer: 3406-MPS		3406 MPS «wood» Classic - Line Made in Germany CV	(U111C)	Madera	Precio €
					Blister 5,09
Semi-gueso 3 mm x 75 mm x 8 t.p.i.					

Refer: 3404-MPS		3404 MPS «wood» Profi - Line Made in Germany CV	(U144D)	Madera	Precio €
					Blister 5,72
Grueso 4 mm x 75 mm x 6 t.p.i.					

Refer: 3401-MPS		3401 MPS «wood» Profi - Line Made in Germany CV	(U101B)	Aglomerado	Precio €
					Blister 7,75
Semi-gueso 2,5 mm x 75 mm x 10 t.p.i.					

Refer: 3406L-MPS		3406-L MPS «wood» Classic - Line Made in Germany CV	(U101B)	Madera	Precio €
					Blister 6,63
Semi-fino 4 x 110 mm x 6 t.p.i.					

Refer: 3402-MPS		3402 MPS «wood» Profi - Line Made in Germany CV	(U101BR)	Madera Con Diente hacia adelante	Precio €
					Blister 7,70
Semi-fino 2.5 x 75 mm x 10 t.p.i.					

Refer: 3409-MPS		3409 MPS «wood» Classic - Line Made in Germany CV	(U101BR)	Madera - Plástico	Precio €
					Blister 5,95
Fino 2 x 60 mm x 12 t.p.i.					

Refer:  
3411-MPS



Fino 1,2 mm x 50 mm x 21 t.p.i.

(U118A)

Metal

Precio €  
Blister  
7,34

Refer:  
3414-MPS



Fino 1.2 x 110 mm x 21 t.p.i.

(U318A)

Metal Larga

Precio €  
Blister  
10,19



**Hojas de Sierra de Sable "VIKING" para: Bosch - Metabo - Makita - Hitachi - De Walt**

**Refer:**  
4011-MPS

Semi-grueso 4,2 mm x 150 mm x 6 t.p.i.

**Madera**

Precio €  
**Blister 2 uds**  
6,68

**Refer:**  
4022-MPS

Grueso 8,5 mm x 230 mm x 3 t.p.i.

**Madera**

Precio €  
**Blister 2 uds**  
7,23

**Refer:**  
4020-MPS

Grueso 8,5 mm x 300 mm x 3 t.p.i.

**Madera**

Precio €  
**Blister 2 uds**  
8,48

**Refer:**  
4430-MPS

Fino 2,5 mm x 150 mm x 10 t.p.i.

**Metal**

Precio €  
**Blister 2 uds**  
7,68

**Refer:**  
4434-MPS

Fino 2,5 mm x 230 mm x 10 t.p.i.

**Metal**

Precio €  
**Blister 2 uds**  
10,65

**Refer:**  
4442VP-MPS

Fino 1,8-2,5 mm x 300 mm x 10-14 t.p.i.

**Metal**

Precio €  
**Blister 2 uds**  
16,54

**Hojas de Sierra de Sable "VIKING" para: Bosch - Metabo - Makita - Hitachi - De Walt**

<p><b>Refer:</b> 4037-MPS</p>	 <p>Made in Germany CV - Chrom Vanadium wood</p>	<p><b>Precio €</b> <b>Blister 2 uds</b> 6,78</p>
<p>Semi-groeso 4,2 mm x 230 mm x 6 t.p.i.</p>		<p>Pvc - Madera</p>

<p><b>Refer:</b> 4052-MPS</p>	 <p>Made in Germany CV - Chrom Vanadium wood-green</p>	<p><b>Precio €</b> <b>Blister 2 uds</b> 9,07</p>
<p>Groeso Irregular 5-6,5 mm x 240 mm x 4-5 t.p.i.</p>		<p>Madera Verde</p>

<p><b>Refer:</b> 4177-MPS</p>	 <p>MPS Sägen GmbH Coblenz-Prölsheim-Str. 3-5 D-54329 Prölsheimbach</p>	<p><b>Precio €</b> <b>Blister 1 und</b> 16,27</p>
<p>Semi-groeso 8,5 mm x 230 mm x 3 t.p.i.</p>		<p>Fibrocemento</p>



**Hojas de Sierra de Mano 300 mm**



FABRICADO EN EUROPA **TOMISA** BIMETAL STEEL M2 **HSS** VARIABLE TEETH 300 mm 20/24 TPI

<b>Refer:</b> 971220	<b>Descripción</b> Hoja Bi-metal 300 mm 20/24 Dientes por pulgada Dentado Alternativo	 100 HOJAS	<b>Precio €</b> 1,53
-------------------------	--	--	-------------------------





**VIKING SUPERCUT** HSS BI-METAL 20/24 tpi variable teeth MADE IN EU 51701604721203

<b>Refer:</b> 971210/SUP-VI	<b>VIKING</b> <b>Descripción</b> Hoja Bi-metal 300 mm 20/24 Dientes por pulgada Dentado Alternativo	 100 HOJAS	<b>Precio €</b> 1,72
--------------------------------	---	--	-------------------------





MADE IN EU **VIKING** ALLOY STEEL 12" 24T 51701604221246

<b>Refer:</b> 921210-VI	<b>VIKING</b> <b>Descripción</b> Hoja Acero al Carbono 300 mm 24 Dientes por pulgada	 100 HOJAS	<b>Precio €</b> 0,81
----------------------------	---	--	-------------------------



FABRICADO EN EUROPA **TOMISA** HIGH CARBON **HCS** STEEL FLEXIBLE 300 x 25 mm 24 TPI 814065011033204

<b>Refer:</b> 3010A332	 <b>Descripción</b> Hoja Acero al Carbono 300 mm 24 Dientes por pulgada	 50 HOJAS	<b>Precio €</b> 0,96
---------------------------	---	---	-------------------------



FABRICADO EN EUROPA **TOMISA** HIGH CARBON **HCS** STEEL FLEXIBLE WOOD - 8 TPI METAL - 24 TPI 814065011033710

<b>Refer:</b> 3010A337	  <b>Descripción</b> Hoja Acero al Carbono 300 mm. 24 - 8 Dientes por pulgada Doble corte <b>Madera y Metal</b>	 50 HOJAS	<b>Precio €</b> 1,03
---------------------------	--	---	-------------------------



**Cuchilla Multiherramienta Madera 20 mm**

**Refer:**  
3056H051

**Precio €**  
6,36





**Cuchilla Multiherramienta Madera 34 mm**

**Refer:**  
3056H050

**Precio €**  
6,52





**Cuchilla Multiherramienta Madera 87 mm**

**Refer:**  
3056H002

**Precio €**  
9,10





**Cuchilla Multiherramienta Azulejos 87 mm**

**Refer:**  
3056H001

**Precio €**  
6,52





**Cuchilla Multiherramienta Metal 34 mm**

**Refer:**  
3056H005

**Precio €**  
7,16



**Cuchilla Multiherramienta Raspador 52 mm**

**Refer:**  
3056H003

**Precio €**  
6,24



**Juego Cuchillas Multiherramienta 4 pzs**

**Refer:**  
3056H004

**Precio €**  
16,65



**Juego Cuchillas Multiherramienta 17 pzs**

**Refer:**  
3056H017

**Precio €**  
23,85





**Gafas de Policarbonato Incolora**

Refer:  
GL001C



12

Precio €  
2,07

Frente de una pieza incluyendo los oculares.  
Protecciones laterales incorporadas en las patillas.  
Espesor del ocular: 2.00 mm.  
Normas: EN166 - EN170



**Gafas de Policarbonato Ahumada**

Refer:  
GL001S



12

Precio €  
2,07

Frente de una pieza incluyendo los oculares.  
Protecciones laterales incorporadas en las patillas.  
Espesor del ocular: 2.00 mm.  
Normas: EN166 - EN172



**Gafas de Policarbonato Incolora**

Refer:  
EVALAB



10

Precio €  
1,80

Patillas perforadas para uso de cordón de sujección.  
Montura y patillas de policarbonato incoloro.  
Modelo sin ningun pieza metálica.  
Espesor del ocular: 2.00 mm.  
Normas: EN166 - EN170



**Gafas Antirayadura Regulable**

Refer:  
GL002C



12

Precio €  
2,37

Patillas perforadas para uso de cordón de sujección  
Ocular monobloque policarbonato con proteccion lateral.  
Montura de poliamida, color negro.  
Espesor del ocular: 2.00 mm.  
Normas: EN166 - EN170



**Gafas Antirayadura y Antivaho**

Refer:  
EVALIT



10

Precio €  
5,12

Ocular: espesor 2.00 mm. Policarbonato incoloro.  
Montura y patillas: policarbonato.  
Puente nasal: policarbonato.  
Tornillos: acero inoxidable.  
Normas: EN166 - EN170



**Gafas Policarbonato Patillas Tpr**

Refer:  
EVARED



10

Precio €  
5,17

Ocular: espesor 2.00 mm de una sola pieza en policarbonato incoloro.  
Puenta nasal: policarbonato integrado a la montura.  
Tornillos: acero inoxidable.  
Normas: EN166 - EN170

**Gafas con Montura Integral****Refer:**  
EVAMAS**Precio €**  
2,95

Con ventilación directa. Banda elástica ajustable.  
Montura PVC suave. Ocular de policarbonato incoloro.  
Espesor del ocular: 1.50 mm. Normas EN166

**Gafas Patillas Tpr Ahumadas****Refer:**  
EVAREDA**Precio €**  
5,55

Ocular: espesor 2.00 mm de una sola pieza en policarbonato incoloro. Normas EN166 y EN172  
Punta nasal: policarbonato integrado a la montura.

**Careta Protección Visor Plástico****Refer:**  
EVA805**Precio €**  
12,53

Banda desudadora.  
Espesor del visor: 1.00 mm.  
Dimensiones del visor: 305 x 190 mm. Normas EN166

**Careta Protección Rejilla Metálica****Refer:**  
EVA825**Precio €**  
14,36

Malla metálica en acero inoxidable.  
Banda desudadora.  
Dimensiones del visor: 305 x 195 mm. Normas EN1731

**Visor de recambio para careta****Refer:**  
ACC805LARG**Precio €**  
5,69

Fabricado en policarbonato incoloro.  
Fácil ajuste sobre el arnés.  
Dimensiones: 395 x 200 mm. Normas EN1731

**Rejilla de recambio para careta****Refer:**  
880F83-UPO**Precio €**  
6,86

Malla metálica en acero inoxidable.  
Fácil ajuste sobre el arnés.  
Dimensiones: 305 x 195 mm. Normas EN1731



**Mascarillas Autofiltrantes KN95**

Refer:  
KN95



30

Precio €  
0,91

*Diseño ergonómico.  
Clip nasal y elástico de ajuste.  
Transpirable e impermeable.  
Standard GB2626-2006 KN95*



**Mascarillas Antipolvo con Válvula**

Refer:  
1047-VO



15

FFP2

Precio €  
Caja  
17,35

*Clip nasal ajustable.  
Elásticos ajustables.  
Normativa EN149:2001+A1:2009*



Tallas  
L - XL - XXL

**Buzo Desechable Riesgo Menor**

Refer:  
PP-1B-...



50

CAT I

Precio €  
3,96

*Polipropileno 50 g/m2  
Cintura, puños y tobillos elásticos  
Cubierta con cremallera  
Trabajos de mantenimiento y bricolaje*



Tallas  
L - XL - XXL

**Buzo Desechable Riesgo Químico**

Refer:  
CV001-...



50

CAT III  
5B + 6B

Precio €  
4,99

*Polipropileno 65 g/m2  
Cintura, puños y tobillos elásticos  
Cubierta con cremallera  
Trabajos químicos nocivos*



**Protector de Oídos Bricolage**

**Refer:** CASBRUI **Peso:** 145 grs **Precio €** 5,69  
**Norma EN352-1**  
 SNR 29dB (H:33 dB M:27dB L:17 dB).



**Protector de Oídos Profesional**

**Refer:** HG106J **Peso:** 168 grs **Precio €** 8,41  
**Norma EN352-1**  
 SNR: 27,6dB (H:30,4 dB M:24,9 dB L:17,7 dB).



**Protector de Oídos ELECTRONICO "CE"**

**Refer:** 805/E-UPO **Precio €** 39,12  
 Aisla ruidos > 85 Db.  
 Funciona con 2 pilas AA (no incluidas).



**Tapón Auditivo Pu sin cordón**

**Refer:** HGB030 **Precio €** 9,77  
**Caja**  
 50

SNR 34dB (H: 33 dB M: 31 dB L: 28 dB).  
 Diámetro 6-12 mm. Norma EN352-2



**Gafas de Policarbonato Amarillas**

**Refer:** GL001Y **Precio €** 2,07  
 12

Fronte de una pieza incluyendo los oculares.  
 Protecciones laterales incorporadas en las patillas.  
 Espesor del ocular: 2.00 mm.  
 Normas: EN166 - EN170



**Tapón Auditivo Pu con cordón**

**Refer:** HGB030C **Precio €** 19,49  
**Caja**  
 50

SNR 34dB (H: 33 dB M: 31 dB L: 28 dB).  
 Diámetro 6-12 mm. Norma EN352-2



EN 388:2016  
3131X

CE

**Guante Poliester Revestido en PU gris**

Refer: 2803/...-TOM **Precio €** 0,95

- \* Agricultura
- \* Almacenaje
- \* Construcción

6 - 7 - 8 - 9 - 10 12 240



EN 388:2016  
3131X

CE

**Guante Poliester Revestido en PU negro**

Refer: 2903/...-TOM **Precio €** 0,95

- \* Agricultura
- \* Almacenaje
- \* Construcción

7 - 8 - 9 - 10 12 240



**Guante de Nitrilo Verde Reforzado**

Refer: 81600/...-MAT **Precio €** 2,46

- \* Agroquímicos
- \* Bricolage

EN 388: 2016 EN ISO 374-1:2016 / Tipo A EN ISO 374-5:2016

4101X JKLOPT VIRUS

Flocado Espesor: 0,38 mm Largo: 315 mm

8 - 9 - 10 12 144

CE CAT - III



EN 388:2016  
3141X

CE

**Guante Algodón y Látex Rugoso**

Refer: 1201/...-TOM **Precio €** 1,73

- \* Agricultura
- \* Jardinería
- \* Construcción

8 - 9 - 10 12 120



EN 388:2016  
3121X

CE

**Guante Poliester Revestido en Nitrilo**

Refer: 2002/...-TOM      Precio € 0,95

- \* Agricultura
- \* Almacenaje
- \* Construcción

6 - 7 - 8 - 9 - 10      12      120



EN 388 4244X      EN 407 41324X

CE

**Guante de Soldador Crupón Vacuno**

Refer: 81500/09-TOM      Precio € 5,35

- \* Soldadura
- \* Calderería
- \* Hornos

350 mm

9      TIPO A      12      60



EN 388:2016  
2122X

CE

**Guante Piel y Algodón con Velcro**

Refer: 81400/...-TOM      Precio € 3,90  
81401/...-TOM      con colgador de cartón      4,05

- \* Agricultura
- \* Almacenaje
- \* Construcción

7 - 8 - 9 - 10      12      120



EN 388:2016  
4144X

CE

**Guante Limonero Piel y Serraje**

Refer: 81250/...-TOM      Precio € 4,90  
81251/...-TOM      con colgador de cartón      5,05

- \* Agricultura
- \* Soldadura

7 - 8 - 9 - 10      12      60



CE

EN 388:2016



3121X

**Guante Piel Flor Vacuno Blanco**

Refer:		Precio €
81200/...-TOM	sin colgador de cartón	3,70
81201/...C-TOM	con colgador de cartón	3,90

- \* Construcción
- \* Almacenaje
- \* Automoción



7 - 8 - 9 - 10 - 11



12



120



CE

EN 388:2016



3121X

**Guante Piel Flor Eco Blanco**

Refer:		Precio €
81300/...-TOM	sin colgador de cartón	3,14
81301/...C-TOM	con colgador de cartón	3,25

- \* Construcción
- \* Almacenaje
- \* Automoción



7 - 8 - 9 - 10 - 11



12



120



**Guante de Nitrilo Reforzado Extra Largo**

Refer:	Precio €
81690/09-IS	7,56

- \* Procesos Químicos
- \* Refinerías
- \* Laboratorio

CE

CAT - III

CE 0321



Flocado Espesor: 0,58 mm Largo: 450 mm



9



12



120



EN 388:2016



4244X

CE

**Guante Serraje Crupón Vacuno y Lona**

Refer:	Precio €
81208/...-TOM	2,95

- \* Construcción
- \* Almacenaje
- \* Ferralla



9 - 10



12



120



CE

**Guante Desechable Nitrilo Azul 3,5 Gr**

**Refer:** 81800/...-MAT **Precio €** 5,36  
 \* Puño con reborde  
 \* Sin polvo  
 \* Ambidiestros

ISO 374-1:2016/A1:2018 / Tipo B

ISO 374-5:2016



J K T



VIRUS



S - M - L - XL



100



1000



CE

**Guante Desechable Nitrilo Negro 5,0 Gr**

**Refer:** 81850/...-MAT **Precio €** 7,18  
 \* Puño con reborde  
 \* Sin polvo  
 \* Ambidiestros

ISO 374-1:2016/A1:2018 / Tipo B

ISO 374-5:2016



J K T



VIRUS



S - M - L - XL



100



1000



CE

**Guante Diamantado Nitrilo Naranja 8,5 Gr**

**Refer:** 81900/...-MAT **Precio €** 8,09  
 \* Puño con reborde  
 \* Sin polvo  
 \* Ambidiestros

ISO 374-1:2016/A1:2018 / Tipo B

ISO 374-5:2016



J K T



VIRUS



M - L - XL



50



500



**Guante de Latex Bicolor 100 % Reforzado**

**Refer:** 81120/...-MAT **Precio €** 1,52  
 \* Albañilería  
 \* Bricolage  
 \* Agricultura

CE  
 CAT - III



Flocado

Espesor: 0,45 mm

Largo: 300 mm



8 - 9 - 10



12



120



**Aceitera de Precisión Gota a Gota**

**Refer:**  
3987-PR



**Precio €**  
15,54

Cuerpo de Aluminio



**Aceitera Metálica con latiguillo flexible**

**Refer:**  
326130-PR

Depósito 300 ml

**Precio €**  
4,50



**Densímetro de Cristal para líquidos**

**Refer:**  
3740-PR



**Precio €**  
5,51

Para medir los niveles de ácido de las baterías



**Martillo Ebanista con Mango de Madera**

<b>Refer:</b>	g	mm	<b>Precio €</b>
57/100-TOM	100	16	3,28
57/200-TOM	200	18	3,37
57/250-TOM	250	20	4,27
57/300-TOM	300	22	4,76
57/400-TOM	400	25	5,42
57/500-TOM	500	28	6,44



**Batidores de Pintura Hexagonales**

Refer:	Ø	↔	Precio €
1115/1-TOM	60	400	3,10
1115/2-TOM	85	400	3,49
1115/3-TOM	100	600	5,15



**Mezcladores de Mortero Rosca M-14**

Refer:	Ø	↔	Precio €
1116/1-TOM	100	600	11,25
1116/2-TOM	120	600	11,95
1116/3-TOM	140	600	13,25
1116/4-TOM	160	600	14,10

Ideales para remover mortero, yeso y cemento cola.  
Fabricados en acero cincado.  
Enganche mediante rosca M-14.



**Mezcladores de Mortero Sds Plus**

Refer:	Ø	↔	Precio €
1117/1-TOM	100	600	8,50
1117/2-TOM	120	600	9,25

Ideales para remover mortero, yeso y cemento cola.  
Fabricados en acero cincado.  
Enganche mediante sistema Sds Plus.



**Desatascador de Ventosa**

Refer:	Ø	Precio €
55505-YT	65 - 155 mm	13,93



**Desatascadores de Muelle**

Refer:	↔	Precio €
10050-TOM	1,5 mts x 6 mm	3,58
10051-TOM	3 mts x 6 mm	6,85
10052-TOM	4,5 mts x 6 mm	9,79
10055-TOM	6 mts x 8 mm	18,50
10056-TOM	8 mts x 8 mm	20,36



**Grapadora Manual Cromada**

**Refer:** **3041E905** Admite grapas de 4 a 14mm **Precio €** 10,20  
Regulador de presión



Compatible con: ESCO 530 - NOVUS 53



**Grapadora Manual de Plástico**

**Refer:** **3171000-YT** Admite grapas de 4 a 8 mm **Precio €** 5,91



Compatible con: ESCO 530 - NOVUS 53



**Grapadora de Golpe**

**Refer:** **334-UPO** **Precio €** 22,10

Admite grapas de 6 a 14 mm



**Grapas para grapadora manual, cajas 1000 uds.**

<b>Refer:</b>	<b>←→</b>	<b>Precio €</b>
338/6-PR	6 mm x 11,3 x 0,7	0,98
338/8-PR	8 mm x 11,3 x 0,7	1,03
338/10-PR	10 mm x 11,3 x 0,7	1,06
338/12-PR	12 mm x 11,3 x 0,7	1,58
338/14-PR	14 mm x 11,3 x 0,7	1,46

Compatibles con: ESCO 530 - NOVUS 53



**Marcadores permanentes 3 pzs.**

**Refer:** **699-PR** Colores: azul, rojo y negro **Precio €** 3,47

Resistente al agua

Blíster



24

**Cintas de Persianas en rollos y bobinas**

Refer:		↔		Precio €
67MINI/6-CL	14 mm x 6 mts		Mini	1,78
67107GP/6-CL	20 mm x 6 mts		Eco	1,85
67150GC/6-CL	20 mm x 6 mts		Extra	2,51
67MINI/50-CL	14 mm x 50 mts		Mini	12,04
67107GP/50-CL	20 mm x 50 mts		Eco	12,61
67150GC/50-CL	20 mm x 50 mts		Extra	17,87

**Trinquetes de Nylon con Hebilla, 2 pzs.**

Refer:		↔	Precio €
3097X183-TOP	2,5 mts x 25 mm		7,53
3097X184-TOP	5 mts x 25 mm		10,37

  
12

**Trinquetes de Nylon con carraca**

Refer:		Precio €
3755/1-PR	SIN ganchos Cinta de 5 mts x 25 mm ancho	6,94
3755/2-PR	CON 2 ganchos Cinta de 5 mts x 25 mm ancho	7,20

  
12

**Cinturón serraje Porta-Herramientas**

Refer:	Precio €
3079R401	13,58

Múltiples bolsillos

En Serraje de cerdo



**Rascavidrios de Plástico con 2 Hojas**

**Refer:**  
3018B550-TOP

**Precio €**  
0,92

Hoja No recambiable tipo trapecio

**Rascavidrios de Plástico Reforzado**

**Refer:**  
815-PR

**Precio €**  
1,34

Hoja recambiable tipo trapecio



**Juego de Fresas, 6 pzs.**

**Refer:**  
444-TOM

Aluminio - Madera - Plástico

**Precio €**  
18,99



**Juego Piedras de esmeril, 5 pzs.**

**Refer:**  
3060H005

**Precio €**  
3,33



**Juego de Piedras, 5 pzs.**

**Refer:**  
60H007

Madera - Plástico

**Precio €**  
8,29



**Juego de Minilimas, 6 pzs.**

**Refer:**  
62-PR

↔  
150

**Precio €**  
6,19



**Tijera de Recolección 190 mm**

<b>Refer:</b> 318816-YT	<b>Precio €</b> 8,62
----------------------------	-------------------------



**Tijera de Vendimia 180 mm**

<b>Refer:</b> 318815-YT	<b>Precio €</b> 8,62
----------------------------	-------------------------



**Tijera de Poda 215 mm**

<b>Refer:</b> 3199203-YT	<b>Precio €</b> 8,93
-----------------------------	-------------------------

Ø Máximo de corte: 15 mm



**Tijera Cortachapa Recta con Muelle**

<b>Refer:</b> 387-TOM	 250	<b>Precio €</b> 7,36
--------------------------	--	-------------------------

Mango Ergonómico



**Pistola de Silicona Bricolage**

**Refer:**  
330/2-TOM

**Precio €**  
2,94



24

Para cartuchos de silicona de poca densidad

**Pistola de Silicona Skeleto**

**Refer:**  
331-TOM

**Precio €**  
5,05



24

Incluye limpiador de boquilla

**Pistola de Silicona Dentada**

**Refer:**  
330-TOM

**Precio €**  
4,90



24

Incluye limpiador de boquilla y cuchilla

**Pistola de Silicona Profesional**

**Refer:**  
333-TOM

**Precio €**  
9,48



12

**Pistola de Silicona Reforzada**

**Refer:**  
333/2-TOM

**Precio €**  
15,65

  
12

Especial para masillas y resinas

**Pistola de Triple Émbolo**

**Refer:**  
335/2-TOM

**Precio €**  
16,84

  
12

Para cartuchos químicos de 410 ml

**Pistola Aluminio Cerrada**

**Refer:**  
332/310-TOM  
332/600-TOM

**Precio €**  
10,32  
12,65

  
12

Para usos con cartuchos y bolsas de mortero  
Incluye boquilla y tapón retenedor para líquidos

**Boma Sopladora Agujeros**

**Refer:**  
CP10-GB

**Precio €**  
10,95

Cuerpo de plástico, y cánula giratoria.

Ideal para extraer polvo sobrante tras el taladrado.

	<b>Pistola Espuma Poliuretano Basic</b>	<b>Refer:</b>	<b>Precio €</b>
	<b>338-TOM</b>	 20	9,75
<p>Aumenta el rendimiento de la espuma hasta un 30%.                  Disminuye las post-expansión hasta un 60%.                  Mantiene el grosor de la espuma estable durante el proceso de aplicación. Más fácil de limpiar.</p>			





	<b>Pistola Espuma Poliuretano Semi Profesional</b>	<b>Refer:</b>	<b>Precio €</b>
	<b>336-TOM</b>	 20	14,91
<p>Aumenta el rendimiento de la espuma hasta un 30%.                  Disminuye las post-expansión hasta un 60%.                  Mantiene el grosor de la espuma estable durante el proceso de aplicación. Más fácil de limpiar.</p> <p style="text-align: center;"><b>* Válvula teflonada</b></p>			

	<b>Pistola Espuma Poliuretano Profesional</b>	<b>Refer:</b>	<b>Precio €</b>
	<b>337-TOM</b>	 20	23,26
<p>Aumenta el rendimiento de la espuma hasta un 30%.                  Disminuye las post-expansión hasta un 60%.                  Mantiene el grosor de la espuma estable durante el proceso de aplicación. Más fácil de limpiar.</p> <p style="text-align: center;"><b>* Boquilla y válvula teflonada</b></p>			

		Espátulas mango de madera		
		Refer:	↔	📦
68/40-PR	40	12	1,13	
68/50-PR	50	12	1,22	
68/60-PR	60	12	1,33	
68/80-PR	80	12	1,56	
68/100-PR	100	12	1,76	

		Espátulas Inoxidables mango Bi-material		
		Refer:	↔	📦
3018B604-TOP	40	12	2,47	
3018B606-TOP	63	12	3,00	
3018B607-TOP	75	12	3,09	
3018B610-TOP	100	12	3,56	
3018B612-TOP	125	12	4,28	

			
Espátulas de carroceros Metálicas, 4 pzs		Espátulas de carroceros Plásticas, 4 pzs	
Refer:	Precio €	Refer:	Precio €
390-TOM	De hojas muy flexibles 2,48	390A-PF	De hojas muy flexibles 1,45
			
Espátulas de carroceros Inoxidables, 4 pzs		Espátula de Plástico Dentada	
Refer:	Precio €	Refer:	Precio €
391-TOM	De hojas muy flexibles 4,28	390/B-PR	↔ 90 x 130 mm 0,59



**Embudo de Plástico Flexible**

<b>Refer:</b> 620151	<b>Precio €</b> 2,29
-------------------------	-------------------------

Diámetro Boca: 140 mm  
Longitud Flexo: 380 mm



**Llave para Amoladora Universal**

<b>Refer:</b> 3066H320		<b>Precio €</b> 6,41
---------------------------	---	-------------------------

Para Radiales de 115 mm y 230 mm



**Llave para Amoladora Regulable**

<b>Refer:</b> 4490-TOM		<b>Precio €</b> 8,20
---------------------------	---	-------------------------

Para Radiales de 115 mm y 230 mm



**Llave para Lavabo Articulada**

<b>Refer:</b> 191-TOM		<b>Precio €</b> 13,95
--------------------------	---	--------------------------

Rango de apertura: 15 - 32 mm



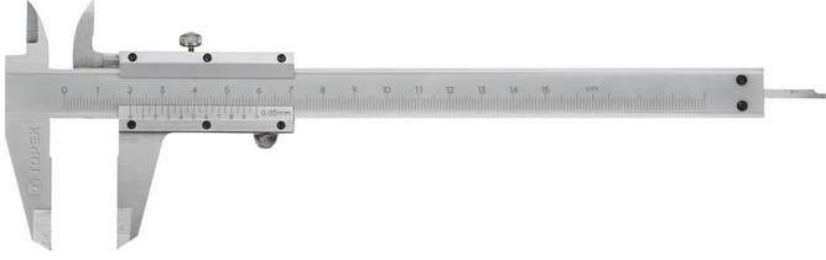

**Calibre Digital Inox**

<b>Refer:</b> 1346-PR		Inoxidable	En Estuche de Plástico	<b>Precio €</b> 27,10
	150			





**Calibre Metálico**

<b>Refer:</b> 1345-PR		Inoxidable	En Funda de Cuero	<b>Precio €</b> 20,89
580804	150	Acero	En Estuche de Plástico	16,06



**Calibre de Plástico**

<b>Refer:</b> 134-PR				<b>Precio €</b> 2,10
	150			



**Transportador de Angulos con Regla**

<b>Refer:</b> 580718		Inoxidable	180°	<b>Precio €</b> 7,09
	150			

**Niveles de Aluminio, Profesionales**

Refer:	↔		Precio €
3029C602-TOP	600	3	15,01
3029C603-TOP	800	3	17,58
3029C604-TOP	1000	3	21,45

**Niveles de Aluminio, Bricolage**

Refer:	↔		Precio €
3029C501-TOP	400	2	6,83
3029C502-TOP	600	2	8,44
3029C503-TOP	800	2	12,28

**Nivel Torpedo Magnético**

Refer:	↔		Precio €
3029C894	230	3	2,81

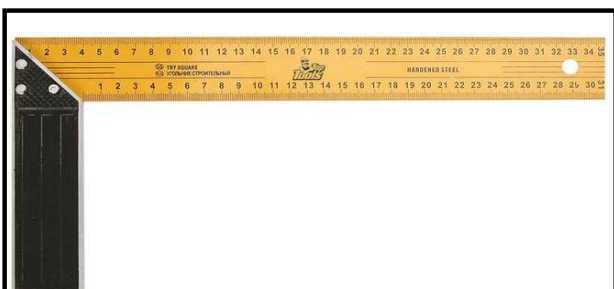
**Escuadra para Carpintero Bricolage**

Refer:	↔		Precio €
3030C335-TOP	350	6	2,85

**Escuadra para Carpintero Profesional**

Refer:	↔		Precio €
580713	300	6	7,22
580714	400	6	8,66



**Nivel Angular Reglable**

Refer: 3030C321-TOP 500 2 0-270° Precio € 31,20



**Nivel Plegable Magnético**

Refer: 3029C897-TOP Precio € 4,89

3



**Flexómetros con Freno y Correa**

Refer:			Precio €
3027C303-TOP	3 M x 16 mm	10	3,51
3027C305-TOP	5 M x 19 mm	10	5,55
3027C308-TOP	8 M x 25 mm	6	9,40



**Flexómetros con Freno, Correa e Imán**

Refer:			Precio €
3027C343-TOP	3 M x 19 mm	12	5,97
3027C345-TOP	5 M x 25 mm	12	8,34



**Cinta Métrica Metálica con Carcasa**

Refer: 3028C412-TOP 20 M x 12,5 mm Precio € 12,32



**Cinta Métrica de Nylon Abierta**

Refer: 3028C550-TOP 50 M x 13 mm Precio € 17,51

**Llave de Sifón Forrada**

Refer:	↔	📦	Precio €
190-PR	230	5	7,80

Bocas Plásticas.

Diámetro máximo apertura: 80 mm

**Llaves Stillson Profesionales**

Refer:	↔	↔	Precio €
10300-TOM	300	12	14,65
10350-TOM	350	14	17,95
10450-TOM	450	18	25,45
10600-TOM	600	24	37,90
600816	900	36	57,36
600817	1200	48	93,81

  
6

**Llaves Stillson de Aluminio**

Refer:	↔	↔	Precio €
20250-TOM	250	10	18,53
20300-TOM	300	12	23,18
20350-TOM	350	14	29,71
20450-TOM	450	18	44,78
20600-TOM	600	24	69,65
20900-TOM	900	36	139,50
20120-TOM	1200	48	232,54

  
6

**Llave para Contadores de 4 Usos**

Refer:	Precio €
4424667-TOM	4,56

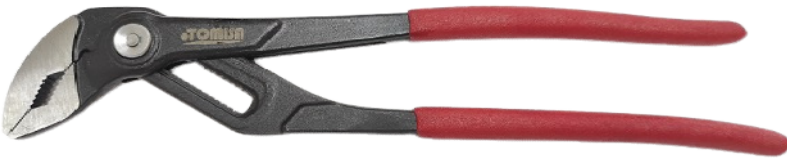

  
20



**Tenaza Pico Loro Botón**

Refer:	↔	📦	Precio €
273/240-TOM	250	10	19,52
273/300-TOM	300	6	24,22

Cromo Vanadio. DIN ISO 8976



**Tenaza Pico Loro Forrada**

Refer:	↔	📦	Precio €
272CV/175-PR	175	10	7,06
272CV/240-PR	240	10	8,31
272CV/300-PR	300	6	13,51
272CV/400-PR	400	5	43,35

Cromo Vanadio. DIN ISO 8976 C



**Llave de Cadena Profesional**

Refer:	↔	📦	Precio €
1170300-TOM	410	6	31,70
1170560-TOM	560	6	34,11

Disponible en 2 largos de cadena.



**Llave de Cadena Gran Carga**

Refer:	↔	📦	Precio €
1170900-TOM	900	1	86,30

Longitud de cadena: 747 mm

Bocas forjadas dentadas y eje en acero



**Llave de Cinta Profesional**

Refer:	↔	📦	Precio €
258-TOM	1000	5	33,88
258/B-TOM	Cinta Repuesto		6,50

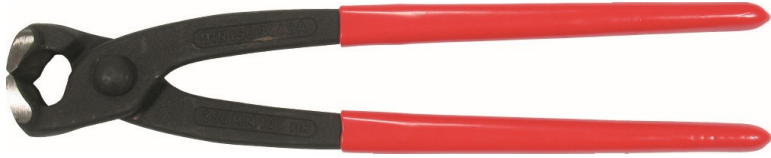

**Tenaza Rusa Forrada**

Refer:	↔		Precio €
278/220-PR	220	10	4,94
278/250-PR	250	10	5,38
278/280-PR	280	10	6,37

Cromo Vanadio DIN ISO 9242 A



**Corta-Cables de acero Trenzado**

Refer:	↔		Precio €
1250-PR	190		19,74

Mangos Plásticos.

Corte Máximo: 5 mm.

Con muelle de apertura y palanca de cierre.



**Alicate de Corte Frontal Profesional**

Refer:	↔	Precio €
831236/160-PAD	160	29,23





**Alicate para Cortar Azulejos**

Refer:	↔	Precio €
3016B440-TOP	200	7,32





**Alicate Universal Aislado Profesional**

**Refer:** 1185/180VDE-TOM ↔ 📦 12 **Precio €** 17,41

Acero al Cr-Mo ⚡ 1000V 🏠 🔄 🔌

Acabado Satinado



**Pelacables Manual Aislado Profesional**

**Refer:** 1172/160VDE-TOM ↔ 📦 12 **Precio €** 16,55

Acero al Cr-Mo ⚡ 1000V 🏠 🔄 🔌

Acabado Satinado



**Alicate Cortabulones Profesional**

**Refer:** 1170200 ↔ 📦 6 **Precio €** 14,36

Acero al Cr-V 🔌

Corte: Ø 3 mm Alambre blando  
Ø 5 mm Alambre duro



**Tijera de Electricista Mango Forrado**

**Refer:** 660625 ↔ 📦 6 **Precio €** 6,78

Acero al Cr-V 🔌

Dureza: Hrc 52-56

**Alicates para Bujías "ELORA"**



Refer:	Descripción	↔	Precio €
464/200AI-ELO	Pico Curvo	200	23,19



Refer:	Descripción	↔	Precio €
465/230AI-ELO	Pico Recto	230	35,35
465/300AI-ELO	Pico Recto	300	40,25

**Alicate para Válvulas "ELORA"**



Refer:	↔	Precio €
268-ELO	275	42,56

Alicate válido para VW y AUDI

**Alicate para Frenos de Mano "ELORA"**



Refer:	↔	Precio €
296-PR	230	31,61

Alicate para montar y desmontar los cables de los frenos de mano 2.5 mm.

**Alicates para Anillos de Segmentos**



Refer:	Precio €
235/60-ELO	32,92

Para anillos entre 60 y 160 mm.  
Bocas en Acero C-45.



Refer:	Precio €
235/30-ELO	22,88

Para anillos entre 30 y 60 mm.  
Bocas en Acero C-45.  
Con tornillo de fijación para evitar un alargamiento excesivo.



**Mordaza Grip Universal**

Refer:	↔	Precio €
287/180-TOM	180	7,73
287/250-TOM	250	8,79

 Calidad Bricolaje



**Mordaza Grip Universal Forrada**

Refer:	↔	Precio €
3032D856-TOP	250	14,97

 Cr V  
 Calidad Semi-Profesional



**Mordaza de Mesa Profesional**

Refer:	↔	Precio €
523/300-ELO	285	34,50

Para sujeción de piezas sobre una mesa.  
 Atornillable a un lugar fijo.  
 Niquelada



**Mordaza Grip Boca de Cobre**

Refer:	↔	Precio €
522/235-ELO	235	32,58

Bocas planas (fija y oscilante). Apertura 0 - 40 mm  
 Superior en cobre e inferior en CrV.  
 Propia para trabajos de soldadura.





**Mordaza Grip Basculante**

<b>Refer:</b>	↔	<b>Precio €</b>
521/290-ELO	290	39,18

Capacidad de 0-70 mm



**Mordaza Grip Bocas Oscilantes**

<b>Refer:</b>	↔	<b>Precio €</b>
506/50-ELO	255	24,37

Bocas paralelas oscilantes de 80 mm de ancho.  
Niquelada.



**Mordaza para Chapistas**

<b>Refer:</b>	↔	<b>Precio €</b>
514/210-ELO	210	32,62



**Mordaza para Chapistas**

<b>Refer:</b>	↔	<b>Precio €</b>
517/230-ELO	230	33,69



	<b>Cuter de Plástico</b>		 9 mm	 24	<b>Precio €</b> 0,84
	Refer:	212-PR			
	<b>Cuter de Plástico con Guía Metálica</b>		 9 mm	 24	<b>Precio €</b> 1,31
	Refer:	570301			

	<b>Cuter de Plástico</b>		 18 mm	 40	<b>Precio €</b> 0,95
	Refer:	211-PR			
	<b>Cuter de Plástico y Metal</b>		 18 mm	 40	<b>Precio €</b> 1,14
	Refer:	570306			
	<b>Cuter de Plástico y Goma</b>		 18 mm	 24	<b>Precio €</b> 3,06
	Refer:	570312			
	Incluye 3 cuchillas				

**Hojas de Recambio para Cuter**

**Refer:**  **Precio €**  
 570341 9 mm 1,20

Hoja tronzeable

Blíster: 10 pzs.



24



**Refer:**  **Precio €**  
 570343 18 mm 1,47

Hoja tronzeable

Blíster: 10 pzs.



40



**Refer:**  **Precio €**  
 570349 25 mm 4,24

Hoja tronzeable

Blíster: 10 pzs.



12

**Hojas de Recambio para Rascador**

**Refer:**  **Precio €**  
 620219 100 mm 1,80

Blíster: 10 pzs.



12

**Hojas de Recambio tipo trapecio**

**Refer:** **Precio €**  
 570345 2 orificios 1,43

Blíster: 10 pzs.



**Refer:** **Precio €**  
 3017B2H5-TOP 2 orificios y ganchos 2,98

Blíster: 5 pzs.



**Cortatubos y Cuchillas de Recambio**
**Refer:**
**3020022-TOM**

Modelo Mini

**3030032-TOM**

Modelo Grande con rascador

**3034D052-TOP**

Recambios 6 uds de 18 x 3 mm

mm

3 a 22

3 a 32

**Precio €**

6,75

11,79

9,07

**Cizallas para corte de PVC**
**Refer:**
**74/42-PR**

mm

42

**Precio €**

25,98

**74/42B-TOM**

Hoja Recambio 42 mm

3,98

**Cortavarillas Profesional**
**Refer:**
**30350-TOM**

14" - 350 mm

**Precio €**

18,13

**30450-TOM**

18" - 450 mm

24,25

**30600-TOM**

24" - 600 mm

33,25

**30750-TOM**

30" - 750 mm

41,62

**30900-TOM**

36" - 900 mm

57,55

Acero Cr V

Dureza HRC40

**Recambio Cuchilla Cortavarillas**
**Refer:**
**30350B-TOM**

14" - 350 mm

**Precio €**

9,90

**30450B-TOM**

18" - 450 mm

11,83

**30600B-TOM**

24" - 600 mm

19,95

**30750B-TOM**

30" - 750 mm

22,72

**30900B-TOM**

36" - 900 mm

28,07

Acero Cr V



Dureza HRC40





**Cinceles de Albañil**



Refer:	DIN 7254	↔	📦	CR V	Precio €
4000/200-PAD	200		10	Mango Plano	10,50
4000/250-PAD	250		10	Mango Plano	11,85
4000/300-PAD	300		10	Mango Plano	14,46
4000/400-PAD	400		10	Mango Plano	18,75



**Cinceles de Electricista**

Refer:	↔	📦	CR V	Precio €
365/200-PAD	200 x 8 x 10	10	Mango Cuadrado	8,49
365/250-PAD	250 x 8 x 10	10	Mango Cuadrado	8,94



**Llave Carraca Andamio**

Refer:	Precio €
1244/1922-WH	33,38

 mm  
19x22



**Mango de Plástico con Hoja Doble**

Refer: 3010A212-TOP

Hoja con doble diente: Madera - Metal

**Precio €**  
2,74



**Cuñas para Azulejos Albañil**

Refer: 04700



100



23 mm

**Precio €**  
0,85



**Juego Cuchillas Precisión, 16 pzs**

Refer: 17B716

Cuchillas tipo bisturí

**Precio €**  
6,45



**Cajetín de Corte a 22.5°, 45° y 90°**

Refer: 3010A844-TOP



mm

295 La x 80 An x 70 Al

**Precio €**  
7,14



**Cajetín de Corte a 22.5°, 45° y 90°**

Refer: 3010A846-TOP



mm

320 La x 120 An x 75 Al

**Precio €**  
10,82



  
 12  
 Dientes templados

**Serrucho de Punta Fina Mango curvo**

<b>Refer:</b> 631215	Hoja de 1.2 mm x 150 mm en acero al carbono Mango en PP y TPR bi-color. Dientes alternativos.	 150	<b>Precio €</b> 6,73
-------------------------	---	--	-------------------------



  
 12  
 Dientes templados

**Serrucho de Punta Fina Hoja Larga**

<b>Refer:</b> 631227	Hoja de 1.0 mm (T) x 270 mm en acero al carbono. Mango en ABS y TPR. Dientes alternativos.	 270	<b>Precio €</b> 6,68
-------------------------	--	--	-------------------------



  
 10  
 Dientes templados

**Serruchos de Carpintero con mango Bi-material**

<b>Refer:</b> 631016		 400	<b>Precio €</b> 9,53
631018		450	9,80



  
 10  
 Dientes templados

**Serruchos de Costilla con mango Bi-material**

<b>Refer:</b> 3010A703-TOP		 300	<b>Precio €</b> 9,50
3010A706-TOP		350	11,65



Rasqueta para Juntas		
Refer:	↔	Precio €
3016B471-TOP	210	6,06

Recambios para Rasqueta		
Refer:		Precio €
3016B471/1-TOP	2 uds	2,83



**Arco de sierra Mango Engomado Profesional**

Refer: 27322-YT

300

6

Precio € 14,61



**Arco de sierra tubular Mango Aluminio**

Refer: 3010A225-TOP

300

6

Precio € 6,83



**Arco de sierra tubular Mango Plástico**

Refer: 610702

300

10

Precio € 4,22



**Miniarco de sierra Mango de Plástico**

<b>Refer:</b> 686-TOM	 150	 25	<b>Precio €</b> 1,85
--------------------------	--	---	-------------------------



**Miniarco de sierra Mango de Plástico**

<b>Refer:</b> 610701	 150	 10	<b>Precio €</b> 2,95
-------------------------	--	---	-------------------------

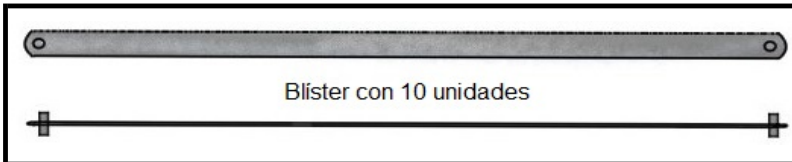

**Hojas de sierra Mini de 150 mm**

<b>Refer:</b> 688/150-PR	 150	 12	<b>Precio €</b> 2,15
-----------------------------	--	---	-------------------------

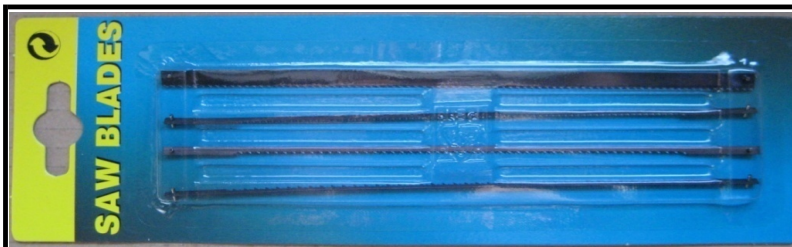

**Hojas de Recambio Marquetería**

<b>Refer:</b> YU-4330H4-UPO	 165	 12	<b>Precio €</b> 1,90
--------------------------------	--	---	-------------------------

Blister con 4 hojas

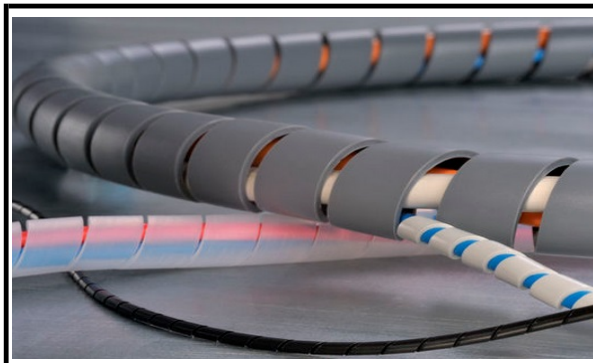
**Espiral Organizadora de Cables**

Refer:	Ø	Mts. x	Color	€ Rollo
870912/N-TOM	9-12 mm	10	Negro	8,45
870912/B-TOM	9-12 mm	10	Transparente	8,45
871519/N-TOM	15-19 mm	10	Negro	12,10
871519/B-TOM	15-19 mm	10	Transparente	12,10
872024/N-TOM	20-24 mm	10	Negro	15,99
872024/B-TOM	20-24 mm	10	Transparente	15,99

**Funda Termorretractil Negra para unir y aislar cables**

Refer:	Ø	Mts. x	€ Bolsa
27TRM24N-LER	2,4 mm	10 tiras x 1 m	2,35
27TRM34N-LER	3,4 mm	10 tiras x 1 m	2,65
27TRM49N-LER	4,9 mm	10 tiras x 1 m	3,39
27TRM64N-LER	6,4 mm	10 tiras x 1 m	4,03
27TRM95N-LER	9,4 mm	10 tiras x 1 m	4,95
27TRM125N-LER	12,5 mm	10 tiras x 1 m	7,25
27TRM200N-LER	20,0 mm	10 tiras x 1 m	14,11

Ratio de Contracción: 2:1

**Estuche Funda Termorretractil 520 pzs**

 Refer:  
27TRM-TOM

 Precio €  
8,45

Ratio de Contracción: 2:1

Longitud piezas: 45 mm

5 colores: negro, rojo, verde, azul y amarillo.

Ideal para unión y aislamiento de cables eléctricos.







**Grapa con Taco para Manguera Eléctrica**

Refer:	Ø		€ Caja
500G-NL	3-13 mm	100	10,32



**Grapas para Cables eléctricos con punta de acero**

Refer:	Tipo de cable		€ Caja
63000/04-VO	Manguera de 4 mm	100	2,62
63010/05-VO	Manguera de 5 mm	100	2,62
63020/06-VO	Manguera de 6 mm	100	2,65
63030/07-VO	Manguera de 7 mm	100	2,87
63040/08-VO	Manguera de 8 mm	100	3,16
63050/10-VO	Manguera de 10 mm	100	4,55
63060/12-VO	Manguera de 12 mm	100	5,35
63120/06-VO	Paralelo de 6 mm	100	2,72
63110/08-VO	Paralelo de 8 mm	100	3,43



**Clavija de Goma**

Refer: 86147-REV

Según Norma DIN 49441

Según Normas VDE, OVE e IP 44

Flexible y segura

Precio € 2,80



20



**Base Aerea de Goma**

Refer: 86151-REV

Según Norma DIN 49441

Según Normas VDE, OVE e IP 20

Flexible y segura

Precio € 4,09



20

**Clavijas con Toma-Tierra**

 En policarbonato  
 Según normas VDE, OVE y otras.



Refer:	Modelo	Color		Precio €
86110-REV	Toma frontal con cuello	Negro	50	1,20



Refer:	Modelo	Color		Precio €
86109-REV	Toma lateral	Negro	50	1,26

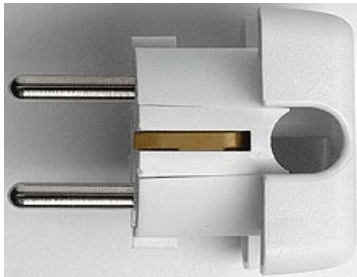

Refer:	Modelo	Color		Precio €
86101-REV	Toma frontal con cuello	Blanco	50	1,15



Refer:	Modelo	Color		Precio €
86111-REV	Toma lateral	Blanco	40	1,70

**Extra Plana**

**Base Aerea Negra con Toma-Tierra**
**Base Aerea Blanca con Toma-Tierra**

Refer:			Precio €
86099-REV	Sin Cuello	25	1,63
86121-REV	Con Cuello	25	1,71

Refer:			Precio €
86120-REV		25	1,71

 En policarbonato  
 Según normas VDE, OVE y otras.

 En policarbonato  
 Según normas VDE, OVE y otras.

Negras

Blancas



**Estuche de terminales, 200 uds.**

**Refer:** 3160-PR **Precio €** 18,79

Surtido de 18 modelos diferentes

En estuche de plástico



**Alicate para terminales AISLADOS**

**Refer:** 3010-PR **Precio €** 4,93

Para terminales de 0.5 a 6 mm<sup>2</sup>

**Alicate para terminales SIN AISLAR**

**Refer:** 3020-PR **Precio €** 7,56

Para terminales de 0.5 a 6 mm<sup>2</sup>

**Alicate para terminales MIXTOS**

**Refer:** 3030-PR **Precio €** 6,94

Para terminales de 0.5 a 6 mm<sup>2</sup>

<b>Terminales Machos Desnudos</b>						
	<b>Refer:</b>	<b>Descripción</b>	<b>Medida</b>	<b>Sección</b>		<b>Precio €</b>
	873272-ELM	Macho Desnudo	2.8 x 0.8	0.5 - 1	100	6,50
	873272/B-ELM	Macho Desnudo	4.8 x 0.8	0.5 - 1	100	9,40
	873272/C-ELM	Macho Desnudo	6.3 x 0.8	1 - 2.5	100	9,75

<b>Terminales Hembras Desnudos</b>						
	<b>Refer:</b>	<b>Descripción</b>	<b>Medida</b>	<b>Sección</b>		<b>Precio €</b>
	27TLH2800-LER	Hembra Desnudo	2.8 x 0.8	0,5 - 1	100	4,10
	27TLH4800-LER	Hembra Desnudo	4.8 x 0.8	0.5 - 1	100	5,40
	27TLH6300-LER	Hembra Desnudo	6.3 x 0.8	1 - 2,5	100	5,40

<b>Terminales Cerrados Pre-aislados</b>					
<u>Refer:</u>	<u>Descripción</u>	<u>Int - Ext</u>	<u>Sección</u>		<u>Precio €</u>
3206-ELM	Cerrado azul	3.7 x 8,7	1.50 - 2.5	100	6,90
3209-ELM	Cerrado azul	6.4 x 12	1.50 - 2.5	100	7,04
3208-ELM	Cerrado azul	8.4 x 12	1.50 - 2.5	100	8,40
3212-ELM	Cerrado azul	10.5 x 13.5	1.50 - 2.5	100	8,75
3213-ELM	Cerrado amarillo	4.3 x 7.2	2.5 - 6	100	7,65

<b>Terminales Hembra Pre-aislados</b>					
<u>Refer:</u>	<u>Descripción</u>	<u>Medida</u>	<u>Sección</u>		<u>Precio €</u>
3244-PR	Hembra rojo	6.3 x 0.8	0.5 - 1.5	100	6,55
3246-PR	Hembra rojo	4.8 x 0.8	0.5 - 1.5	100	5,99
3244/B-PR	Hembra rojo	2.8 x 0.8	0.5 - 1.5	100	5,70
3248-PR	Hembra azul	6.3 x 0.8	1.0 - 2.5	100	7,12
3248/B-PR	Hembra azul	4.8 x 0.8	1.0 - 2.5	100	6,41

<b>Terminales Macho Pre-aislados</b>					
<u>Refer:</u>	<u>Descripción</u>	<u>Medida</u>	<u>Sección</u>		<u>Precio €</u>
3270-PR	Macho rojo	6.3 x 0.8	0.5 - 1.5	100	6,75
3272/B-ELM	Macho rojo	4.8 x 0.8	0.5 - 1.5	100	5,34
3270/B-ELM	Macho rojo	2.8 x 0.8	0.5 - 1.5	100	4,97
3271-PR	Macho azul	6.3 x 0.8	1.0 - 2.5	100	7,83
3271/B-ELM	Macho azul	4.8 x 0.8	1.0 - 2.5	100	6,24

<b>Terminales Canuto Pre-aislados</b>					
<u>Refer:</u>	<u>Descripción</u>	<u>Medida</u>	<u>Sección</u>		<u>Precio €</u>
3292-PR	Hembra rojo	M-4	0.5 - 1.5	100	10,38
3293-PR	Hembra azul	M-5	1.0 - 2.5	100	11,27

<b>Terminales Puntera Pre-aislados</b>					
<u>Refer:</u>	<u>Descripción</u>	<u>Medida</u>	<u>Sección</u>		<u>Precio €</u>
3290-PR	Macho rojo	M-4	0.5 - 1.5	100	7,12
3291-PR	Macho azul	M-4	1.0 - 2.5	100	7,27
3291/B-PR	Macho azul	M-5	1.0 - 2.5	100	10,28

<b>Terminales Horquilla Pre-aislados</b>						
<u>Refer:</u>	<u>Descripción</u>	<u>Medida</u>	<u>Sección</u>		<u>Precio €</u>	
3223-PR	Horquilla rojo	3.2 x 6.4	0.5 - 1.5	100	8,32	
3225-PR	Horquilla azul	3.7 x 6.8	1.0 - 2.5	100	9,98	

<b>Terminales Punta Fina Pre-aislados</b>						
<u>Refer:</u>	<u>Descripción</u>	<u>Medida</u>	<u>Sección</u>		<u>Precio €</u>	
3280-PR	Puntera rojo	M-1.7	0.5 - 1.5	100	10,76	
3281-PR	Puntera azul	M-2.3	1.0 - 2.5	100	10,76	

<b>Terminales Empalme Pre-aislados</b>						
<u>Refer:</u>	<u>Descripción</u>	<u>Medida</u>	<u>Sección</u>		<u>Precio €</u>	
3294-PR	Cilíndrico rojo	M-4	0.5 - 1.5	100	8,10	
3295-ELM	Cilíndrico azul	M-5	1.0 - 2.5	100	7,70	

<b>Terminales Hembra 100% Aislados</b>						
<u>Refer:</u>	<u>Descripción</u>	<u>Medida</u>	<u>Sección</u>		<u>Precio €</u>	
3244/C-PR	Hembra rojo	6.3 x 0.8	0.5 - 1.5	100	7,70	
3248/C-PR	Hembra azul	6.3 x 0.8	1.0 - 2.5	100	8,55	

<b>Regletas de Conexión Blancas y Negras</b>					<u>Precio €</u>
<u>Refer</u>	<u>Blanco</u>	<u>Negro</u>	<u>Medidas</u>	<u>Cantidad</u>	<u>Paquete</u>
870403/	✓	✓	4 mm x 3 A	5 Tiras	1,90
871204/	✓	✗	4 mm x 3 A	10 Tiras	3,80
870606/	✓	✗	6 mm x 6 A	5 Tiras	2,45
871215/	✓	✓	12 mm x 15 A	5 Tiras	4,30
871420/	✓	✓	14 mm x 20 A	5 Tiras	4,50
871632/	✓	✗	16 mm x 32 A	10 Tiras	19,38
872560/	✓	✗	25 mm x 60 A	5 Tiras	18,90

	<b>Buscapolos de 125-250 V.</b>	<b>Refer:</b> 660003	30		140	<b>Precio €</b> 1,05
	<b>Buscapolos Profesional 250 V.</b>	<b>Refer:</b> 566/150-PAD 566/190-PAD	10 10	150 190	<b>Precio €</b> 2,98 3,64	
	<b>Buscapolos de Pinza de 6-24 V.</b>	<b>Refer:</b> 580-PR		135	<b>Precio €</b> 2,47	
	<b>Buscapolos de Aguja de 6-24 V.</b>	<b>Refer:</b> 585-PR		115	<b>Precio €</b> 3,64	

	<b>Soldador Eléctrico 40 W</b>	<b>Refer:</b> 3044E024-TOP	<b>Precio €</b> 14,05
		Certificación CE Voltage: 230	<b>Tipo</b> Punta Pico



**Juego Puntas XZN cogida 10 mm, 11 pzs.**

**Refer:**  
210/01-PR

**Precio €**  
19,12

Puntas M5, M6, M8, M10 y M12 x 30 mm  
Puntas M5, M6, M8, M10 y M12 x 75 mm  
Adaptador 1/2 x 10 mm



**Juego Puntas HEX cogida 10 mm, 15 pzs.**

**Refer:**  
210/02-PR

**Precio €**  
20,58

Puntas 4, 5, 6, 7, 8, 10 y 12 x 30 mm  
Puntas 4, 5, 6, 7, 8, 10 y 12 x 75 mm  
Adaptador 1/2 x 10 mm



**Juego Puntas TORX cogida 10 mm, 11 pzs.**

**Refer:**  
210/03-PR

**Precio €**  
20,80

Puntas T20, T25, T30, T40, T45, T50 y T55 x 30 mm  
Puntas T20, T25, T30, T40, T45, T50 y T55 x 75 mm  
Adaptador 1/2 x 10 mm





**Puntas XZN, HEX y TORX**

**Refer:** cogida 10 mm 40 pzs. **Precio €**  
210/04-PR 45,58

XZN M5, M6, M8, M10 y M12 x 30 y 75 mm

HEX M4, M5, M6, M7, M8, M10 y M12 x 30 y 75 mm

TORX T20, T25, T30, T40, T45, T50 y T55 x 30 y 75 mm

Adaptadores de 1/2 x 10 mm y 3/8 x 10 mm



**Juego Puntas RIBE cogida 10 mm, 21 pzs.**

**Refer:** 210/05-UPO **Precio €**  
33,15

Puntas 5, 6, 7, 8, 9, 10, 11, 12 y 13 x 40 mm  
Puntas 5, 6, 7, 8, 9, 10, 11, 12, 13 y 14 x 75 mm  
Adaptadores de 1/2 x 10 mm y 3/8 x 10 mm

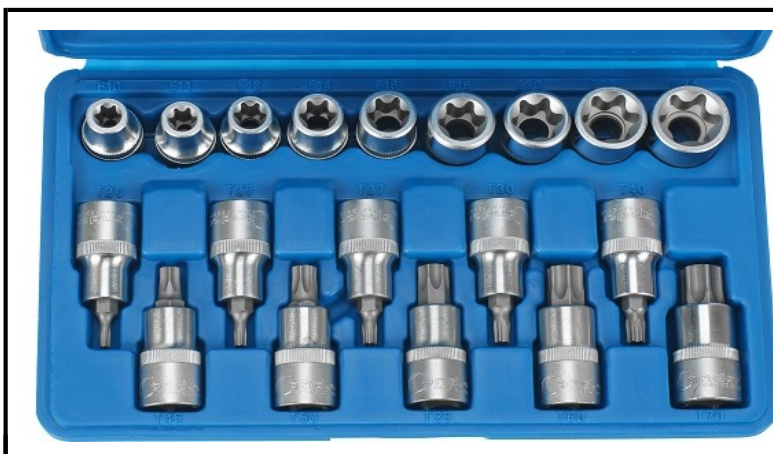
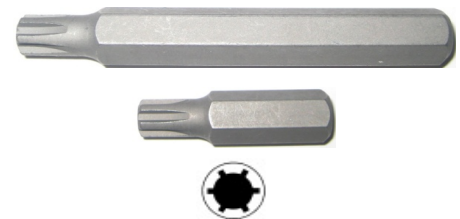

**Juego TORX INVOLABLE de 1/2", 19 pzs.**

**Refer:** 1008-PR **Precio €**  
58,60

Vasos 1/2":

E10, E11, E12, E14, E16, E18 y E20, E22 y E24

Vasos-Punta de 1/2":

T20, T25, T27, T30, T40, T45, T50, T55, T60 y T70





1/4"  
3/8"



**Vasos TORX Hembra, 12 pzs.**

Refer:  
1006-PR

E4, E5, E6, E7 y E8 x 1/4"

E10, E11, E12, E14, E16, E18 y E20 x 3/8"

Precio €  
18,90



1/4"



**Vasos-Punta TORX, 10 pzs.**

Refer:  
1004/1-PR

T7, T8, T9, T10, T15, T20, T25, T27, T30 y T40

Precio €  
12,39



1/4"



**Vasos-Punta TS 5 LADOS, 9 pzs.**

Refer:  
1108-PR

TS10, TS15, TS20, TS25, TS30, TS40, TS45 y TS50

Precio €  
17,86



**Juegos de Vasos Hexagonales, Serie Larga**

Refer:

1009/14-PR 4, 5, 5.5, 6, 7, 8, 9, 10, 11, 12, 13 - 1/4"  
1009/38-PR 8, 10, 11, 12, 13, 14, 15, 16, 17, 18, 19 - 3/8"  
1009/12-PR 10, 13, 15, 17, 19, 22, 24 - 1/2"

Precio €

25,42  
35,08  
44,74

1/4"

3/8"

1/2"

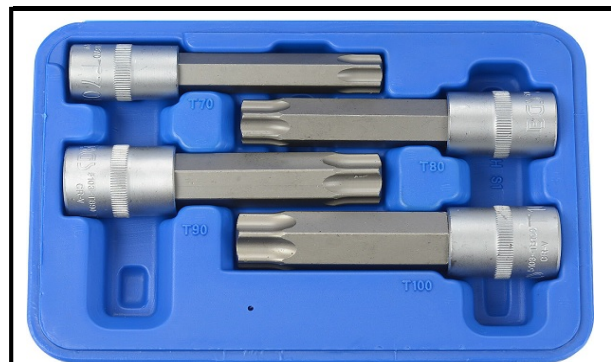

**Juego de Vasos - Punta Torx, 4 pzs.**

Refer:

5004-PR

TX-70, TX-80, TX-90, TX-100

En estuche de plástico

1/2"



Precio €  
39,79



**Juego de Vasos XZN de 1/2", 16 pzs.**

**Refer:**  
1016/12K-PR

**Precio €**  
36,76

8, 9, 10, 11, 12, 13, 14, 15, 16,  
17, 18, 19, 20, 21, 22 y 24 mm

En estuche de plástico



**Juego de Vasos TORX de 1/2", 9 pzs.**

**Refer:**  
1007-PR

**Precio €**  
28,36

E10, E11, E12, E14, E16, E18, E20, E22 y E24

En estuche de plástico



**Vasos de Impacto de 1/2", 10 pzs.**

**Refer:**  
1010/12-PR

**Precio €**  
36,34

10, 12, 13, 14, 15, 17, 19, 21, 22 y 24 mm



**Refer:**  
1010/12T-PR

**Precio €**  
59,86

Serie Larga

10, 12, 13, 14, 15, 17, 19, 21, 22 y 24 mm





**Llave Inglesa ajustable Semiprofesional**

Refer:	↔	📦	Precio €
237/06-TOM	6"	6	4,78
237/08-TOM	8"	6	6,38
237/10-TOM	10"	6	7,75
237/12-TOM	12"	6	10,35
237/15-TOM	15"	6	24,45
237/18-TOM	18"	1	31,80
237/24-TOM	24"	1	59,75

**Llave Inglesa ajustable Profesional milimetrada FULCO**

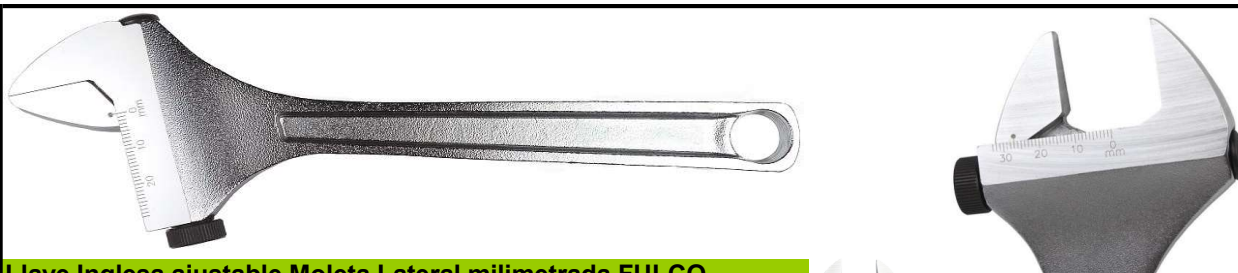
Refer:	↔	📏	📦	Precio €
241/06M-PRO	6"	23,9 mm	10	10,92
241/08M-PRO	8"	28,6 mm	12	13,86
241/10M-PRO	10"	32,8 mm	12	17,45
241/12M-PRO	12"	38,1 mm	5	21,77
241/15M-PRO	15"	50 mm	1	46,76

**Llave Inglesa ajustable Moleta Lateral milimetrada FULCO**

Refer:	↔	📏	📦	Precio €
238/06C-PRO	6"	23,9 mm	12	16,63
238/08C-PRO	8"	28,6 mm	6	19,30
238/10C-PRO	10"	32,8 mm	6	26,30

**Llave Inglesa ajustable Gran Apertura milimetrada Profesional**

Refer:	↔	📏	📦	Precio €
239/06C-PRO	6"	34 mm	6	11,76
239/08C-PRO	8"	39 mm	6	15,60
239/10C-PRO	10"	50 mm	6	23,76



**Remachadora Profesional**

**Refer:**  
235-PR

**Precio €**  
20,89

Para Remaches de: 2.4 - 3.2 - 4.0 - 4.8



**Remachadora Profesional en Estuche**

**Refer:**  
236-PR

**Precio €**  
28,86

Para Remaches de: 2.4 - 3.2 - 4.0 - 4.8

En estuche de plástico con 100 remaches



Especial para apriete de piezas de polietileno

**Llave Articulada Ajustable**

Refer:	Rango de apertura	Precio €
4480/2-TOM	35 a 50 mm	16,99
4480/3-TOM	50 a 80 mm	30,25
4480/4-TOM	80 a 120 mm	37,20



**Estuche Puntas y Carraca reversible, 25 pzs.**

**Refer:**  
8335/25-WH

**Precio €**  
44,25

Puntas XZN de 5-6-8 y 10 mm

Puntas Torx de 10-15-20-25-27 y 30.

Puntas Hex de 2.5-3-4-5-6-7-8 y 10 mm

Puntas PH 1, 2, 3 y 4.

Puntas Planas de 4 y 6.5 mm

Carraca de 72 dientes cogida Bi-Hexagonal de 10 mm

En estuche de plástico con cierre metálico.

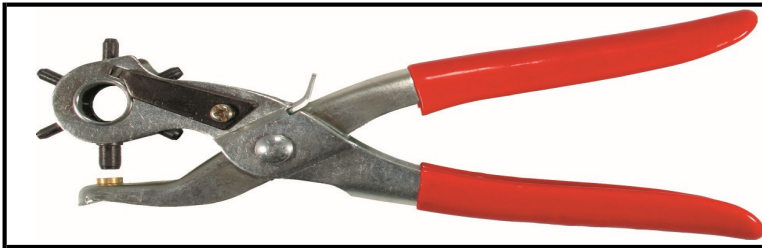

**Sacabocados Manual Bricolage**

**Refer:**  
268-PR

**Precio €**  
6,02

Ideal para plástico, goma, cuero, cartón, etc.

Mango Plastificado



**Sacabocados Manual Profesional**

**Refer:**  
3032D424-TOP



**Precio €**  
22,71

Ideal para plástico, goma, cuero, cartón, etc.

Mango Plastificado

Ø : 2 , 2.5 , 3 , 3.5 , 4 y 4.5 mm.



**Mini Bomba de engrase manual**

**Refer:**  
3985-PR

**Precio €**  
26,23

Depósito de 120 grs.

Cuerpo de acero cromado.

Latiguillo de engrase rígido de 170 mm.

Latiguillo de engrase flexible de 230 mm.

Barra extensora 115 mm + Boquillas



**Latiguillos para Bombas de Engrase**

**Refer:**  
3980/A-PR  
3980/B-PR

Latiguillo flexible 300 mm  
Latiguillo flexible 480 mm

**Precio €**  
7,35  
8,75



**Boquillas para Bombas de Engrase**

**Refer:**  
3980/D

Boquilla engrase 4 garras

**Precio €**  
2,75



**Carraca Mini Reversible de 1/4" para vasos y puntas**

**Refer:**  
967242-WH

- Cuadradillo macho para llaves de vaso de 1/4"
- Hexágono hembra para puntas de atornillador de 1/4"

**Precio €**  
7,96



**Carraca de 1/2" Extensible**

**Refer:**  
1208/12-WH

Extensible de 305 a 445 mm  
Carraca de 1/2" de 72 dientes

**Precio €**  
43,47



**Carraca de 3/4" Profesional**

**Refer:**  
22550-PR

Carraca de 3/4" de 36 dientes

**Precio €**  
98,39



**Llaves Dinamométricas**

Refer:	Descripción			Precio €
95/000-PR	De 0,1 a 0,5 K # De 1 a 5 Newtons/Metro	1/4"	Cierre Rápido	82,50
95/00-PR	De 0,6 a 3 K # De 6 a 30 Newtons/Metro	1/4"	Cierre Rápido	99,76
95/0-PR	De 0,6 a 3 K # De 6 a 30 Newtons/Metro	3/8"	Cierre Rápido	99,76
8144-3	De 2 a 20 K # De 20 a 200 Newtons/Metro	1/2"	Cierre Rápido	117,20
95/3-PR	De 7 a 35 K # De 70 a 350 Newtons/Metro	1/2"	Cierre Rápido	121,50



**Goniómetro con cogida de 1/2"**
**Refer:**

98-PR

Medición de 0 a 360°  
 Medidor de ángulo para llave dinamométrica o carraca.  
 Mide el ángulo de rotación después del par de torsión.

**Precio €**

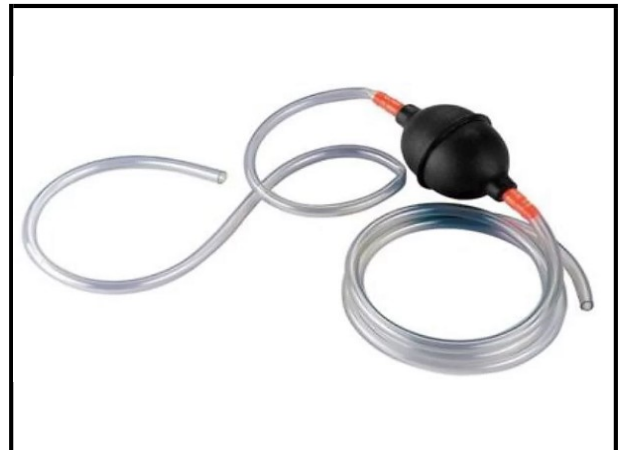
13,51

**Bomba Perilla Trasvase Líquidos**
**Refer:**

256

Longitud: 1,60 mts

Para trasvase de líquidos de un depósito a otro.

**Precio €**

7,56

**Barras de Termofusión Transparentes**

Refer:		Medida	Precio €
3173260-YT	Blíster con 12 barras	7 mm x 100 mm	1,78
3173271-YT	Blíster con 12 barras	11,2 mm x 150 mm	5,25
104100-BM	Bolsa con 33 barras (1 kilo)	11,2 mm x 300 mm	17,56

**Pistolas de Termofusión**

Refer:	Ø	Potencia	Precio €
3042E581-TOP	7 mm	10 W	5,74
3042E500-TOP	11,2 mm	40 W	7,05



**Pata de Cabra Octogonal**

Refer:	mm	Precio €
81/1-TOM	16 x 20 x 28 x <b>450</b> mm	6,43
81/2-TOM	16 x 27 x 31 x <b>600</b> mm	9,80
81/3-TOM	18 x 30 x 34 x <b>800</b> mm	13,60



**Palanqueta Arquetas Engomada**

Refer:	mm	Precio €
2431-TOM	350 mm	6,22



**Palanqueta Grapas Clips**

Refer:	mm	Precio €
15409-WH	200 mm	7,72



**Desmontadores de Cubiertas**

Refer:	mm	Precio €
165/250-PR	19 mm de ancho x 6 mm de espesor x <b>250</b> mm de largo	7,14
165/300-PR	23 mm de ancho x 8 mm de espesor x <b>300</b> mm de largo	7,85
165/400-PR	23 mm de ancho x 8 mm de espesor x <b>400</b> mm de largo	8,50
165/500-HR	23 mm de ancho x 8 mm de espesor x <b>500</b> mm de largo	9,40
165/600-HR	26 mm de ancho x 11 mm de espesor x <b>600</b> mm de largo	10,30

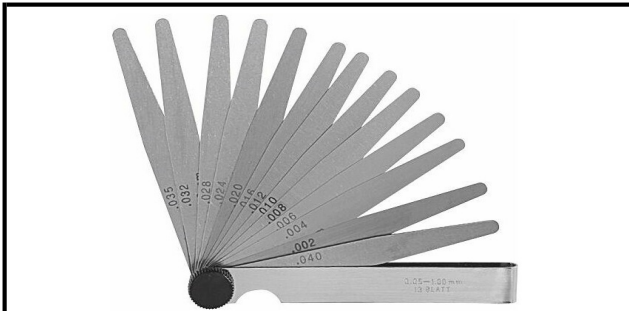

**Galgas de espesores**

Refer:		Precio €
171-PR	13 galgas de 0.05 a 1.00 mm	4,22
172-PR	20 galgas de 0.05 a 1.00 mm	6,75

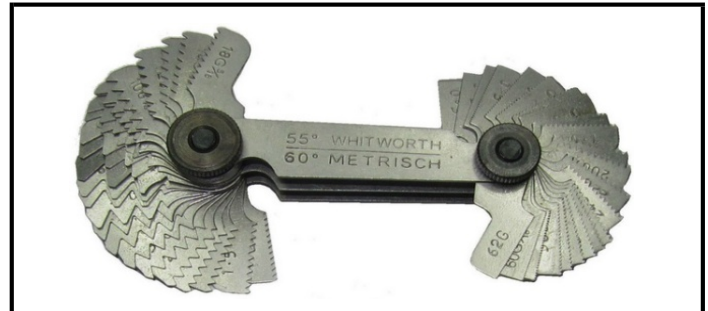

**Medidores de roscas**

Refer:		Precio €
184-PR	24 hojas de Métrica	7,14
185-PR	52 hojas Métrica y Pulgadas	11,56



**Llave de 3 garras para Filtros de Aceite**

Refer:		Precio €
251-PR	* Para Filtros de 65 a 130 mm * Incluye Hexágono de 21 mm * Cogida de 3/8" + Adaptador de 1/2"	15,15

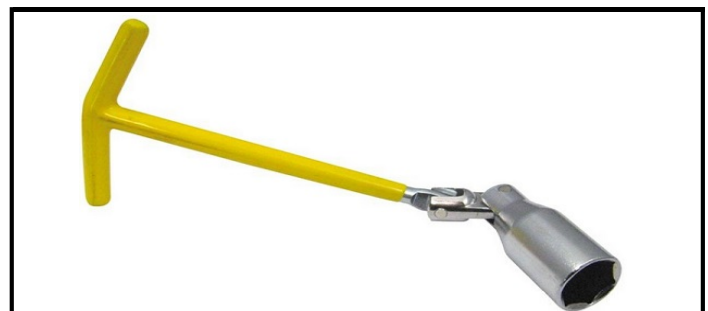

**Llaves para Bujías**

Refer:	Medidas	Precio €
245/16-TOM	Para bujías de 16 mm	4,84
245/21-TOM	Para bujías de 21 mm	4,95



**Extractores de Tornillos rotos**

Refer:		Precio €
101115-TOM	5 pzs De M3 a M18	5,04
176/T-PR	6 pzs De M3 a M24	7,17



**Extractores de Tuercas Insertadas**

Refer:	Medidas	Precio €
17638	3/8" / M24-M33	3,85
17612	1/2" / M33-M45	5,34



**Llave de Fleje Metálico para Filtros**

Refer:	Precio €
3157610	8,81

**Longitud**  
200 mm

**Rango apertura**  
55 mm - 110 mm



**Fresa Metal Duro Cilíndrica**

**Refer:**  
444/01-TOM Tipo A 12 x 25 x 65

**Precio €**  
18,94

**Fresa Metal Duro Cilíndrica Esférica**

**Refer:**  
444/02-TOM Tipo C 12 x 25 x 65

**Precio €**  
18,94

**Fresa Metal Duro Esférica**

**Refer:**  
444/03-TOM Tipo D 12 x 10 x 51

**Precio €**  
16,75

**Fresa Metal Duro Oval**

**Refer:**  
444/04-TOM Tipo E 12 x 20 x 60

**Precio €**  
18,22

**Fresa Metal Duro Ojival**

**Refer:**  
444/05-TOM Tipo F 12 x 25 x 65

**Precio €**  
18,94

**Fresa Metal Duro Cónica**

**Refer:**  
444/06-TOM Tipo M 12 x 25 x 65

**Precio €**  
18,22

**Fresa Metal Duro Cilíndrica Corte**

**Refer:**  
444/07-TOM Tipo B 12 x 25 x 65

**Precio €**  
18,94



\* Especial bombillos

**Fresa Metal Duro Cilíndrica Esférica**

**Refer:**  
444/08-TOM Tipo C 6 x 16 x 56

**Precio €**  
14,85

**Juegos de Machos de Roscar HSS-G Rectificados**

Refer:			Precio €
155/03-PR	M3 x 0.5	2,5 mm	7,68
155/04-PR	M4 x 0.7	3,3 mm	7,68
155/05-PR	M5 x 0.8	4,2 mm	8,25
155/06-PR	M6 x 1.00	5,0 mm	9,52
155/07-PR	M7 x 1.00	6,0 mm	9,96
155/08-PR	M8 x 1.25	6,8 mm	10,23
155/10-PR	M10 x 1.50	8,5 mm	14,86
155/12-PR	M12 x 1.75	10,2 mm	16,93
155/14-PR	M14 x 2.00	12,0 mm	25,03
155/16-PR	M16 x 2.00	14,0 mm	33,64

**Giramachos en T con Carraca Reversibles**

Refer:		L mm	Precio €
159/1-PR	M3 - M10 1/8" - 3/8"	85	11,45
159/2-PR	M5 - M12 7/32" - 1/2"	115	13,56

Para roscados de izquierda y de derecha

Mango corredizo

**Giramachos Manual DIN 1814**

Refer:		L mm	Precio €
157/12-TOM	M1,5 - M12	185	4,07

**Terraja Circular Hss DIN 223**

Refer:		Precio €
158/04-TOM	M4 x 0,7 x 20	5,05
158/05-TOM	M5 x 0,8 x 20	5,05
158/06-TOM	M6 x 1,0 x 20	5,05
158/08-TOM	M8 x 1,25 x 25	5,85
158/10-TOM	M10 x 1,50 x 30	11,42
158/12-TOM	M12 x 1,75 x 38	17,80

**Giraterajas Manual DIN 225**

Refer:		L mm	Precio €
153/01-TOM	M3 - M4 x 20 x 5	175	5,32
153/02-TOM	M4,5 - M6 x 20 x 7	175	4,84
153/03-TOM	M7 - M9 x 25 x 9	210	6,08
153/04-TOM	M10 - M11 x 30 x 11	260	9,43
153/05-TOM	M12 - M14 x 38 x 14	310	12,60



**Helicoil Roscas Insertos roscados, 30 pzs**

Refer:		L mm	Precio €
152/04-TOM	M4 x 0.7	2 mm	6,50
152/05-TOM	M5 x 0.8	3 mm	6,75
152/06-TOM	M6 x 1.00	5 mm	7,05
152/08-TOM	M8 x 1.25	7 mm	8,50
152/10-TOM	M10 x 1.50	13 mm	12,50



**Juego Helicoil Roscas + Accesorios, 18 pzs**

Refer:		L mm	Precio €
150/04-TOM	M4 x 0.7	2 mm	24,64
150/05-TOM	M5 x 0.8	3 mm	25,07
150/06-TOM	M6 x 1.00	5 mm	25,23
150/08-TOM	M8 x 1.25	7 mm	27,71
150/10-TOM	M10 x 1.50	13 mm	32,42





**Juego Machos Combinados Hss-G, 7 p.**

**Refer:** 151-TOM **Precio €** 53,55  
M3 - M4 - M5 - M6 - M8 - M10 + Adaptador



**Machos Combinados Hss-G**

Refer:		Precio €
151/03-TOM	M3	8,10
151/04-TOM	M4	8,35
151/05-TOM	M5	8,55
151/06-TOM	M6	9,25
151/08-TOM	M8	9,75
151/10-TOM	M10	10,50



**Juego de Machos y Terrajas, 20 p.**

**Refer:** 154/20-TOM **Precio €** 28,93

Machos y Terrajas de M3 a M12  
Giramachos y Giraterajas de 200 mm  
Material: Acero al Carbono  
**Calidad Bricolage**



**Juego de Machos y Terrajas, 32 p.**

**Refer:** 154/32-TOM **Precio €** 83,05

Machos y Terrajas de M3 a M12  
Giramachos de 180 mm y Giraterajas de 200 mm  
Medidor de Roscas Métrico  
Destornillador Plano  
Material: Hss-G  
Estuche Metálico  
**Calidad Profesional**

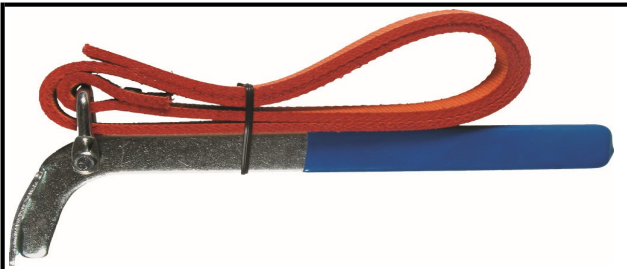
**Llave de Cuero para Filtros de Aceite**

Refer: 257 Largo cinta: 720 mm Precio € 12,18

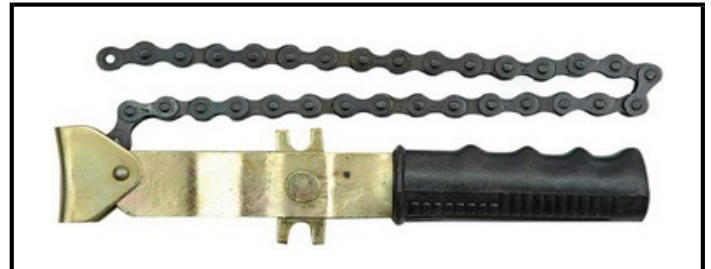
**Llave de Cadena para Filtros de Aceite**

Refer: 93-PR Largo cadena: 300 mm Precio € 4,58

**Botadores Cilíndricos**

Refer:	Medidas	Precio €
271/02-ELO	2 x 140 x 40	5,60
271/03-ELO	3 x 150 x 40	5,81
271/035-ELO	3,5 x 150 x 40	6,75
271/04-ELO	4 x 190 x 40	7,82
271/05-ELO	5 x 200 x 50	7,92
271/06-ELO	6 x 210 x 50	8,25
271/08-ELO	8 x 215 x 50	8,50

**Juego de Botadores, 6p.**

Refer: 659-PR Medidas 3, 4, 5, 6, 7 y 8 mm x 150 mm Precio € 18,48

**Granetes Cónicos**

Refer:	Medidas	Precio €
3003A441-TOP	6,3 x 100	2,20
3003A442-TOP	9,4 x 127	2,70
3003A445-TOP	12,7 x 152	3,75

**Avellanador Metal Hss**

Refer:	Ø	Precio €
447/06-TOM	6,3 mm	4,28
447/08-TOM	8,3 mm	5,49
447/10-TOM	10,4 mm	5,95

**Avellanador Madera con Broca**

Refer:	Ø Tornillos	Precio €
100106-WH	3 - 3,5 mm	6,87
100108-WH	4 - 4,5 mm	6,87

**Avellanador Madera 90° de 5 Cortes**

Refer:	Ø	Precio €
446/16-TOM	16 mm	4,18



**Juego de Vasos-Punta Hex PULGADAS, 7 pzs.**

Refer:  
5107-PR

Precio €  
14,92

**3/8"**



1/8, 5/32, 3/16, 7/32, 1/4, 5/16 y 3/8



**Juego de Vasos PULGADAS Largos, 10 pzs.**

Refer:  
21212-PR

Precio €  
19,44

**1/4"**



5/32, 3/16, 7/32, 1/4, 9/32, 5/16,  
11/32, 3/8, 7/16 y 1/2



**Juego de Vasos PULGADAS, 11 pzs.**

Refer:  
21211-PR

Precio €  
12,77

**1/4"**



3/16, 7/32, 1/4, 9/32, 5/16, 11/32,  
3/8, 13/32, 7/16, 15/32 y 1/2



**Juego de Vasos PULGADAS, 24 pzs.**

Refer:  
1194-PR

Precio €  
58,54

**1/4"**



5/32, 3/16, 7/32, 1/4, 9/32, 5/16, 11/32,  
3/8, 13/32, 7/16 y 15/32

**1/2"**

1/2, 9/16, 19/32, 5/8, 11/16, 3/4, 13/16,  
7/8, 15/16, 1, 1.1/16, 1.1/8 y 1.1/4



Acabado: Niquelado

Material: Acero Cromo Vanadio Templado



**Llaves Allen Acodadas calidad "Profesional"**

Refer:					Precio €
58/015-WH	1,5	46	15	10	0,58
58/02-WH	2	51	18	10	0,67
58/025-WH	2,5	57	20	10	0,77
58/03-WH	3	64	23	10	0,84
58/04-WH	4	72	29	10	1,23
58/05-WH	5	83	33	10	1,58
58/06-WH	6	94	38	10	1,85
58/07-WH	7	95	34	10	2,65
58/08-WH	8	105	44	10	2,77
58/09-WH	9	114	47	10	3,29
58/10-WH	10	122	50	5	4,33
58/11-WH	11	129	53	5	4,75
58/12-WH	12	134	57	5	6,82
58/13-TOP	13	145	63	3	7,77
58/14-WH	14	151	70	3	10,70
58/17-WH	17	173	80	3	16,96
58/19-WH	19	195	89	3	19,57
58/22-WH	22	217	102	3	22,35





**Llaves Allen en Anilla, 10 pzs**

Refer: 168/B-UPO

Precio € 4,82

1.5, 2, 2.5, 3, 4, 5, 5.5, 6, 8 y 10 mm



**Llaves Allen Bola Largas en PULGADAS, 9 pzs**

Refer: 1121Z-PR

Precio € 17,22

1/16, 5/64, 3/32, 1/8, 5/32, 3/16, 1/4, 5/16 y 3/8





**Llaves TORX tipo Navaja, 8 pzs**

Refer: 3035D959-TOP

Precio € 6,47

4,55

TX 9, 10, 15, 20, 25, 27, 30 y 40







**Llaves TORX INV - ALLEN acodadas, 18 pzs**

**Refer:**  
169-TOM

**Precio €**  
17,52

TX 10, 15, 20, 25, 27, 30, 40, 45 y 50

1.5, 2, 2.5, 3, 4, 5, 6, 8 y 10 mm



En estuche de plástico rígido y resistente



**Juego Fresas Rotativas Metal Hss, 5 pzs**

**Refer:**  
440-TOM

**Precio €**  
67,37

**Formas**

Cilíndrica A 10 x 20 x 60 mm

Esférica C 10 x 20 x 60 mm

Esférica D 10x 9 x 49 mm

Oval E 10 x 16 x 56 mm

Cónica M 10 x 20 x 60 mm



**Juego Avellanadores Metal Hss, 6 pzs**

**Refer:**  
447-TOM

**Precio €**  
45,67

∅  
6,3 mm - 8,3 mm - 10,4 mm - 12,4 mm - 16,5 mm - 20,5 mm





**Llaves XZN acodadas "Elora"**

Calidad: Cr 50 V 4

Refer:				Precio €
160/05-ELO	72	25	M-5	3,55
160/06-ELO	80	28	M-6	4,36
160/12-ELO	112	40	M-12	7,98



**Llaves RIBE acodadas "Elora"**

Calidad: Cr 50 V 4

Refer:				Precio €
161/04-ELO	60	20	M-4	3,00
161/10-ELO	100	36	M-10	6,82
161/12-ELO	112	40	M-12	8,40



**Llaves TORX INVOLABLES acodadas**

Calidad: Acero S2

Refer:				Precio €
162/TTX08-WH	50	15	T-8	2,46
162/TTX09-WH	55	18	T-9	2,50
162/TTX10-WH	60	20	T-10	2,52
162/TTX15-WH	64	22	T-15	2,64
162/TTX20-WH	68	23	T-20	2,95
162/TTX25-WH	72	24	T-25	3,34
162/TTX27-WH	78	25	T-27	3,63
162/TTX30-WH	83	26	T-30	3,75
162/TTX40-WH	89	28	T-40	3,98
162/TTX45-WH	96	31	T-45	4,63
162/TTX50-WH	105	35	T-50	5,86



**Llaves TORX acodadas "Elora"**

Calidad: Cr 50 V 4

Refer:				Precio €
162/TX07-ELO	50,5	18,5	T-7	3,95
162/TXKU10-ELO	80	19	T-10 Bola	3,37
162/TX27-ELO	70	26,5	T-27	3,46
162/TXKU27-ELO	105	24	T-27 Bola	3,95



**Llaves TS de 5 LADOS Largas Acodadas**

Refer: 1124/EL9-PR

Precio € 28,36

Inviolables

TS10-15-20-25-27-30-40-45 y 50

9 piezas





**Espejo Flexible de Inspección**

Refer: 3568-PR

Ø 55 mm

↔ 500 mm

Precio € 8,43

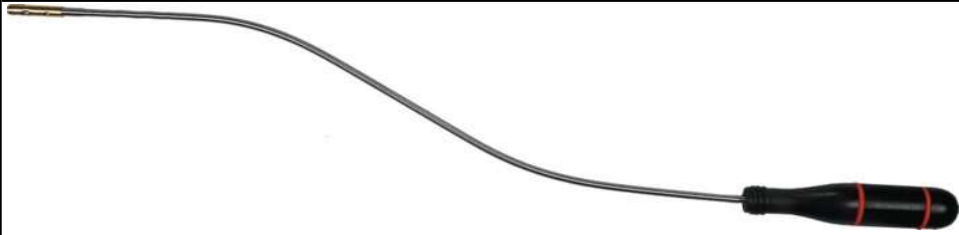

**Imán Flexibles con Mango**

Refer: 374/A-PR

g 0,5 kg

↔ 510 mm

Precio € 7,90



**Imán Extensible**

Refer: 373/A-PR

Capacidad Imán: 1,6 kg.  
Largo recogido: 170 mm.  
Largo extendido: 760 mm.

Precio € 8,93



**Imán Extensible con Punta**

Refer: 372-PR

Capacidad Imán: 0,5 kg.  
Largo recogido: 150 mm.  
Largo extendido: 650 mm.

Precio € 5,99



**Punta Grabadora Metálica**

Refer: 3740-TOM

Longitud: 145 mm.  
Clip para bolsillo.

Precio € 4,95



**Garra Flexible Metálica**

Refer: 427-PR

↔ 600 mm

Precio € 2,83





**Juego de Vasos VARIOPLUS 1/4", 13 pzs**

Refer: 2113-PR Precio € 17,55

**Especiales para: Hex - Hex Pulgadas - Torx - XZN**

Mm	Pulgadas	Torx
4 mm	5/32"	E 5
4,5 mm		E 6
5 mm	3/16"	
5,5 mm		
6 mm		E 8
7 mm	9/32"	
8 mm	5/16"	E 10
9 mm	11/32"	
10 mm	3/8"	E 12
11 mm	7/16"	E 14
12 mm	15/32"	E 16
13 mm	1/2"	
14 mm		E 18

**Juego de Vasos VARIOPLUS 1/2", 16 pzs**

Refer: 2116-PR Precio € 52,30

**Especiales para: Hex - Hex Pulgadas - Torx - XZN**

Mm	Pulgadas	Torx
8 mm	5/16"	E 10
9 mm	11/32"	
10 mm	3/8"	E 12
11 mm	7/16"	E 14
12 mm	15/32"	E 16
13 mm	1/2"	
14 mm		E 18
15 mm	19/32"	
16 mm	5/8"	E 20
17 mm		
18 mm		E 22
19 mm	3/4"	E 24
20 mm	25/32"	
21 mm	13/16"	
22 mm	7/8"	
24 mm	15/16"	



**Vasos BANLIN Hex / Pulgadas / Torx / Xzn de 1/2"**

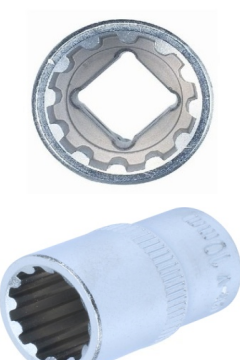

Refer:	Métrica	Pulgadas	Equivalente a TX	Precio €
1633/10C-WH	10 mm	3/8	E-12	3,00
1633/11C-WH	11 mm	7/16	E-14	3,00
1633/12C-WH	12 mm	15/32		3,00
1633/13C-WH	13 mm	1/2	E-16	3,00
1633/14C-WH	14 mm	9/16	E-18	3,00
1633/15C-WH	15 mm	19/32		3,05
1633/16C-WH	16 mm	5/8	E-20	3,05
1633/17C-WH	17 mm	21/32		3,23
1633/18C-WH	18 mm	11/16	E-22	3,42
1633/19C-WH	19 mm	3/4	E-24	3,42
1633/24-WH	24 mm	15/16		5,07

**Especiales para: Hex - Hex Pulgadas - Torx - XZN**

**Extractores de Rodamientos de 2 Brazos**

Refer:	Medidas	Precio €
141/075-PR	De 2 brazos x 75 mm	7,63
141/100-PR	De 2 brazos x 100 mm	11,31
141/150-PR	De 2 brazos x 150 mm	17,83

**Extractores de Rodamientos de 3 Brazos**

Refer:	Medidas	Precio €
142/075-PR	De 3 brazos x 75 mm	10,24
142/100-PR	De 3 brazos x 100 mm	16,33
142/150-PR	De 3 brazos x 150 mm	25,66

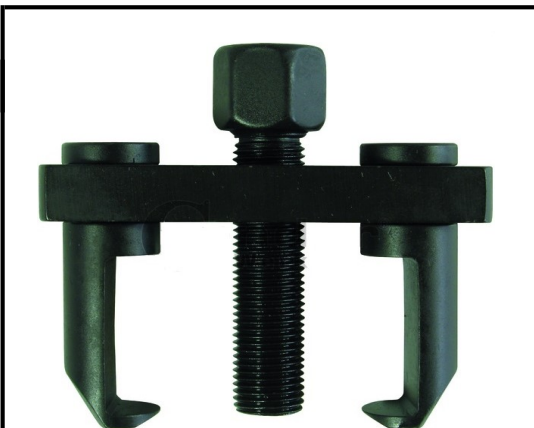
**Extractor 2 Patas Especial**

Refer:	Medidas	Precio €
4588-PR	Vw-Audi-Seat-Skoda	33,05

**Extractor 2 Patas Finas**

Refer:	Medidas	Precio €
3555-PR		23,50

**Juego de Numeradores de Golpe, 9 pzs.**

Refer:	Ø	Precio €
YT-6854	6 mm	8,85

**Juego de Abecedarios de Golpe, 27 pzs.**

Refer:	Ø	Precio €
YT-6862	6 mm	23,43
6862-TOM	8 mm	24,15

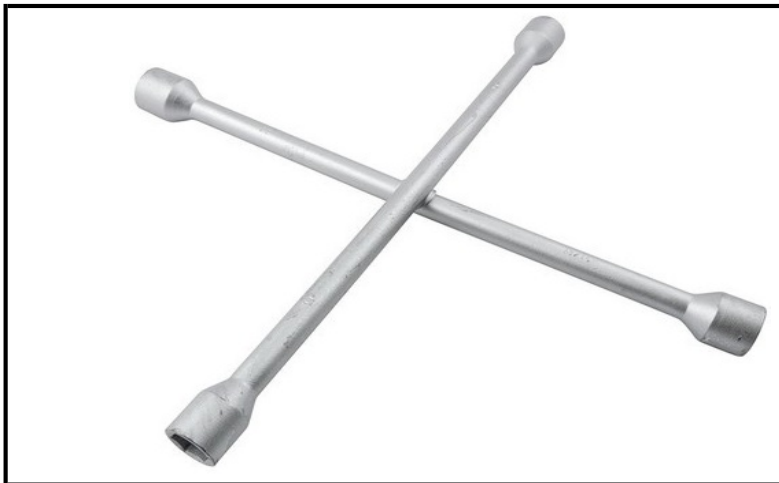

**Llave de Cruz para Ruedas**

**Refer:**  
87/3-TOM

**Precio €**  
12,05

**Medidas**  
17 mm x 19 mm x 21 mm x 23 mm

**Longitud**  
350 mm

**Diámetro**  
16 mm

**DIN 899**



**Llave de Rueda Extensible**

**Refer:**  
670231

**Precio €**  
16,95

Con vaso doble de 1/2" (17x19 y 21x23 mm)



**Llave Cuadrada para Cártér**

**Refer:**  
260-PR

**Medidas**  
8 - 10 mm

**Precio €**  
7,36

Para apertura dal tapón del cártér



**Tráctel con Cable de Arrastre**

**Refer:**  
3097X085-TOP  
3097X087-TOP

**Medidas**  
540 kg  
900 kg

**Precio €**  
52,95  
67,88

Especialmente indicado para los basculantes de los remolques.

**10 mts**



10 mm	3/8"	E 12
11 mm	7/16"	E 14
12 mm	15/32"	E 16
13 mm	1/2"	
14 mm	9/16"	E 18
15 mm	19/32"	
16 mm	5/8"	E 20
17 mm	21/32"	
18 mm	11/16"	E 22
19 mm	3/4"	E 24

**Juego BANLIN, Vasos, Llaves, Vasos-Punta y Carracas, 68 pzs**

Refer: 16310/68-WH

Precio € 212,91  
144,55



**Juego Llaves Mixtas BANLIN, 8 pzs**

Refer: 16313/08-WH En funda de lona Precio € 64,10

Hexagonal: de 8 a 19 mm.  
Hex Pulgadas: de 5/16" a 3/4".  
Torx: de E10 a E24.



**Juego Llaves Mixtas BANLIN, 8 pzs**

Refer: 16301/08-WH En estuche de plástico

Precio € 58,92

Hexagonal: de 8 a 19 mm.  
Hex Pulgadas: de 5/16" a 3/4".  
Torx: de E10 a E24.



**1/4"**
**Vasos Hexagonales de 1/4"**

Refer:	mm	Precio €
200/4-PR	4	1,37
200/5-PR	5	1,37
200/55-PR	5.5	1,37
200/6-PR	6	1,37
200/7-PR	7	1,37
200/8-PR	8	1,37
200/9-PR	9	1,43
200/10-PR	10	1,43
200/11-PR	11	1,43
200/12-PR	12	1,43
200/13-PR	13	1,57
200/14-PR	14	1,74

**3/8"**
**Vasos Hexagonales de 3/8"**

Refer:	mm	Precio €
199/08-PR	8	1,69
199/09-PR	9	1,69
199/10-PR	10	1,69
199/11-PR	11	1,72
199/12-PR	12	1,72
199/13-PR	13	1,72
199/14-PR	14	1,96
199/15-PR	15	1,96
199/16-PR	16	2,16
199/17-PR	17	2,40

**1/2"**
**Vasos Hexagonales de 1/2"**

Refer:	mm	Precio €
201/08-PR	8	3,42
201/09-PR	9	3,47
201/10-PR	10	3,51
201/11-PR	11	3,51
201/12-PR	12	3,80
201/13-PR	13	3,86
201/14SL-PR	14	3,86
201/15-PR	15	4,15
201/16-PR	16	4,15
201/17-PR	17	4,26
201/18SL-PR	18	4,26
201/19-PR	19	4,38
201/20-PR	20	4,38
201/21-PR	21	4,38
201/22SL-PR	22	4,42
201/23-PR	23	5,15
201/24-PR	24	5,15
201/25SL-PR	25	5,15
201/26SL-PR	26	5,15
201/27-PR	27	6,09
201/28-PR	28	6,09
201/29-PR	29	6,09
201/30SL-PR	30	6,37
201/32-PR	32	6,37
201/34-PR	34	8,46
201/35-PR	35	11,86
201/36-PR	36	14,80

**3/4"**
**Vasos Hexagonales de 3/4"**

Refer:	mm	Nº Lados	Precio €
771/19-PR	19	6	8,70
771/22-PR	22	6	8,70
771/23-PR	23	6	9,13
771/24-PR	24	6	9,13
771/26-PR	26	6	9,37
771/27-PR	27	6	9,37
771/28-PR	28	6	10,00
771/30-PR	30	6	10,24
771/32-PR	32	6	11,11
771/34-PR	34	6	12,93
771/36-PR	36	6	13,28
3008326-TOP	36	12	16,66
771/38-PR	38	6	16,76
3008327-TOP	38	12	16,66
771/41-PR	41	6	17,28
771/46-PR	46	6	18,50
771/48-PR	48	6	19,29
771/50-PR	50	6	23,29
771/55-PR	55	6	29,79
771/60-PR	60	6	34,29



1/4

**Vasos 1/4" Serie Larga**

Refer:	mm	Precio €
1009/1404-PR	4	2,47
1009/1405-PR	5	2,47
1009/14055-PR	5,5	2,47
1009/1406-PR	6	2,50
1009/1407-PR	7	2,50
1009/1408-PR	8	3,12
1009/1409-PR	9	3,12
1009/1410-PR	10	3,12
1009/1411-PR	11	3,30
1009/1412-PR	12	3,46
1009/1413-PR	13	3,63



3/8

**Vasos 3/8" Serie Larga**

Refer:	mm	Precio €
1009/3808-PR	8	3,21
1009/3810-PR	10	3,21
1009/3811-PR	11	3,46
1009/3812-PR	12	3,79
1009/3813-PR	13	3,79
1009/3814-PR	14	3,79
1009/3815-PR	15	3,79
1009/3816-PR	16	3,79
1009/3817-PR	17	4,62
1009/3818-PR	18	4,62
1009/3819-PR	19	4,94

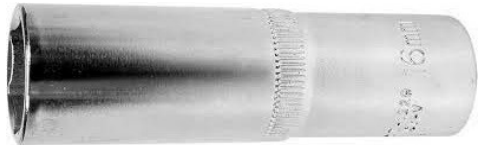

1/2

**Vasos 1/2" Serie Larga**

Refer:	mm	Precio €
17ZL/11-ELO	11	12,01
17ZL/12-ELO	12	12,01
17ZL/14-ELO	14	13,07
17ZL/15-ELO	15	15,57
17ZL/16-ELO	16	16,13
17ZL/18-ELO	18	16,13
17ZL/21-ELO	21	16,13
770/LTD27-ELO	27	16,68
17ZL/32-ELO	32	23,05
18ZL/10-PR	10	4,32
18ZL/11-PR	11	4,32
18ZL/12-PR	12	4,32
18ZL/13-PR	13	4,32
18ZL/14-PR	14	4,49
18ZL/15-PR	15	4,49
18ZL/16-PR	16	4,49
18ZL/17-PR	17	4,49
18ZL/18-PR	18	5,31
18ZL/19-PR	19	5,31
18ZL/20-PR	20	6,10
18ZL/21-PR	21	6,10
18ZL/22-PR	22	6,76
18ZL/24-PR	24	8,08
18ZL/27-PR	27	10,30
18ZL/30-PR	30	12,31
18ZL/32-PR	32	12,87



**Vasos TORX Hembra**

Refer:		Precio €
22400/E04-PR	1/4 x E4	2,13
22400/E05-PR	1/4 x E5	2,13
22400/E06-PR	1/4 x E6	2,13
22400/E07-PR	1/4 x E7	2,13
22400/E08-PR	1/4 x E8	2,13
22400/E10-PR	1/4 x E10	2,37
22400/E11-PR	1/4 x E11	2,37
770/E3810-TOM	3/8 x E10	2,30
770/E3812-TOM	3/8 x E12	2,30
770/E3814-TOM	3/8 x E14	2,30
770/E3816-TOM	3/8 x E16	2,97
770/E3818-TOM	3/8 x E18	3,21
770/E3820-TOM	3/8 x E20	3,45
201/E10-PR	1/2 x E10	3,39
201/E11-PR	1/2 x E11	3,39
201/E12-PR	1/2 x E12	3,39
201/E14-PR	1/2 x E14	3,39
201/E16-PR	1/2 x E16	3,48
201/E18-PR	1/2 x E18	3,72
201/E20-PR	1/2 x E20	3,72
201/E22-PR	1/2 x E22	4,05
201/E24-PR	1/2 x E24	4,50



### Vasos de 1/2" de 12 lados

Refer:	mm	Precio €
17Z/10-ELO	10	4,58
17Z/12-ELO	12	4,58
17Z/21-ELO	21	4,80
17Z/22-ELO	22	4,80
17Z/24-ELO	24	5,10
17Z/27-ELO	27	5,47
17Z/30-ELO	30	6,90
17Z/32-ELO	32	6,90
17Z/36-ELO	36	16,40



### Adaptadores Hembra - Hembra

Refer:		Precio €
2610/1-ELO	De 3/4" a 1/2"	16,96
2610/3-ELO	De 3/4" a 1"	19,16



### Acoples Ampliadores y Reductores

Refer:	Hembra	Macho	Precio €
20601-PR	1/4"	3/8"	3,71
20602-PR	3/8"	1/4"	3,71
20603-PR	1/2"	3/8"	3,71
20604-PR	3/8"	1/2"	3,71
20605-PR	1/2"	3/4"	6,92
20606-PR	3/4"	1/2"	9,06
780/7-ELO	1"	3/4"	28,69



### Juego de Reducciones y Ampliaciones, 6 pzs.

Refer:		Precio €
206/6-PR	<div style="display: flex; flex-direction: column; gap: 5px;"> <div>Macho 1/4 a Hembra 3/8</div> <div>Macho 3/8 a Hembra 1/2</div> <div>Macho 1/2 a Hembra 3/4</div> <div>Macho 3/8 a Hembra 1/4</div> <div>Macho 1/2 a Hembra 3/8</div> <div>Macho 3/4 a Hembra 1/2</div> </div>	20,89



**Adaptadores Especiales para Puntas de 10 mm, 8 mm y 1/4"**

Refer:		Puntas de	Precio €
20628-PR	1/2"	1/4"	3,50
20621-PR	1/2"	8 mm	3,50
20620-PR	1/2"	10 mm	3,50
20625-PR	1/2"	14 mm	3,50
20622-PR	3/8"	10 mm	3,50
20623-PR	3/8"	8 mm	3,50



**Acoples Ampliadores y Reductores de Impacto**

Refer:		Hembra	Macho	Precio €
20609-PR		1/2"	3/4"	14,88
20610-PR		3/4"	1/2"	15,62
20611-PR		3/4"	1"	18,02
20612-PR		1"	3/4"	25,22



**Vasos 1/2" Impacto**

Refer:		Precio €
22000/K13	13	6,15
22000/K15	15	6,30
22000/K17	17	6,80
22000/K19	19	6,80
22000/K21	21	7,19
22000/K22	22	7,70
22000/K24	24	8,18

**1/2"**



**Vasos 1/2" Impacto Largos**

Refer:		Precio €
22099/K13	13	9,20
22099/K15	15	9,40
22099/K17	17	9,67
22099/K19	19	9,67
22099/K21	21	9,90
22099/K22	22	11,50
22099/K24	24	13,63



**Alargadera 1/2" Impacto**

Refer:			Precio €
197/125-PR	1/2	125 mm	11,72

**1/2"**

**Vaso Inyectores "Elora"**
**Refer:**
**775/L1-ELO**

Para Opel Corsa 1.5 L y V.W.

Polo 1.3L cogida de 1/2

Fabricado en C.V. (50CrV4)

**1/2x22x75 y salida de 12 lados.**
**Precio €**

36,08

**Vaso BiHexagonal 1/2 para inyectores gasoil**
**Refer:**
**770/LTD27-ELO**
**Medidas**

27 x 80 mm

**Precio €**

23,05

**Vaso Inyectores "Elora"**
**Refer:**
**775/L3-ELO**

Para motores TDI, Alfa Romeo, Jeep,

Rover, Opel Frontera, Scania y

Mann 6 cilindros D 0226.

Fabricado en CrMo. (42CrMo4)

**1/2x28x65 y salida de 12 lados.**
**Precio €**

53,52

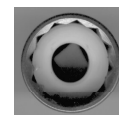
**Vaso Diferencial y Cigüeñales "Elora"**
**Refer:**
**775/L4-ELO**

Para cigüeñales, cajas de cambio
 y diferenciales.

Fabricado en C.V. (50CrV4)

**1/2x30x70 y salida de 12 lados.**
**Precio €**

49,78

**Vasos Inyectores "Elora"**
**Refer:**
**776/L1-ELO**

Para motores MB C y clase E Abags

Fabricado en C.V. (50CrV4)

**1/2"x22x110 y salida de 6 lados**
**Precio €**

43,11

**Vasos Inyectores "Elora"**
**Refer:**
**776/L2-ELO**

Para motores diesel XUD Citroen y

Peugeot tipo Euro II y Euro III.

Fabricado en CrMo. (42CrMo4)

**1/2x22x150 y salida de 6 lados.**
**Precio €**

53,45



**Vasos Inyectores "Elora"**

**Refer:** 776/L3-ELO **Precio €** 56,35

Para motores diesel XUD Citroen y Peugeot tipo Euro II y Euro III.  
Fabricado en CrMo. (42CrMo4)  
1/2x27x110 y salida de 6 lados.



**Vasos Sondas Lambda "Elora"**

**Refer:** 776/L4-ELO **Precio €** 39,88

Para Ford, Nissan, V.W. y Opel.  
Fabricado en CrMo. (42CrMo4)  
1/2x22x70 y salida de 6 lados.



**Vasos Sondas Lambda "Elora"**

**Refer:** 776/L5-ELO **Precio €** 44,74

Para Ford, Nissan, V.W. y Opel.  
Fabricado en CrMo. (42CrMo4)  
1/2x22x110 y salida de 6 lados.



**Vasos Sondas Lambda "Elora"**

**Refer:** 776/L7-ELO **Precio €** 47,86

Para Motores Mann D25 y D28.  
Mann Nr. 80.99603.0255  
Fabricado en CrMo. (42CrMo4)



**Adaptador para vasos de 1/2 con Luz**

**Refer:** 21909-PR **Precio €** 18,54

Hembra 1/2 x Macho 1/2 x 75 mm.

Incluye 3 pilas



**Adaptador Cuadradillo Macho**

<u>Refer:</u>	◐	↔	<u>Precio €</u>
1202VK-PR	1/2	38 mm	3,60



**Alargaderas de Carraca Flexibles**

<u>Refer:</u>	◐	↔	<u>Precio €</u>
3008557-TOP	1/4"	140 mm	6,16
21918-PR	1/2"	210 mm	26,22



**Alargaderas de Carraca**

<u>Refer:</u>	◐	↔	<u>Precio €</u>
203/50-PR	1/4"	50	1,26
203/14-PR	1/4"	75	1,50
203/100-PR	1/4"	100	1,80
205/75-PR	3/8"	75	3,12
205/150P-PR	3/8"	150	4,58
203/65-PR	1/2"	75	3,65
203-PR	1/2"	125	4,47
204-PR	1/2"	250	9,90
770/S3-PR	3/4"	100	17,22
770/S4-ELO	3/4"	200	20,15
770/S5-ELO	3/4"	400	39,79



**Manerales de Carraca**

<u>Refer:</u>	◐	↔	<u>Precio €</u>
202/14-PR	1/4"	115	3,97
202/250-PR	1/2"	250	11,13
770/34450-PR	3/4"	450	32,56



**Articulaciones Cardan**

<u>Refer:</u>	◐	↔	<u>Precio €</u>
205/14-PR	1/4"	38	3,57
205/12-PR	1/2"	72	8,26



Calidad: Cromo Vanadio

**Llaves Torx Planas de doble boca**

Refer:		Precio €
1001/1-PR	E 6 x E 8	6,09
1001/2-PR	E10 x E12	6,76
1001/3-PR	E14 x E18	7,83
1001/4-PR	E20 x E24	12,41

**Llaves Articuladas doble boca cerrada con 12 lados**

En Cromo Vanadio 31 CrV3

Refer:	 mm	Precio €	Refer:	 mm	Precio €
83825/1415-PAD	14 x 15	12,50	83825/2022-PAD	20 x 22	21,00
83825/1819-PAD	18 x 19	16,30	83825/2123-PAD	21 x 23	22,50



Para vasos y puntas de atornillador de 1/4"

**Llave Articulada de 1/4 Macho x 1/4 Hembra**

Refer:	Precio €
4440-PR	11,98

**Llaves Planas abiertas de doble boca para racores "Elora"**

Din 3118

Refer:	 mm	Precio €
121/1618-ELO	16 x 18	19,30



**Llaves Planas Fijas**

**Din 3110**

Refer:	mm	Precio €	Refer:	mm	Precio €
2/0607-TOM	6 x 7 x 130	1,72	2/2022-TOM	20 x 22 x 235	6,47
2/0809-TOM	8 x 9 x 140	1,88	2/2123-TOM	21 x 23 x 250	7,59
2/1011-TOM	10 x 11 x 156	2,11	2/2427-TOM	24 x 27 x 263	9,37
2/1213-TOM	12 x 13 x 172	2,57	2/2528-TOM	25 x 28 x 278	10,69
2/1415-TOM	14 x 15 x 190	3,28	2/3032-TOM	30 x 32 x 290	13,86
2/1617-TOM	16 x 17 x 202	3,83	2/3641-TOM	36 x 41 x 360	24,85
2/1819-TOM	18 x 19 x 220	4,51	2/5560-TOM	55 x 60 x 560	98,50



**Llaves de Tubo Huecas**

**Din 896 Forma B**

Refer:	mm	Precio €	Refer:	mm	Precio €
210/0607-TOM	6 x 7 x 105	2,53	210/2022-TOM	20 x 22 x 170	5,39
210/0809-TOM	8 x 9 x 105	2,71	210/2123-TOM	21 x 23 x 170	5,48
210/1011-TOM	10 x 11 x 120	2,88	210/2427-TOM	24 x 27 x 190	8,14
210/1213-TOM	12 x 13 x 140	3,22	210/2528-TOM	25 x 28 x 200	8,91
210/1415-TOM	14 x 15 x 140	3,41	210/3032-TOM	30 x 32 x 200	9,62
210/1617-TOM	16 x 17 x 150	4,27	210/3641-TOM	36 x 41 x 200	10,56
210/1819-TOM	18 x 19 x 160	5,31			



**Llaves de Tubo Macizas**

**Din 896 Forma A**

Refer:	mm	Precio €	Refer:	mm	Precio €
211/0607-TOM	6 x 7 x 105	3,95	211/1415-TOM	14 x 15 x 150	5,30
211/0809-TOM	8 x 9 x 110	4,32	211/1617-TOM	16 x 17 x 160	6,32
211/1011-TOM	10 x 11 x 130	4,59	211/1819-TOM	18 x 19 x 165	8,03
211/1213-TOM	12 x 13 x 140	5,14			



**Llaves de Pipa abiertas acodadas** Din 691

Refer:	mm	Precio €	Refer:	mm	Precio €
212/08-TOM	8 x 115	4,07	212/17-TOM	17 x 187	7,15
212/10-TOM	10 x 130	4,51	212/19-TOM	19 x 205	7,75
212/13-TOM	13 x 152	5,39			





**Llaves Mixtas Combinadas** Din 3113 For A

Refer:	mm	Precio €	Refer:	mm	Precio €
3/06-TOM	6 x 103	2,23	3/21-TOM	21 x 232	7,50
3/07-TOM	7 x 103	2,23	3/22-TOM	22 x 246	7,68
3/08-TOM	8 x 113	2,32	3/23-TOM	23 x 265	11,31
3/09-TOM	9 x 123	2,75	3/24-TOM	24 x 265	12,90
3/10-TOM	10 x 133	3,07	3/25-TOM	25 x 290	14,02
3/11-TOM	11 x 143	4,44	3/26-TOM	26 x 290	15,68
3/12-TOM	12 x 153	4,60	3/27-TOM	27 x 315	15,75
3/13-TOM	13 x 153	4,60	3/28-TOM	28 x 315	19,70
3/14-TOM	14 x 172	4,78	3/29-TOM	29 x 320	20,95
3/15-TOM	15 x 172	4,78	3/30-TOM	30 x 340	21,70
3/16-TOM	16 x 197	4,96	3/32-TOM	32 x 365	23,40
3/17-TOM	17 x 197	5,12	3/34-TOM	34 x 390	35,12
3/18-TOM	18 x 218	5,40	3/36-TOM	36 x 460	52,16
3/19-TOM	19 x 218	5,40	3/50-TOM	50 x 560	92,00
3/20-TOM	20 x 232	7,50			





**Llaves Acodadas de doble boca** Din 838

Refer:	mm	Precio €	Refer:	mm	Precio €
5/0607-TOM	6 x 7 x 130	3,57	5/2022-TOM	20 x 22 x 230	12,15
5/0809-TOM	8 x 9 x 145	3,95	5/2123-TOM	21 x 23 x 250	14,30
5/1011-TOM	10 x 11 x 160	4,59	5/2427-TOM	24 x 27 x 265	16,56
5/1213-TOM	12 x 13 x 175	5,24	5/2528-TOM	25 x 28 x 278	17,30
5/1415-TOM	14 x 15 x 190	6,60	5/3032-TOM	30 x 32 x 380	19,75
5/1617-TOM	16 x 17 x 202	8,15	5/3842-TOM	38 x 42 x 455	49,25
5/1819-TOM	18 x 19 x 220	8,92	5/3641-TOM	46 x 50 x 455	76,50

**Llaves Mixtas de Carraca**

Refer:	mm	Precio €	Refer:	mm	Precio €
4100/07-TOM	7	4,25	4100/18-TOM	18	9,80
4100/08-TOM	8	4,55	4100/19-TOM	19	10,50
4100/09-TOM	9	4,75	4100/20-TOM	20	15,33
4100/10-TOM	10	4,90	4100/21-TOM	21	16,92
4100/11-TOM	11	5,80	4100/22-TOM	22	17,64
4100/12-TOM	12	6,45	4100/23-TOM	23	19,08
4100/13-TOM	13	6,80	4100/24-TOM	24	20,61
4100/14-TOM	14	6,90	4100/25-TOM	25	24,09
4100/15-TOM	15	7,60	4100/27-TOM	27	26,43
4100/16-TOM	16	8,05	4100/30-TOM	30	30,90
4100/17-TOM	17	8,85	4100/32-PR	32	41,80

**Llaves Mixtas de Carraca Articuladas**

Refer:	mm	Precio €	Refer:	mm	Precio €
4106/08-PR	8	11,68	4106/17-TOM	17	20,47
4106/09-PR	9	12,19	4106/18-PR	18	21,93
4106/10-TOM	10	12,25	4106/19-TOM	19	23,08
4106/11-PR	11	12,63	4106/20-PR	20	23,27
4106/12-PR	12	12,72	4106/21-PR	21	24,28
4106/13-TOM	13	14,71	4106/22-PR	22	24,78
4106/14-PR	14	15,81	4106/23-PR	23	25,30
4106/15-PR	15	17,19	4106/24-PR	24	26,55
4106/16-PR	16	19,30	4106/26-PR	26	29,00

**Juegos de LLaves Planas**

<b>Refer:</b>		<b>Precio €</b>
<b>25/08T-TOM</b>	8 piezas	15,80

Nros: 6x7, 8x9, 10x11, 12x13, 14x15, 16x17, 18x19 y 20x22

<b>Refer:</b>		<b>Precio €</b>
<b>25/12T-TOM</b>	12 piezas	41,17

Nros: 6x7, 8x9, 10x11, 12x13, 14x15, 16x17, 18x19, 20x22, 21x23, 24x27, 25x28 y 30x32

**Juegos de LLaves Acodadas**

<b>Refer:</b>		<b>Precio €</b>
<b>10/08T-TOM</b>	8 piezas	23,38

Nros: 6x7, 8x9, 10x11, 12x13, 14x15, 16x17, 18x19 y 20x22

<b>Refer:</b>		<b>Precio €</b>
<b>10/12T-TOM</b>	12 piezas	45,57

Nros: 6x7, 8x9, 10x11, 12x13, 14x15, 16x17, 18x19, 20x22, 21x23, 24x27, 25x28 y 30x32

**Juegos de LLaves Mixtas**

<b>Refer:</b>		<b>Precio €</b>
<b>35/08T-TOM</b>	8 piezas	11,26

Nros: 6, 8, 10, 11, 13, 14, 17 y 19

<b>Refer:</b>		<b>Precio €</b>
<b>35/12T-TOM</b>	12 piezas	18,90

Nros: 6, 7, 8, 9, 10, 11, 12, 13, 14, 17, 19 y 22

**Juego Llaves Tubo Huecas**

<b>Refer:</b>		<b>Precio €</b>
<b>125-PR</b>	9 piezas	19,55

Nros: 6x7, 8x9, 10x11, 12x13, 14x15, 16x17, 18x19 y 20x22

1 Barra de apriete



**Juego Llaves Tubo Macizas**

<b>Refer:</b>		<b>Precio €</b>
<b>211-TOM</b>	7 piezas	29,75

Nros: 6x7, 8x9, 10x11, 12x13, 14x15 y 16x17

1 Barra de apriete

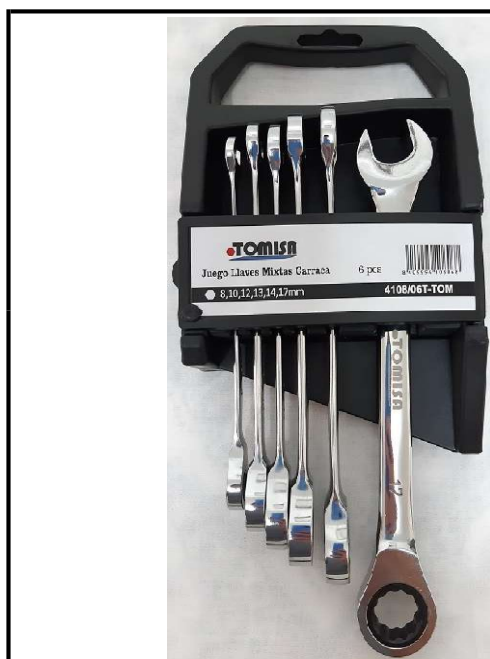

**Juego Llaves Mixtas de Carraca**

<b>Refer:</b>		<b>Precio €</b>
<b>4108/06T-TOM</b>	6 piezas	34,21

Nros: 8, 10, 12, 13, 14 y 17

Sobre soporte de plástico con asa

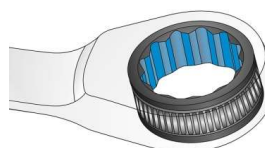

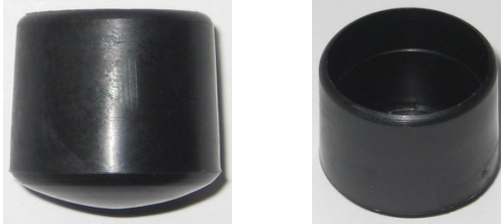

**Conteras Redondas Exteriores (100 uds)**

Refer:	Medida	Color	Precio €
NS/06N-MK	6 mm	N	3,75
NS/08N-MK	8 mm	B / N	4,22
NS/10N-MK	10 mm	B / N	4,90
NS/12N-MK	12 mm	B / N	5,08
NS/14N-MK	14 mm	B / N	5,74
NS/16N-MK	16 mm	B / N	6,22
NS/18N-MK	18 mm	B / N	6,89
NS/20N-MK	20 mm	B / N	7,77
NS/22N-MK	22 mm	B / N	8,86
NS/25N-MK	25 mm	B / N	9,54
NS/28N-MK	28 mm	B / N	12,22
NS/30N-MK	30 mm	B / N	17,72
NS/32N-MK	32 mm	B / N	19,54
NS/35N-MK	35 mm	B / N	21,97
NS/40N-MK	40 mm	B / N	28,19
NS/45N-MK	45 mm	B / N	51,49
NS/50N-MK	50 mm	B / N	61,87
NS/60N-MK	60 mm	N	86,98

**Conteras Redondas Interiores (100 uds)**

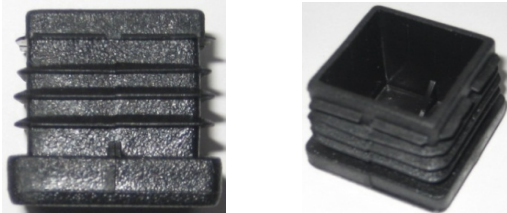
Refer:	Medida	Color	Precio €
STRIP/12N-MK	12 mm	N	5,32
STRIP/14N-MK	14 mm	N	6,22
STRIP/16N-MK	16 mm	B / N	6,43
STRIP/18N-MK	18 mm	B / N	7,09
STRIP/20N-MK	20 mm	B / N	7,48
STRIP/22N-MK	22 mm	B / N	8,19
STRIP/25N-MK	25 mm	B / N	9,38
STRIP/28N-MK	28 mm	B / N	10,47
STRIP/30N-MK	30 mm	B / N	11,83
STRIP/32N-MK	32 mm	B / N	14,57
STRIP/35N-MK	35 mm	B / N	18,38
STRIP/38N-MK	38 mm	B / N	21,97
STRIP/40N-MK	40 mm	B / N	25,30
STRIP/45N-MK	45 mm	B / N	28,72
STRIP/50N-MK	50 mm	B / N	32,34
STRIP/60N-MK	60 mm	B / N	35,60
STRIP/70N-MK	70 mm	N	50 uds 47,62
STRIP/80N-MK	80 mm	B / N	50 uds 44,17
STRIP/90N-MK	90 mm	N	50 uds 81,21
STRIP/100N-MK	100 mm	B / N	25 uds 65,62
STRIP/120N-MK	120 mm	N	25 uds 70,89

**Conteras Cuadradas Interiores (100 uds)**

Refer:	Medida	Color	Precio €
STRK/10N-MK	10 mm	N	5,48
STRK/12N-MK	12 mm	N	5,80
STRK/14N-MK	14 mm	B / N	6,11
STRK/16N-MK	16 mm	B / N	7,22
KEXT/16N-MK	16 mm	N exterior	13,72
STRK/18N-MK	18 mm	B / N	7,64
STRK/20N-MK	20 mm	B / N	8,03
KEXT/20N-MK	20 mm	N exterior	15,36
STRK/22N-MK	22 mm	B / N	9,57
STRK/25N-MK	25 mm	B / N	9,99
KEXT/25N-MK	25 mm	N exterior	16,42
STRK/30N-MK	30 mm	B / N	13,80
KEXT/30N-MK	30 mm	N exterior	17,54
STRK/35N-MK	35 mm	B / N	15,03
STRK/40N-MK	40 mm	B / N	21,58
STRK/45N-MK	45 mm	B / N	31,44
STRK/50N-MK	50 mm	B / N	26,20
STRK/60N-MK	60 mm	B / N	28,38
STRK/70N-MK	70 mm	B / N	50 uds 100,45
STRK/80NC-MK	80 mm	B / N	50 uds 55,18
STRK/90N-MK	90 mm	N	50 uds 106,96
STRK/100NA-MK	100 mm	B / N	25 uds 62,99
STRK/120NA-MK	120 mm	N	20 uds 61,80

**Conteras Rectangulares Interiores (100 uds)**

Refer:	Medida	Color	Precio €
STRKK/2010N-MK	20 x 10 mm	N	7,13
STRKK/2015N-MK	20 x 15 mm	N	7,86
STRKK/2510N-MK	25 x 10 mm	N	9,42
STRKK/2515N-MK	25 x 15 mm	N	8,50
STRKK/3010N-MK	30 x 10 mm	N	8,86
STRKK/3015N-MK	30 x 15 mm	B / N	9,57
STRKK/3020N-MK	30 x 20 mm	B / N	10,05
STRKK/3025N-MK	30 x 25 mm	N	11,82
STRKK/3515N-MK	35 x 15 mm	N	10,93
STRKK/3520N-MK	35 x 20 mm	B / N	12,01
STRKK/3525N-MK	35 x 25 mm	N	17,45
STRKK/4010N-MK	40 x 10 mm	B / N	11,44
STRKK/4015N-MK	40 x 15 mm	N	11,50
STRKK/4020N-MK	40 x 20 mm	B / N	15,72
STRKK/4025N-MK	40 x 25 mm	N	16,39
STRKK/4030N-MK	40 x 30 mm	B / N	17,48

STRKK/5010N-MK	50 x 10 mm	N	23,63
STRKK/5015N-MK	50 x 15 mm	N	15,57
STRKK/5020N-MK	50 x 20 mm	B / N	17,35
STRKK/5025N-MK	50 x 25 mm	N	19,15
STRKK/5030N-MK	50 x 30 mm	N	21,99
STRKK/5040N-MK	50 x 40 mm	N	39,04
STRKK/6010N-MK	60 x 10 mm	N	18,53
STRKK/6020N-MK	60 x 20 mm	B / N	27,70
STRKK/6030N-MK	60 x 30 mm	B / N	21,66
STRKK/6040N-MK	60 x 40 mm	B / N	30,44
STRKK/7020B-MK	70 x 20 mm	B / N 50 uds	19,02
STRKK/7030N-MK	70 x 30 mm	N 50 uds	19,46
STRKK/7040N-MK	70 x 40 mm	B / N 50 uds	25,22
STRKK/7050N-MK	70 x 50 mm	N	54,93
STRKK/8020N-MK	80 x 20 mm	B / N	36,99
STRKK/8030N-MK	80 x 30 mm	N 50 uds	19,62
STRKK/8040N-MK	80 x 40 mm	B / N	27,27
STRKK/8060N-MK	80 x 60 mm	N 50 uds	31,34
STRKK/10020N-MK	100 x 20 mm	B / N 25 uds	17,05
STRKK/10030N-MK	100 x 30 mm	N 50 uds	41,88
STRKK/10040N-MK	100 x 40 mm	B / N 50 uds	60,20
STRKK/10050N-MK	100 x 50 mm	B / N 50 uds	67,19
STRKK/10060N-MK	100 x 60 mm	N 50 uds	57,44
STRKK/12040N-MK	120 x 40 mm	N 25 uds	70,76
STRKK/12060N-MK	120 x 60 mm	N 25 uds	73,45
STRKK/15050N-MK	150 x 50 mm	N 25 uds	80,19

**Topes de puerta Atornillables (100 uds)**

Refer:	Ø	Color	Precio €
TP/1BB-MK	26 mm	Blanco	13,49

**Soportes y Casquillos para baldas (100 uds)**

Refer:	Medida	Modelo	Precio €
MS/1N-MK	8 mm	Soporte Negro	4,43
MS2/ANGB-MK	6 mm	Soporte Blanco	2,19
MS2/CASN-MK	6-8mm	Casquillo Marrón	2,48
MS2/CASB-MK	6-8mm	Casquillo Blanco	2,48

**Tapón para Tornillos Pz-2 (1000 uds)**

Refer:	Ø	Color	Precio €
8913N-TOM	13 mm	Negro	16,80
8913R-TOM	13 mm	Roble	16,80

**Tapón para Tornillos 4,8 mm (500 uds)**

Refer:	Ø	Color	Precio €
94TN	11,5 mm	Negro	19,56
91TB	11,5 mm	Blanco	19,56

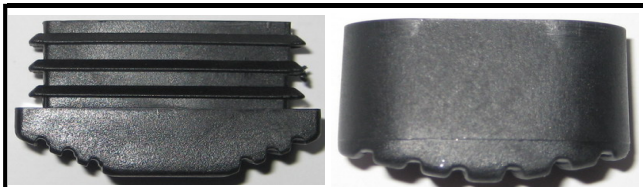
**Conteras para Escaleras (100 uds)**

Refer:	Medida	Modelo	Precio €
E418/N-MK	40 x 20 mm	Exterior	19,53
E455/N-MK	50 x 20 mm	Interior	29,26

**Tacos Cuadrados Interiores (25 uds)**

Refer:	Medida	Métrica	Precio €
E474/M10N-MK	30 mm	M-10	13,56
E474/35N-MK	35 mm	M-10	13,92
E457/M10N-MK	40 mm	M-10	14,79
E457/50N-MK	50 mm	M-10	27,17

**Cantoneras en Angulo (100 uds)**

Refer:	Medida	Modelo	Precio €
E360/N-MK	35 mm	Exterior	9,30
E417/N-MK	40 mm	Exterior	11,77

**Conteras Ovaladas Interiores (100 uds)**

Refer:	Pared	Medida	Precio €
STRFLEX/30N-MK	Estriada	30 x 15 mm	16,00
FLEX/3515N-MK	Lisa	35 x 15 mm	16,00

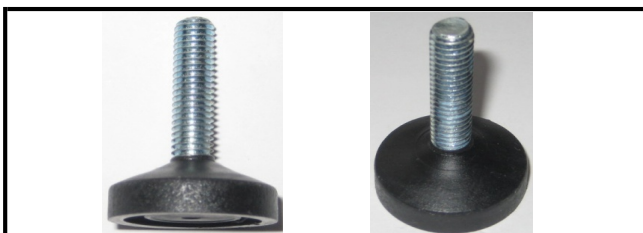
**Patas Niveladoras (25 uds)**

Refer:	Base	Tornillo	Precio €
PR30/M840N-MK	30 mm	M-8 x 30 mm	17,41
PR30/M104N-MK	30 mm	M-10 x 30 mm	17,41
PR42/M104N-MK	42 mm	M-10 x 30 mm	17,41
E148/M10N-MK	52 mm	M-10 x 30 mm	21,40
E148/M12N-MK	52 mm	M-12 x 30 mm	21,81

**Pomos Reguladores (25 uds)**

Refer:	Base	Tornillo	Precio €
PM/6N-MK	30 mm	M-6 x 20 mm	13,12
PM/8N-MK	30 mm	M-8 x 20 mm	14,36
PMG/8N-MK	30 mm	M-8 x 25 mm	17,13
PM/10N-MK	30 mm	M-10 x 25 mm	17,98
PMG/10N-MK	40 mm	M-10 x 30 mm	18,90

**Tapatuercas de Plástico (100 uds)**

Refer:	Medida	Color	Precio €
E407/AB-MK	M-6	Blanco	9,65
E407/AN-MK	M-6	Negro	9,65
E471/B-MK	M-8	Blanco	10,58
E471/N-MK	M-8	Negro	10,58
E433/B-MK	M-10	Blanco	14,81
E433/N-MK	M-10	Negro	14,81
E434/B-MK	M-12	Blanco	23,25
E434/N-MK	M-12	Negro	23,25
E436/B-MK	M-16	Blanco	25,26
E436/N-MK	M-16	Negro	25,26

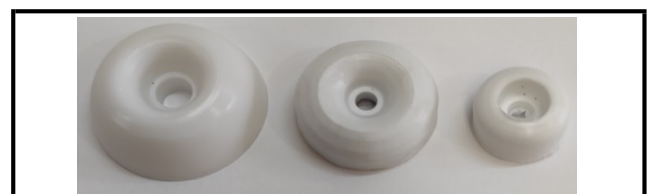
**Topes Cilíndricos de Plástico (100 uds)**

Refer:	Medida	Precio €
WC/00B-MK	12 mm	5,18
WC/0B-MK	19 mm	5,33
WC/1B-MK	23 mm	5,49



**Conteras Goma Andador Alta (50 uds)**

Refer:	Medida	Color	Precio €
88413/N-CC	25 mm	Negro	25,80
88413/G-CC	25 mm	Gris	38,25



**Conteras Goma Muleta Alta (50 uds)**

Refer:	Medida	Color	Precio €
88417-CC	17 mm	Negro	46,61
88419-CC	19 mm	Negro	46,61
88421-CC	21 mm	Negro	46,61



**Conteras Goma Redonda (50 uds)**

Refer:	Medida	Color	Precio €
88411/10-CC	10 mm	Negro	10,77
88411/12-CC	12 mm	Negro	10,85
88411/14-CC	14 mm	Negro	12,25
88411/16-CC	16 mm	Negro	14,57
88411/18-CC	18 mm	Negro	15,65
88411/20-CC	20 mm	Negro	16,43
88411/22-CC	22 mm	Negro	16,90
88411/25-CC	25 mm	Negro	18,76
88411/28-CC	28 mm	Negro	28,05
88411/30-CC	30 mm	Negro	29,40
88411/35-CC	35 mm	Negro	30,15
88411/38-CC	38 mm	Negro	31,50

## **CONDICIONES GENERALES DE VENTA**

---

### **Objeto y Vigencia**

Las condiciones generales de venta y prestación de servicios regula las transacciones comerciales entre Tomisa Herramientas, S.L. y el cliente, donde la primera vende y la segunda compra materiales comercializados por Tomisa.

Las presentes condiciones generales entran en vigor el día de apertura de ficha del cliente, y prevalece sobre cualquier condición general del cliente, salvo acuerdo escrito.

### **Precio**

Los precios de las mercancías adquiridas por el cliente son los que se encuentran en vigor el día del pedido, denominados en Euros, a los que añadir el impuesto legal en vigor y gastos de transporte aplicables en el momento de la formalización del pedido.

Los precios que aparecen en la tarifa Tomisa están sujetos a alteraciones por circunstancias del mercado sin previo aviso.

### **Forma de Pago**

Los pagos podrán ser realizados por el cliente mediante transferencia bancaria contra factura proforma con descuento financiero del 2%.

Después del primer pedido, los pagos podrán ser realizados mediante giro domiciliado a 30 o 60 días fecha factura, en función del valor de la mercancía.

### **Transporte y Entregas**

Los pedidos serán despachados por cuenta de nuestra agencia de transporte, salvo en los casos que el cliente envíe a su propia agencia a relizar la recogida, corriendo en este caso a su cuenta.

Los pedidos superiores a 150 € serán entregados a portes pagados.

Para pedidos inferiores a 150 €, se cargarán 5 € en concepto de portes en factura.

### **Reclamaciones y Devoluciones**

El cliente tiene derecho a devolución previa reclamación por escrito, debidamente fundamentada y acompañada de copia de factura. No se admitirán reclamaciones ni devoluciones pasados 15 días.