



**TOMISA**

# Catálogo Tarifa 2025



[www.tomisadistribucion.com](http://www.tomisadistribucion.com)

## Índice General Catálogo

- ➔ Fijaciones 
- ➔ Brocas 
- ➔ Discos 
- ➔ Productos Químicos 
- ➔ Bridas y Complementos 
- ➔ Puntas y Adaptadores 
- ➔ Tornillería 
- ➔ Destornilladores 
- ➔ Soldadores y Cepillos 
- ➔ Coronas y Hojas de Corte 
- ➔ Protección 
- ➔ Artículos Diversos 
- ➔ Alicates y Mordazas 
- ➔ Herramientas de Corte 
- ➔ Material Eléctrico 
- ➔ Herramientas de Mano 
- ➔ Llaves de Vaso y Mano 
- ➔ Conteras 

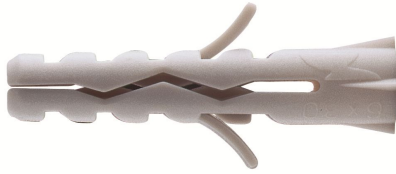
**Tacos de Nylon en Cajas**

| <u>Refer:</u> | <u>Medida</u> |     |      | <u>Precio €</u><br><u>Caja</u> |
|---------------|---------------|-----|------|--------------------------------|
| 1011322-TEX   | 5x25          | 200 | 6400 | 4,99                           |
| 1011335-TEX   | 6x30          | 200 | 6400 | 5,39                           |
| 1011345-TEX   | 7x30          | 100 | 4800 | 5,63                           |
| 1011355-TEX   | 8x40          | 100 | 4800 | 4,55                           |
| 1011365-TEX   | 10x50         | 50  | 1000 | 3,32                           |
| 1011375-TEX   | 12x60         | 25  | 900  | 2,98                           |
| 1011381-TEX   | 14x80         | 25  | 250  | 4,69                           |

**Tacos de Nylon con Cuello en Cajas**



| <u>Refer:</u> | <u>Medida</u> |     |      | <u>Precio €</u><br><u>Caja</u> |
|---------------|---------------|-----|------|--------------------------------|
| 1011335/C-TEX | 6x30          | 200 | 6400 | 5,39                           |
| 1011356/C-TEX | 8x40          | 100 | 4800 | 4,55                           |
| 1011366/C-TEX | 10x50         | 50  | 1000 | 3,32                           |

**Taco Nylon Universal GX**

| <u>Refer:</u> | <u>Medida</u> |     |      | <u>Precio €</u><br><u>Caja</u> |
|---------------|---------------|-----|------|--------------------------------|
| 10150525-TOM  | 5x25          | 200 | 4000 | 5,74                           |
| 10150630-TOM  | 6x30          | 200 | 6400 | 5,74                           |
| 10150840-TOM  | 8x40          | 150 | 2400 | 8,49                           |
| 10151050-TOM  | 10x50         | 75  | 1200 | 7,80                           |
| 10151260-TOM  | 12x60         | 25  | 400  | 4,76                           |
| 10151470-TOM  | 14x70         | 25  | 400  | 6,31                           |

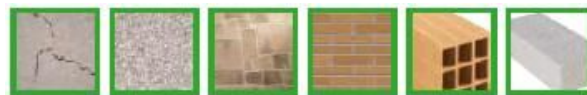

| <u>Refer:</u> | <u>Medida</u> |      |      | <u>Precio €</u><br><u>Bolsa</u> |
|---------------|---------------|------|------|---------------------------------|
| 10150525B-TOM | 5x25          | 1000 | 5000 | 24,65                           |
| 10150630B-TOM | 6x30          | 1000 | 5000 | 24,36                           |
| 10150840B-TOM | 8x40          | 500  | 2500 | 23,78                           |
| 10151050B-TOM | 10x50         | 250  | 1250 | 22,11                           |
| 10151260B-TOM | 12x60         | 125  | 625  | 17,69                           |

**Conjunto Fijación Tacos + Alcayatas**

| <u>Refer:</u> | <u>Medida Taco</u> | <u>Medida Alcayata</u> |    | <u>Precio €</u><br><u>Blisters</u> |
|---------------|--------------------|------------------------|----|------------------------------------|
| HSF410-TOM    | 10x50              | 8x65                   | 50 | 1,10                               |
| HSF412-TOM    | 12x60              | 10x75                  | 50 | 2,06                               |

Ideal para la fijación de calentadores y medias cargas.

Compuesto por 2 Tacos GX + 2 Alcayatas (4 piezas).



**Tacos de NYLON con tornillo POZY**



| <u>Refer:</u> | <u>Medida</u> |             | <u>Precio €</u> |
|---------------|---------------|-------------|-----------------|
|               |               | <u>Caja</u> |                 |
| 8722004-ELM   | 8x60          | 50          | 9,16            |
| 8722008-ELM   | 10x100        | 25          | 9,80            |
| 8722009-ELM   | 10x115        | 20          | 9,18            |



**Tacos de NYLON con tornillo HEX**

| <u>Refer:</u> | <u>Medida</u> |             | <u>Precio €</u> |
|---------------|---------------|-------------|-----------------|
|               |               | <u>Caja</u> |                 |
| 8722025-ELM   | 8x80          | 50          | 10,25           |
| 8722029-ELM   | 10x115        | 20          | 9,10            |

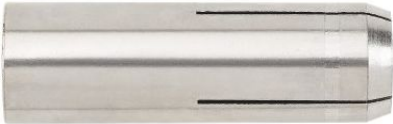
**Tacos de nylon con tornillo a GOLPE**



| <u>Refer:</u> | <u>Taco</u> | <u>Cabeza</u> |             | <u>Precio €</u> |
|---------------|-------------|---------------|-------------|-----------------|
|               |             |               | <u>Caja</u> |                 |
| 8793026-TOM   | 5x35        | Cónica        | 100         | 7,00            |
| 8793029-TOM   | 6x40        | Cónica        | 100         | 8,25            |
| 8793030-TOM   | 6x55        | Cónica        | 100         | 9,60            |
| 8793034-TOM   | 8x60        | Cónica        | 100         | 16,38           |
| 8793035-TOM   | 8x75        | Cónica        | 100         | 20,67           |
| 8793036-TOM   | 8x100       | Cónica        | 50          | 13,57           |
| 8793037-TOM   | 8x120       | Cónica        | 50          | 15,62           |

|  | Tacos de ACERO para retacar |          |          |  | Precio € |
|---|-----------------------------|----------|----------|---|----------|
|   | Refer:                      | Exterior | Interior |   | Caja     |
|   | 8735131-TEX                 | 8 x 30   | M-6      | 100   | 10,45    |
|   | 8735141-TEX                 | 10 x 30  | M-8      | 100   | 15,63    |
|   | 8735151-TEX                 | 12 x 40  | M-10     | 50  | 17,81    |

|  | Tacos de LATON para expansión |          |          |  | Precio € |
|---|-------------------------------|----------|----------|---|----------|
|   | Refer:                        | Exterior | Interior |   | Caja     |
|   | 8725001-FRA                   | 5 x 20   | M-4      | 700   | 63,64    |
|   | 8725002-FRA                   | 6.5 x 21 | M-5      | 350   | 34,86    |
|   | 8725003/2-FRA                 | 8 x 24   | M-6      | 200   | 31,62    |
|   | 8725004/3-TEX                 | 10 x 30  | M-8      | 150   | 50,27    |
|   | 8725005-FRA                   | 12 x 35  | M-10     | 100   | 46,05    |
|   | 8725008FRA                    | 15 x 40  | M-12     | 50  | 44,17    |

|  | Tacos METALICOS con tornillo |        |  |  | Precio € |
|---|------------------------------|--------|--|---|----------|
|   | Refer:                       | Taco   |  |   | Caja     |
|   | 60860-VO                     | 10x75  |  | 50  | 19,58    |
|   | 60865-VO                     | 10x90  |  | 50  | 19,11    |
|   | 60870-VO                     | 10x110 |  | 50  | 22,13    |



| Taco Pladur tipo Aletas |        |   | Precio € |
|-------------------------|--------|---|----------|
| Refer:                  | Medida |  | Caja     |
| 8711912-TOM             | 10x33  | 100   | 7,25     |



| Taco Roscado Plástico |        |   | Precio € |
|-----------------------|--------|---|----------|
| Refer:                | Medida |  | Caja     |
| 8742309-TOM           | 11x30  | 100   | 6,52     |



| Taco Metálico Pladur cincado |       |          |   | Precio € |
|------------------------------|-------|----------|---|----------|
| Refer:                       | Taco  | Tornillo |  | Caja     |
| 48011-GB                     | 8x40  | M4x46    | 200   | 41,04    |
| 48063-GB                     | 10x50 | M5x65    | 100   | 32,56    |



| Alicate para Tacos Metálicos Pladur |  | Precio € |
|-------------------------------------|--|----------|
| Refer:                              |  |          |
| TK30-GB                             |   | 17,64    |



Cierre con Doble Tornillo

| <b>Abrazaderas Metálicas Ligeras M-6</b> |                |          |     | <b>Precio €</b> |
|--|----------------|----------|-----|-----------------|
| <u>Refer:</u>                            | <u>Acabado</u> | <u>Ø</u> |     | <u>Caja</u>     |
| 125/0612-DE                              | Bicromatado    | 12 mm    | 100 | 18,63           |
| 125/0614-DE                              | "              | 14 mm    | 100 | 19,20           |
| 125/0615-DE                              | "              | 15 mm    | 100 | 19,38           |
| 125/0618-DE                              | "              | 18 mm    | 100 | 20,70           |
| 125/0620-DE                              | "              | 20 mm    | 100 | 20,91           |
| 125/0622-DE                              | "              | 22 mm    | 100 | 21,48           |
| 125/0625-DE                              | "              | 25 mm    | 100 | 22,59           |
| 125/0628-DE                              | "              | 28 mm    | 100 | 23,94           |
| 125/0632-DE                              | "              | 32 mm    | 50  | 13,33           |
| 125/0640-DE                              | "              | 40 mm    | 50  | 16,78           |
| 125/0650-DE                              | "              | 50 mm    | 50  | 21,04           |
| 125/0663-DE                              | "              | 63 mm    | 50  | 25,35           |
| 125/0612N-DE                             | Niquelado      | 12 mm    | 100 | 24,61           |



| <b>Tornillo para abrazaderas Metálicas</b> |               |     |             | <b>Precio €</b> |
|--|---------------|-----|-------------|-----------------|
| <u>Refer:</u>                              | <u>Medida</u> |     | <u>Caja</u> |                 |
| 650630/B-DE                                | M-6x30x5      | 100 |             | 4,37            |
| 650640/B-DE                                | M-6x40x5      | 100 |             | 5,84            |
| 650650/B-DE                                | M-6x50x5      | 100 |             | 6,92            |
| 650840/B-NOR                               | M-8x40x9      | 100 |             | 8,70            |



| <b>Abrazaderas Isofónicas M-6</b> |          |     |             | <b>Precio €</b> |
|-----------------------------------|----------|-----|-------------|-----------------|
| <u>Refer:</u>                     | <u>Ø</u> |     | <u>Caja</u> |                 |
| 126/0615B-DE                      | 15 mm    | 100 |             | 28,17           |
| 126/0618B-DE                      | 18 mm    | 100 |             | 29,51           |
| 126/0622B-DE                      | 22 mm    | 100 |             | 32,02           |
| 126/0625B-DE                      | 26 mm    | 100 |             | 36,22           |
| 126/0632B-DE                      | 32 mm    | 50  |             | 20,79           |



| <b>Abrazaderas Metálicas de Dos Patas</b> |          |     |             | <b>Precio €</b> |
|---|----------|-----|-------------|-----------------|
| <u>Refer:</u>                             | <u>Ø</u> |     | <u>Caja</u> |                 |
| 128/08Z-DE                                | 8 mm     | 100 |             | 9,10            |
| 128/10Z-DE                                | 10 mm    | 100 |             | 9,69            |
| 128/12Z-DE                                | 12 mm    | 100 |             | 10,15           |
| 128/15Z-DE                                | 15 mm    | 100 |             | 11,34           |
| 128/18Z-DE                                | 18 mm    | 100 |             | 15,36           |
| 128/20Z-DE                                | 20 mm    | 100 |             | 16,55           |
| 128/22Z-DE                                | 22 mm    | 100 |             | 17,29           |
| 128/25Z-DE                                | 25 mm    | 100 |             | 18,13           |
| 128/28Z-DE                                | 28 mm    | 100 |             | 19,53           |
| 128/32Z-DE                                | 32 mm    | 100 |             | 23,24           |
| 128/40Z-DE                                | 40 mm    | 50  |             | 13,12           |
| 128/50Z-DE                                | 50 mm    | 50  |             | 19,30           |



| <b>Abrazaderas Metálicas Una Pata</b> |          |     |             | <b>Precio €</b> |
|---------------------------------------|----------|-----|-------------|-----------------|
| <u>Refer:</u>                         | <u>Ø</u> |     | <u>Caja</u> |                 |
| 127/08Z-DE                            | 8 mm     | 100 |             | 5,05            |
| 127/10Z-DE                            | 10 mm    | 100 |             | 6,04            |
| 127/12Z-DE                            | 12 mm    | 100 |             | 7,09            |
| 127/15Z-DE                            | 15 mm    | 100 |             | 7,89            |
| 127/18Z-DE                            | 18 mm    | 100 |             | 11,22           |
| 127/20Z-DE                            | 20 mm    | 100 |             | 11,65           |
| 127/22Z-DE                            | 22 mm    | 100 |             | 12,44           |
| 127/25Z-DE                            | 25 mm    | 100 |             | 13,86           |
| 127/28Z-DE                            | 28 mm    | 100 |             | 15,94           |
| 127/32Z-DE                            | 32 mm    | 50  |             | 9,59            |
| 127/40Z-DE                            | 40 mm    | 50  |             | 12,77           |
| 127/50Z-DE                            | 50 mm    | 50  |             | 18,63           |



**Tornillos para WC y Bidet Laterales**

| Refer:    | Taco | Tornillo  |     | Precio €     |
|-----------|------|-----------|-----|--------------|
|           |      |           |     | <u>Bolsa</u> |
| 871422-DE | 8x40 | 5x70 Zinc | 100 | 1,73         |



**Tornillos para Lavabo**

| Refer:      | Taco  | Tornillo       |    | Precio €     |
|-------------|-------|----------------|----|--------------|
|             |       |                |    | <u>Bolsa</u> |
| 8714302-ELM | 12x60 | 10x110 Zincado | 50 | 1,61         |



**Tornillos para WC y Bidet**

| Refer:    | Taco | Tornillo  |     | Precio €     |
|-----------|------|-----------|-----|--------------|
|           |      |           |     | <u>Bolsa</u> |
| 871421-DE | 8x40 | 6x75 Inox | 100 | 1,83         |
| 871420-DE | 8x40 | 6x75 Zinc | 100 | 0,92         |



**Tornillos para WC y Bidet con Escuadra**

| Refer:    | Taco  | Tornillo       |    | Precio €     |
|-----------|-------|----------------|----|--------------|
|           |       |                |    | <u>Bolsa</u> |
| 871423-DE | 10x50 | 10x110 Zincado | 40 | 4,20         |

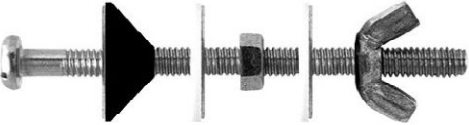

**Tornillos para WC Taza-Tanque**

| Refer:    | Tornillo  |     | Precio €     |
|-----------|-----------|-----|--------------|
|           |           |     | <u>Bolsa</u> |
| 871424-DE | 6x90 Inox | 100 | 2,12         |



**DIN 9021**

**Arandelas de Ala Ancha Zincadas**

| Refer:         | Ø    |      | Precio €    |
|----------------|------|------|-------------|
|                |      |      | <u>Caja</u> |
| 709021/04-TOM  | M-4  | 1000 | 7,32        |
| 709021/05-TOM  | M-5  | 1000 | 15,29       |
| 709021/06-TOM  | M-6  | 1000 | 24,42       |
| 709021/08-TOM  | M-8  | 500  | 30,74       |
| 709021/10-TOM  | M-10 | 250  | 25,70       |
| 709021/12D-TOM | M-12 | 200  | 37,45       |
| 709021/14D-TOM | M-14 | 200  | 42,27       |
| 709021/16-TOM  | M-16 | 100  | 32,76       |
| 709021/18-TOM  | M-18 | 50   | 25,20       |
| 709021/20-TOM  | M-20 | 50   | 38,14       |



**Cinta Perforada Galvanizada**

| Refer:       |                      | Precio € |
|--------------|----------------------|----------|
| 124/1708-NOR | 10mts x 17mm x 0,8mm | 6,24     |



**DIN 6334**

| Refer:      | Medida    |     | Precio €    |
|-------------|-----------|-----|-------------|
|             |           |     | <u>Caja</u> |
| 8736920-TEX | M-5 x 15  | 100 | 10,04       |
| 8736921-TEX | M-6 x 20  | 100 | 10,96       |
| 8736931-TEX | M-8 x 25  | 50  | 8,95        |
| 8736941-TEX | M-10 x 30 | 50  | 18,88       |
| 8736951-TEX | M-12 x 35 | 50  | 26,61       |





**Taco IZO para Paneles Aislantes**

| Refer:      | Medida  |     | Precio €<br>Caja |
|-------------|---------|-----|------------------|
| 8753521-TEX | 10 x 70 | 200 | 24,18            |
| 8753522-TEX | 10 x 90 | 200 | 29,75            |

Indicado para fijación de paneles aislantes blandos o rígidos resistentes a la compresión. Lana de vidrio, poliestirol, corcho...



**Cánula para cartuchos Silicona**

| Refer:    |    | Precio €<br>Caja |
|-----------|----|------------------|
| 34280-TOM | 24 | 3,85             |



**Cánula para Espuma Poliuretano**

| Refer:       |    | Precio €<br>Caja |
|--------------|----|------------------|
| 10C21012-TOM | 10 | 6,90             |



**Cánula Mezcladora Taco Químico**

| Refer:     | Medida |    | Precio €<br>Bolsa |
|------------|--------|----|-------------------|
| 10CM12-TOM | M-17   | 12 | 3,95              |

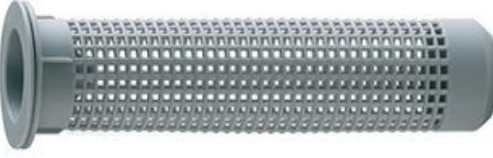

**Tamices de Nylon para Taco Químico**

| Refer:      | Varilla | Medida                |    | Precio €<br>Bolsa |
|-------------|---------|-----------------------|----|-------------------|
| 10CB08-TOM  | M-6/8   | 12 x 60               | 10 | 1,88              |
| 10CB01-TOM  | M-8/10  | 15 x 85               | 10 | 1,82              |
| 10CB02-TOM  | M-8/10  | 16 x 130              | 10 | 2,28              |
| 10CB011-TOM | M-8/10  | 16 x 330 Fotovoltaica | 5  | 3,47              |
| 10CB03-TOM  | M-12    | 20 x 85               | 10 | 2,40              |

Imprescindible para anclajes en presencia de ladrillos huecos.



**Taco de Nylon para Argolla de Andamio**

| Refer:        | Medida   |    | Precio €<br>Caja |
|---------------|----------|----|------------------|
| 101114100-TEX | 14 x 100 | 40 | 7,90             |



**Argolla de Andamio**

| Refer:     | Medida   | ∅<br>Interno |    | Precio €<br>Caja |
|------------|----------|--------------|----|------------------|
| TOC1212-GB | 12 x 120 | 23 mm        | 25 | 40,17            |

**Tacos de Vuelco de MUELLE**

| <u>Refer:</u> | <u>Descripción</u>                     | <u>Medida</u> |  | <u>Precio €</u><br><u>Caja</u> |
|---------------|--|---------------|---|--------------------------------|
| 1004020-TOM   | Espárrago con arandela y tornillo      | M-4 x 75      | 50  | 24,12                          |
| 1004022-TOM   | Espárrago con arandela y tornillo      | M-5 x 95      | 50  | 27,04                          |
| 1004028-TOM   | Espárrago con arandela y tornillo      | M-8 x 100     | 50  | 41,27                          |
| 1004024-TOM   | Gancho abierto con arandela y tornillo | M-4 x 75      | 50  | 25,68                          |
| 1004025-TOM   | Gancho abierto con arandela y tornillo | M-5 x 95      | 50  | 29,52                          |
| 873002-IFT    | Gancho cerrado con arandela y tornillo | M-5 x 100     | 50  | 21,82                          |

**Tacos de Vuelco BASCULANTE**

| <u>Refer:</u> | <u>Descripción</u>                     | <u>Medida</u> |  | <u>Precio €</u><br><u>Caja</u> |
|---------------|--|---------------|---|--------------------------------|
| 874031-IFT    | Con tornillos y arandelas              | M-6 x 130     | 40  | 20,50                          |
| 874001-IFT    | Gancho cerrado con arandela y tornillo | M-6 x 130     | 40  | 22,31                          |

**Accesorio Vuelco para varilla**

| <u>Refer:</u> | <u>Descripción</u> | <u>∅</u> |  | <u>Caja</u> |
|---------------|--------------------|----------|---|-------------|
| 875001-IFT    | Basculante M-5     | 16 mm    | 100   | 23,88       |
| 1004026-TOM   | Muelle M-8         | 22 mm    | 50  | 26,18       |

**Abrazaderas Sin Fin Metálicas**

Acero Cincado

Flejes de 9 mm

Tornillo de cabeza hexagonal con ranura

| <u>Refer:</u> | <u>Rango de Apertura</u> |  | <u>Precio €</u><br><u>Caja</u> |
|---------------|--------------------------|---|--------------------------------|
| 124/0812-WH   | De 8 a 12 mm             | 100   | 32,56                          |
| 124/0816-WH   | De 10 a 16 mm            | 100   | 34,20                          |
| 124/1220-WH   | De 12 a 22 mm            | 100   | 36,91                          |
| 124/1625-WH   | De 16 a 27 mm            | 100   | 37,78                          |
| 124/2032-WH   | De 20 a 32 mm            | 100   | 40,70                          |
| 124/2540-WH   | De 25 a 40 mm            | 50  | 21,54                          |
| 124/3250-WH   | De 32 a 50 mm            | 50  | 23,26                          |
| 124/4060-WH   | De 40 a 60 mm            | 50  | 26,81                          |
| 124/5070-WH   | De 50 a 70 mm            | 25  | 14,60                          |
| 124/6080-WH   | De 60 a 80 mm            | 25  | 15,53                          |
| 124/7090-WH   | De 70 a 90 mm            | 25  | 15,85                          |
| 124/80100-WH  | De 80 a 100 mm           | 25  | 16,26                          |
| 124/90110-WH  | De 90 a 110 mm           | 25  | 16,56                          |
| 124/100120-WH | De 100 a 120 mm          | 25  | 17,06                          |
| 124/110130-WH | De 110 a 130 mm          | 25  | 18,26                          |
| 124/120140-WH | De 120 a 140 mm          | 25  | 19,14                          |



Para instalación de tubos de agua, electricidad, gas y calefacción

Elevada resistencia térmica (de -40° a +80°)

Fabricado en Poliamida 6 Nylon Gris

Para guías de: 20x10 - 25x7,5 - 27x18

**Abrazaderas de Nylon LPH para tubos**

| <u>Refer:</u> | <u>Ø</u>   |  | <u>Precio €</u><br><u>Caja</u> |
|---------------|------------|---|--------------------------------|
| 25531-TOM     | 15 - 18 mm | 100   | 22,56                          |
| 25532-TOM     | 20 - 25 mm | 50  | 15,87                          |
| 25533-TOM     | 25 - 32 mm | 50  | 17,86                          |



Abrazaderas de PVC ideadas para la

fijación de tubos plásticos de 16 a 40 mm

Fabricado en PVC autoextinguible

**Abrazaderas de Nylon E-CLIP para tubos**

| <u>Refer:</u>  | <u>Ø</u> |  | <u>Precio €</u><br><u>Caja</u> |
|----------------|----------|---|--------------------------------|
| 8713502116-ELM | 16 mm    | 100   | 10,05                          |
| 8713502120-TOM | 20 mm    | 100   | 10,74                          |
| 8713502125-TOM | 25 mm    | 100   | 12,72                          |
| 8713502132-TOM | 32 mm    | 50  | 8,97                           |
| 8713502140-ELM | 40 mm    | 50  | 15,75                          |

**Abrazadera Metálica Gas Butano**

| <u>Refer:</u> | <u>Ø</u> |  | <u>Precio €</u><br><u>Caja</u> |
|---------------|----------|---|--------------------------------|
| 123/1618-WH   | 16-18 mm | 100   | 32,75                          |

Especial para el cierre de gomas de butano al regulador de gas.

## anclaje metálico tornillo



calidad 6.8



| refer     | medida      |  |  |
|-----------|-------------|---|---|
| 70080645  | Ø8 M6x45    | 200   | 44,02   |
| 70080660  | Ø8 M6x60    | 200   | 51,07   |
| 70100860  | Ø10 M8x60   | 100   | 35,00   |
| 70100880  | Ø10 M8x80   | 100   | 41,19   |
| 70121070  | Ø12 M10x70  | 100   | 57,48   |
| 701210100 | Ø12 M10x100 | 50  | 34,72   |
| 70141070  | Ø14 M10x70  | 100   | 73,61   |
| 701410100 | Ø14 M10x100 | 50  | 44,74   |
| 70161280  | Ø16 M12x80  | 50  | 55,13   |
| 701612110 | Ø16 M12x110 | 50  | 66,98   |
| 702016110 | Ø20 M16x110 | 25  | 61,60   |



## anclaje metálico gancho



| refer    | medida     |  |  |
|----------|------------|---|---|
| 78080645 | Ø8 M6x45   | 100   | 40,66   |
| 78100860 | Ø10 M8x60  | 100   | 66,81   |
| 78121070 | Ø12 M10x70 | 50  | 54,15   |

## anclaje metálico argolla



| refer    | medida     |  |  |
|----------|------------|---|---|
| 77080645 | Ø8 M6x45   | 100   | 40,66   |
| 77100860 | Ø10 M8x60  | 100   | 66,81   |
| 77121070 | Ø12 M10x70 | 50  | 54,15   |

**Brocas HSS Laminadas para Metal**

| <u>Refer:</u> | <u>Medida</u>        | <u>Precio €</u> |
|---------------|----------------------|-----------------|
| 471/01-FX     | 1 x 34               | 0,31            |
| 471/015-FX    | 1.5 x 40             | 0,32            |
| 471/02-FX     | 2 x 49               | 0,34            |
| 471/025-FX    | 2.5 x 57             | 0,36            |
| 471/03-FX     | 3 x 61               | 0,39            |
| 471/0325-FX   | 3.25 x 65            | 0,40            |
| 471/035-FX    | 3.5 x 70             | 0,44            |
| 471/0375-FX   | 3.75 x 70            | 0,45            |
| 471/04-FX     | 4 x 75               | 0,45            |
| 471/045-FX    | 4.5 x 80             | 0,56            |
| 471/05-FX     | 5 x 86               | 0,56            |
| 471/0525-FX   | 5.25 x 86            | 0,63            |
| 471/055-FX    | 5.5 x 93             | 0,59            |
| 471/0575-FX   | 5.75 x 93            | 0,66            |
| 471/06-FX     | 6 x 93               | 0,66            |
| 471/065-FX    | 6.5 x 101            | 0,70            |
| 471/07L-FX    | 7 x 150 <b>larga</b> | 2,13            |
| 471/07-FX     | 7 x 109              | 0,81            |
| 471/075-FX    | 7.5 x 109            | 0,99            |

| <u>Refer:</u> | <u>Medida</u> | <u>Precio €</u> |
|---------------|---------------|-----------------|
| 471/08-FX     | 8 x 117       | 1,40            |
| 471/085-FX    | 8.5 x 117     | 1,40            |
| 471/09-FX     | 9 x 125       | 1,42            |
| 471/095-FX    | 9.5 x 125     | 1,67            |
| 471/10-FX     | 10 x 133      | 1,87            |
| 471/11-FX     | 11 x 142      | 2,45            |
| 471/115-FX    | 11.5 x 142    | 2,91            |
| 471/12-FX     | 12 x 151      | 2,91            |
| 471/13-FX     | 13 x 151      | 3,57            |
| 471/14-FX     | 14 x 151      | 5,28            |

*En estuche con 10 / 5 unidades*

**Brocas HSS Rectificadas para Metal**

| <u>Refer:</u> | <u>Medida</u> | <u>Precio €</u> |
|---------------|---------------|-----------------|
| 472/01-FX     | 1 x 34        | 0,42            |
| 472/015-FX    | 1.5 x 40      | 0,49            |
| 472/02-FX     | 2 x 49        | 0,47            |
| 472/025-FX    | 2.5 x 57      | 0,49            |
| 472/03-FX     | 3 x 61        | 0,56            |
| 472/035-FX    | 3.5 x 70      | 0,63            |
| 472/04-FX     | 4 x 75        | 0,70            |
| 472/0425-FX   | 4.25 x 75     | 0,78            |
| 472/045-FX    | 4.5 x 80      | 0,78            |
| 472/05-FX     | 5 x 86        | 0,96            |
| 472/0525-FX   | 5.25 x 86     | 1,05            |
| 472/055-FX    | 5.5 x 93      | 1,07            |
| 472/06-FX     | 6 x 93        | 1,08            |
| 472/065-FX    | 6.5 x 101     | 1,26            |
| 472/07-FX     | 7 x 109       | 1,77            |
| 472/075-FX    | 7.5 x 109     | 2,01            |
| 472/08-FX     | 8 x 117       | 2,18            |
| 472/085-FX    | 8.5 x 117     | 2,37            |
| 472/09-FX     | 9 x 125       | 2,86            |

| <u>Refer:</u> | <u>Medida</u> | <u>Precio €</u> |
|---------------|---------------|-----------------|
| 472/095-FX    | 9.5 x 125     | 3,13            |
| 472/10-FX     | 10 x 133      | 3,47            |
| 472/11-FX     | 11 x 142      | 4,47            |
| 472/12-FX     | 12 x 151      | 5,45            |
| 472/13-FX     | 13 x 151      | 7,10            |
| 472/14-FX     | 14 x 151      | 9,10            |
| 472/15-FX     | 15 x 170      | 9,53            |
| 472/16-FX     | 16 x 178      | 13,46           |
| 472/17-FX     | 17 x 185      | 13,95           |
| 472/18-FX     | 18 x 191      | 14,94           |
| 472/19-FX     | 19 x 191      | 15,20           |
| 472/20-FX     | 20 x 205      | 15,44           |

*En estuche con 10 / 5 unidades*

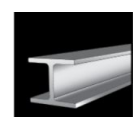

**Brocas HSS Rectificadas para Metal Serie Larga**

| <u>Refer:</u> | <u>Medida</u> | <u>Precio €</u> |
|---------------|---------------|-----------------|
| 472/03L-FX    | 3 x 120       | 1,09            |
| 472/04L-FX    | 4 x 120       | 1,24            |
| 472/05L-FX    | 5 x 132       | 1,70            |
| 472/06L-FX    | 6 x 139       | 2,15            |
| 472/08L-FX    | 8 x 165       | 3,07            |
| 472/10L-FX    | 10 x 184      | 4,30            |

*En estuche con 10 / 5 unidades*

**Brocas HSS Cobalto 5 % para Metal**

| <u>Refer:</u> | <u>Medida</u> | <u>Precio €</u> |
|---------------|---------------|-----------------|
| 474/01-FX     | 1 x 34        | 0,36            |
| 474/015-FX    | 1.5 x 40      | 0,42            |
| 474/02-FX     | 2 x 49        | 0,45            |
| 474/025-FX    | 2.5 x 57      | 0,57            |
| 474/03-FX     | 3 x 61        | 0,66            |
| 474/0325-FX   | 3.25 x 65     | 0,86            |
| 474/035-FX    | 3.5 x 70      | 0,86            |
| 474/0375-FX   | 3.75 x 75     | 0,93            |
| 474/04-FX     | 4 x 75        | 1,08            |
| 474/0425-FX   | 4.25 x 75     | 1,37            |
| 474/045-FX    | 4.5 x 80      | 1,37            |
| 474/0475-FX   | 4.75 x 85     | 1,40            |
| 474/05-FX     | 5 x 85        | 1,43            |
| 474/0525-FX   | 5.25 x 85     | 1,46            |
| 474/055-FX    | 5.5 x 93      | 1,50            |
| 474/06-FX     | 6 x 93        | 1,70            |
| 474/065-FX    | 6.5 x 101     | 2,18            |
| 474/07-FX     | 7 x 109       | 2,47            |
| 474/075-FX    | 7.5 x 109     | 2,86            |

| <u>Refer:</u> | <u>Medida</u> | <u>Precio €</u> |
|---------------|---------------|-----------------|
| 474/08-FX     | 8 x 117       | 3,10            |
| 474/085-FX    | 8.5 x 117     | 3,78            |
| 474/09-FX     | 9 x 125       | 4,34            |
| 474/095-FX    | 9.5 x 125     | 4,73            |
| 474/10-FX     | 10 x 130      | 5,69            |
| 474/105-FX    | 10.5 x 130    | 6,16            |
| 474/11-FX     | 11 x 140      | 7,20            |
| 474/115-FX    | 11.5 x 140    | 9,05            |
| 474/12-FX     | 12 x 151      | 9,43            |
| 474/13-FX     | 13 x 151      | 10,12           |
| 474/14-FX     | 14 x 155      | 11,65           |

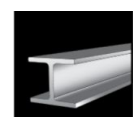
*En estuche con 10 / 5 unidades*

**Brocas Escalonadas HSS TIN para Metal**

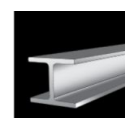
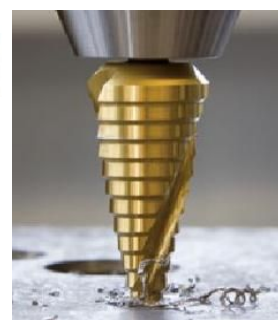
| <u>Refer:</u> | <u>Medida</u> | <u>Precio €</u> |
|---------------|---------------|-----------------|
| 443/2-TOM     | 4-20 mm       | 16,13           |
| 443/3-TOM     | 4-30 mm       | 27,85           |
| 443/4-TOM     | 6-40 mm       | 44,64           |





**Brocas Widia "SUPER" Profesional**

| Largo Estandar |          |          |
|----------------|----------|----------|
| Refer:         | Medida   | Precio € |
| 478/03-FX      | 3 x 60   | 0,70     |
| 478/04-FX      | 4 x 75   | 0,77     |
| 478/05-FX      | 5 x 85   | 0,85     |
| 478/06-FX      | 6 x 100  | 0,97     |
| 478/07-FX      | 7 x 100  | 1,21     |
| 478/08-FX      | 8 x 120  | 1,66     |
| 478/10-FX      | 10 x 120 | 2,33     |
| 478/12-FX      | 12 x 150 | 3,20     |
| 478/13-FX      | 13 x 150 | 4,15     |
| 478/14-FX      | 14 x 150 | 4,50     |
| 478/15-FX      | 15 x 150 | 6,04     |
| 478/16-FX      | 16 x 150 | 6,45     |
| 478/18-FX      | 18 x 150 | 7,15     |
| 478/19-FX      | 19 x 160 | 8,30     |
| 478/20-FX      | 20 x 160 | 8,95     |

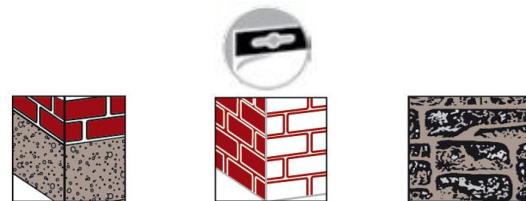
| Serie Larga |          |          |
|-------------|----------|----------|
| Refer:      | Medida   | Precio € |
| 478/05L-FX  | 5 x 150  | 1,55     |
| 478/06L-FX  | 6 x 200  | 1,61     |
| 478/07L-FX  | 7 x 200  | 2,25     |
| 478/08L-FX  | 8 x 200  | 2,33     |
| 478/09L-FX  | 9 x 200  | 2,84     |
| 478/10L-FX  | 10 x 200 | 2,90     |
| 478/12L-FX  | 12 x 200 | 4,03     |

*En funda de plástico individual*

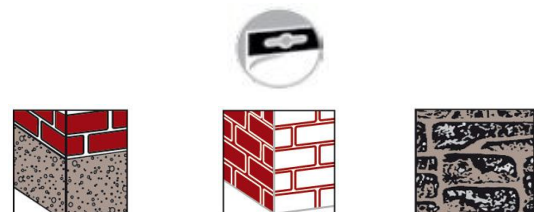
**Brocas Widia Pasamuros Profesional**

| Refer:    | Medida   | Precio € |
|-----------|----------|----------|
| 482/06-FX | 6 x 400  | 3,57     |
| 482/08-FX | 8 x 400  | 3,90     |
| 482/10-FX | 10 x 400 | 5,65     |
| 482/12-FX | 12 x 400 | 8,76     |
| 482/14-FX | 14 x 400 | 10,75    |
| 482/16-FX | 16 x 400 | 13,72    |
| 482/18-FX | 18 x 400 | 17,16    |
| 482/20-FX | 20 x 400 | 18,74    |

*En funda de plástico individual*

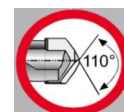
**Brocas SUPERCUT para materiales de gran dureza y Porcelanato**
**DIN 8039 / ISO 5468**

| Refer:    | Medida   | Precio € |
|-----------|----------|----------|
| 483/05-FX | 5 x 85   | 4,96     |
| 483/10-FX | 10 x 120 | 9,79     |

*\*Hasta fin de stock\**
*En funda de plástico individual*

**Recomendaciones de uso:**

- Azulejos
- Tejas
- Piedra Cerámica hasta dureza de grado 9
- Materiales Porcelánicos
- Cerámicas Duras

- Trabajar a bajas revoluciones
- Únicamente en rotación, sin percusión
- Refrigerar cada 20 segundos



**Brocas Widia "SDS Plus" para Hormigón**

| Refer:       | Medida   | Precio € |
|--------------|----------|----------|
| 479/04110-FX | 4 x 110  | 2,70     |
| 479/05110-FX | 5 x 110  | 2,70     |
| 479/06110-FX | 6 x 110  | 3,02     |
| 479/08110-FX | 8 x 110  | 4,60     |
| 479/10110-FX | 10 x 110 | 4,80     |
| 479/05160-FX | 5 x 160  | 3,02     |
| 479/06160-FX | 6 x 160  | 3,02     |
| 479/07160-FX | 7 x 160  | 4,75     |
| 479/08160-FX | 8 x 160  | 4,75     |
| 479/09160-FX | 9 x 160  | 4,80     |
| 479/10160-FX | 10 x 160 | 4,80     |
| 479/12160-FX | 12 x 160 | 4,95     |
| 479/06210-FX | 6 x 210  | 3,90     |
| 479/08210-FX | 8 x 210  | 4,80     |
| 479/10210-FX | 10 x 210 | 5,30     |
| 479/12210-FX | 12 x 210 | 5,45     |
| 479/13210-FX | 13 x 210 | 5,90     |
| 479/14210-FX | 14 x 210 | 6,50     |
| 479/16210-FX | 16 x 210 | 6,90     |
| 479/18210-FX | 18 x 210 | 8,13     |

| Refer:       | Medida   | Precio € |
|--------------|----------|----------|
| 479/08310-FX | 8 x 310  | 5,40     |
| 479/10310-FX | 10 x 310 | 5,60     |
| 479/12310-FX | 12 x 310 | 6,15     |
| 479/14310-FX | 14 x 310 | 7,76     |

*En funda de plástico individual*

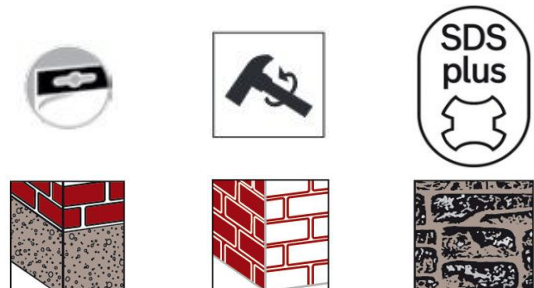
|              |          |       |
|--------------|----------|-------|
| 479/08450-FX | 8 x 450  | 6,18  |
| 479/10450-FX | 10 x 450 | 6,25  |
| 479/12450-FX | 12 x 450 | 6,90  |
| 479/14450-FX | 14 x 450 | 9,13  |
| 479/16450-FX | 16 x 450 | 11,98 |
| 479/18450-FX | 18 x 450 | 14,68 |
| 479/20450-FX | 20 x 450 | 18,35 |

**Brocas especiales para Cristal y Azulejos**

| Refer:    | Medida  | Precio € |
|-----------|---------|----------|
| 485/04-FX | 4 x 60  | 3,62     |
| 485/05-FX | 5 x 70  | 3,73     |
| 485/06-FX | 6 x 75  | 4,82     |
| 485/08-FX | 8 x 80  | 5,94     |
| 485/10-FX | 10 x 85 | 7,45     |

- Azulejos
- Cristales
- Tejas
- Botellas
- Cerámicas
- Metacrilato

- Trabajar a bajas revoluciones
- Trabajar con refrigeración
- Utilizar sólo con rotación

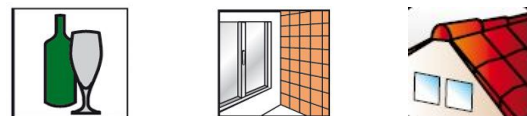

*En funda de plástico individual*

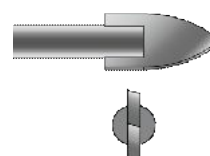



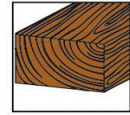
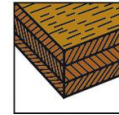

**Brocas de Tres Puntas para Madera**

| <u>Refer:</u> | <u>Medida</u> | <u>Precio €</u> |
|---------------|---------------|-----------------|
| 480/03-FX     | 3 x 60        | 0,55            |
| 480/04-FX     | 4 x 75        | 0,59            |
| 480/05-FX     | 5 x 85        | 0,81            |
| 480/06-FX     | 6 x 95        | 1,03            |
| 480/07-FX     | 7 x 100       | 1,39            |
| 480/08-FX     | 8 x 115       | 1,66            |
| 480/09-FX     | 9 x 115       | 1,98            |
| 480/10-FX     | 10 x 135      | 2,43            |
| 480/12-FX     | 12 x 155      | 3,60            |

| <u>Refer:</u> | <u>Medida</u> | <u>Precio €</u> |
|---------------|---------------|-----------------|
| 480/13-FX     | 13 x 170      | 3,95            |
| 480/22-FX     | 22 x 210      | 12,25           |
| 480/24-FX     | 24 x 215      | 15,00           |

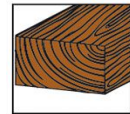
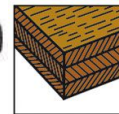
*En funda de plástico individual*



**Brocas de Tres Puntas para Madera Serie Larga**

| <u>Refer:</u> | <u>Medida</u> | <u>Precio €</u> |
|---------------|---------------|-----------------|
| 465/06300-PR  | 6 x 300       | 3,52            |
| 465/08450-PR  | 8 x 400       | 5,68            |
| 465/10450-PR  | 10 x 400      | 6,98            |

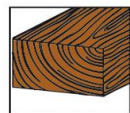
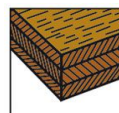
*En funda de plástico individual*

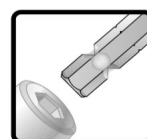

**Brocas de Tres Puntas para Madera Inserción Hexagonal 1/4"**

| <u>Refer:</u> | <u>Medida</u> | <u>Precio €</u> |
|---------------|---------------|-----------------|
| 480H/03-FX    | 3 x 82        | 1,11            |
| 480H/06-FX    | 4 x 96        | 1,15            |
| 480H/05-FX    | 5 x 106       | 1,32            |
| 480H/06-FX    | 6 x 113       | 1,44            |
| 480H/08-FX    | 8 x 117       | 1,78            |



*En funda de plástico individual*

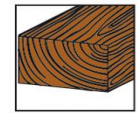
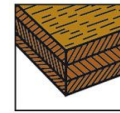
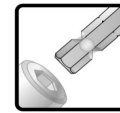



En funda de plástico individual

**Brocas de Pala para Madera**

| Refer:    | Medida   | Precio € |
|-----------|----------|----------|
| 481/08-FX | 8 x 155  | 1,56     |
| 481/10-FX | 10 x 155 | 1,63     |
| 481/12-FX | 12 x 155 | 1,72     |
| 481/14-FX | 14 x 155 | 1,79     |
| 481/16-FX | 16 x 155 | 1,84     |
| 481/18-FX | 18 x 155 | 1,91     |
| 481/20-FX | 20 x 155 | 1,98     |
| 481/22-FX | 22 x 155 | 2,15     |

| Refer:    | Medida   | Precio € |
|-----------|----------|----------|
| 481/24-FX | 24 x 165 | 2,20     |
| 481/25-FX | 25 x 165 | 2,34     |
| 481/28-FX | 28 x 165 | 2,51     |
| 481/30-FX | 30 x 165 | 2,98     |
| 481/32-FX | 32 x 165 | 3,35     |
| 481/35-FX | 35 x 165 | 3,44     |
| 481/38-FX | 38 x 165 | 3,56     |
| 481/40-FX | 40 x 165 | 3,88     |

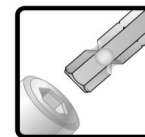

**Alargadera para Brocas de Pala de 150 mm**

Refer: 3057H245-TOP

Incluye llave Allen para apriete

Precio € 5,70



**Brocas HSS Rectificadas para Metal Inserción Hexagonal 1/4"**

| Refer:      | Medida   | Precio € |
|-------------|----------|----------|
| 484/02H-FX  | 2 x 70   | 0,55     |
| 484/025H-FX | 2,5 x 75 | 0,61     |
| 484/03H-FX  | 3 x 77   | 0,85     |
| 484/035H-FX | 3,5 x 85 | 0,91     |
| 484/04H-FX  | 4 x 88   | 1,02     |
| 484/045H-FX | 4,5 x 95 | 1,21     |
| 484/05H-FX  | 5 x 105  | 1,45     |
| 484/06H-FX  | 6 x 105  | 2,20     |

En bolsa de plástico con 10 uds.

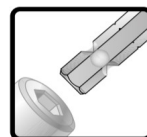

**Brocas Widia "SUPER" Profesional Inserción Hexagonal 1/4"**

| Refer:     | Medida   | Precio € |
|------------|----------|----------|
| 478H/05-FX | 5 x 85   | 1,64     |
| 478H/06-FX | 6 x 100  | 1,86     |
| 478H/08-FX | 8 x 117  | 2,19     |
| 478H/10-FX | 10 x 117 | 2,64     |

En funda de plástico individual

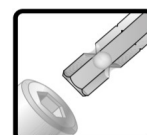



**Juego Brocas HSS Laminadas, 13 pzs**

| Refer:  | Medidas  | Precio € |
|---------|--|----------|
| 450-TOM | 1.5, 2, 2.5, 3, 3.2, 3.5, 4, 4.5, 4.8, 5, 5.5, 6, 6.5 mm | 5,28     |



**Juegos Brocas de Cobalto**

| Refer:    | Medidas            | Precio €     |
|-----------|--------------------|--------------|
| 45213-TOM | 1,5 - 6,5 mm x 0,5 | 13 pzs 20,24 |
| 45214-TOM | 1,0 - 10 mm x 0,5  | 19 pzs 48,02 |



**Juego Brocas Mixtas, 9 pzs**

| Refer: | Medidas                | Precio € |
|--------|------------------------|----------|
| 458-PR | 5, 6, 8 mm             | 5,45     |
|        | Metal - Pared - Madera |          |



**Juego Brocas Porcelánico, 5 pzs**

| Refer: | Medidas           | Precio € |
|--------|-------------------|----------|
| 483-FX | 4, 5, 6, 8, 10 mm | 36,01    |

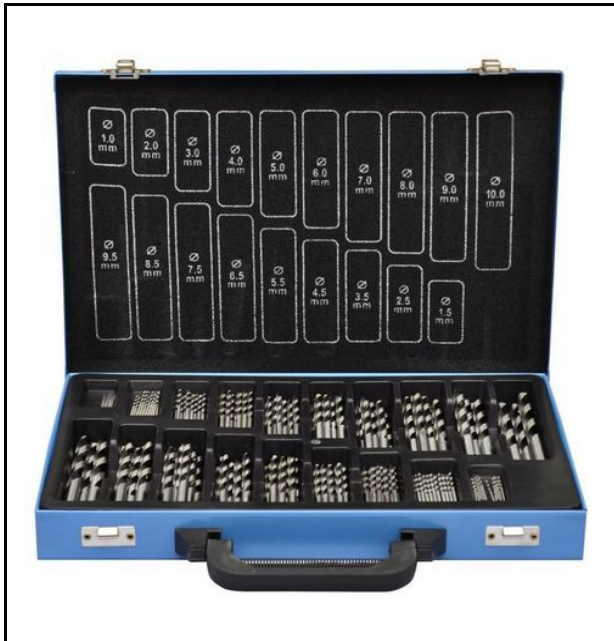

**Maletín Vacío para Brocas Hss**

| <u>Refer:</u> | <u>Medidas</u>        | <u>Precio €</u> |
|---------------|-----------------------|-----------------|
| 474BOX-FX     | 1 mm a 10 mm x 0,5 mm | 19,54           |



**Juego Brocas de Widia, 5 pzs**

| <u>Refer:</u> | <u>Medidas</u>    | <u>Precio €</u> |
|---------------|-------------------|-----------------|
| 466/5-TOM     | 4, 5, 6, 8, 10 mm | 4,34            |



**Juego Brocas HSS 1/4" Hexagonal, 5 pzs**

| <u>Refer:</u> | <u>Medidas</u>    | <u>Precio €</u> |
|---------------|-------------------|-----------------|
| 3057H750-TOP  | 4, 5, 6, 8, 10 mm | 14,62           |



**Juego Brocas para Madera, 8 pzs**

| <u>Refer:</u> | <u>Medidas</u>             | <u>Precio €</u> |
|---------------|----------------------------|-----------------|
| 463/8-PR      | 3, 4, 5, 6, 7, 8, 9, 10 mm | 6,75            |



**TOMISA**  
7 BROCAS  
PCS SDS PLUS  
SDS plus

8.0 6.0 5.0 4.5 4.0 3.5 3.0

SDS PLUS  
PARA METAL

**Juego Brocas Hss Sds Plus, 7 pzs**

| Refer:  | Medidas                      | Precio € |
|---------|------------------------------|----------|
| 479-TOM | 3, 3.5, 4, 4.5<br>5, 6, 8 mm | 22,56    |



**TOMISA**  
7 BROCAS  
PCS SDS PLUS  
SDS plus

10 8 6 8 6

**Juego Brocas Hormigón Sds Plus, 7 pzs**

| Refer:     | Medidas                                   | Precio € |
|------------|---|----------|
| 101035-TOM | 5, 6, 8 x 110 mm<br>6, 8, 10, 12 x 160 mm | 20,45    |



**Juego Brocas Hss, 19 pzs**

| Refer:     | Medidas           | Precio € |
|------------|-------------------|----------|
| 101010-TOM | 1,0 - 10 mm x 0,5 | 12,64    |



**Juego Brocas Escalonadas Hss Tin, 3 pzs**

| Refer:     | Medidas             | Precio € |
|------------|---------------------|----------|
| 101116-TOM | 4-12, 4-20, 4-30 mm | 31,75    |

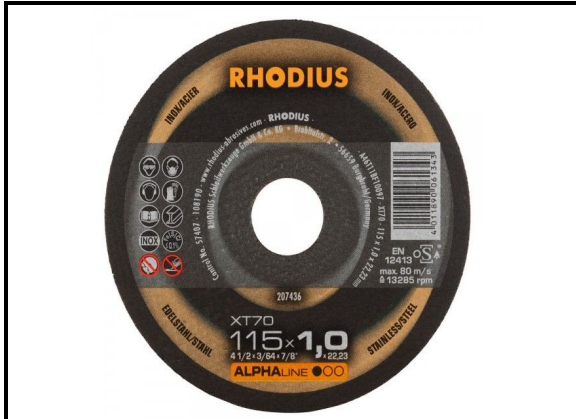

**Disco de Corte para INOX**

|               |                   |     |                 |
|---------------|-------------------|-----|-----------------|
| <b>Refer:</b> |                   |     | <b>Precio €</b> |
| 29207436-ROD  | 115 x 1,0 x 22,23 | 100 | 1,26            |

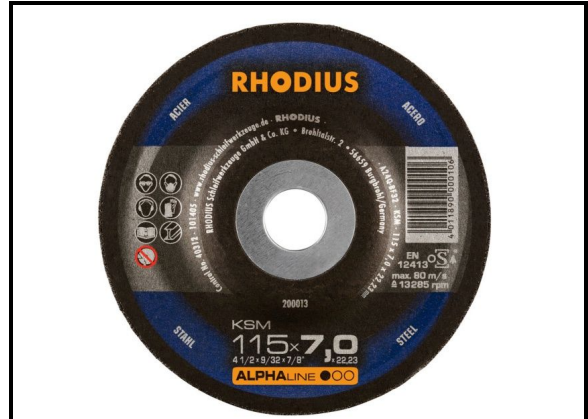

**Disco Desbaste para Acero**

|               |                   |    |                 |
|---------------|-------------------|----|-----------------|
| <b>Refer:</b> |                   |    | <b>Precio €</b> |
| 29200013-ROD  | 115 x 7,0 x 22,23 | 25 | 3,52            |

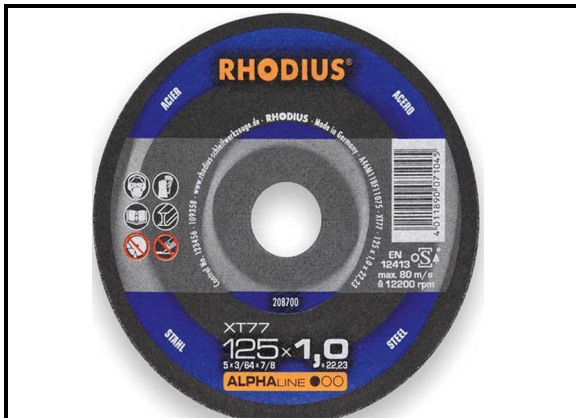

**Disco de Corte para Acero**

|               |                   |     |                 |
|---------------|-------------------|-----|-----------------|
| <b>Refer:</b> |                   |     | <b>Precio €</b> |
| 29208698-ROD  | 115 x 1,0 x 22,23 | 100 | 1,37            |
| 29200631-ROD  | 115 x 3,0 x 22,23 | 25  | 1,82            |

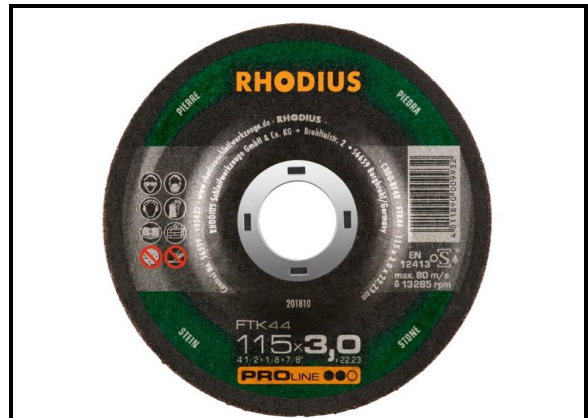

**Disco de Corte para Piedra**

|               |                   |    |                 |
|---------------|-------------------|----|-----------------|
| <b>Refer:</b> |                   |    | <b>Precio €</b> |
| 29204625-ROD  | 115 x 1,5 x 22,23 | 50 | 3,10            |
| 29201810-ROD  | 115 x 3,0 x 22,23 | 25 | 2,32            |



**Disco Desbaste para Piedra**

|                 |              |     |    |                 |
|-----------------|--------------|-----|----|-----------------|
| <b>Refer:</b>   | <b>Grano</b> |     |    | <b>Precio €</b> |
| 76DSFC11536-TOM | 36           | 115 | 10 | 3,41            |
| 76DSFC11560-TOM | 60           | 115 | 10 | 3,41            |
| 76DSFC11580-TOM | 80           | 115 | 10 | 3,41            |
| 76DSFC18060-TOM | 60           | 180 | 10 | 4,73            |

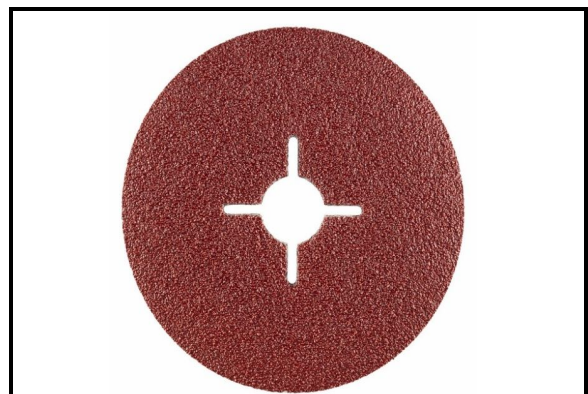

**Disco Abrasivo para Metal**

|               |              |     |    |                 |
|---------------|--------------|-----|----|-----------------|
| <b>Refer:</b> | <b>Grano</b> |     |    | <b>Precio €</b> |
| 29300001-ROD  | 16           | 115 | 25 | 1,03            |
| 29300002-ROD  | 24           | 115 | 25 | 0,91            |
| 29300003-ROD  | 36           | 115 | 25 | 0,88            |
| 29300006-ROD  | 60           | 115 | 25 | 0,82            |
| 29300008-ROD  | 100          | 115 | 25 | 0,76            |



**Disco Diamante para "Madera"**

| Refer:      | ⊕           | 📦  | Precio € |
|-------------|-------------|----|----------|
| 29CDM115-GM | 115 x 22,23 | 10 | 8,17     |
| 29CDM230-GM | 230 x 22,23 | 5  | 21,81    |



**Disco Diamante Segmentado**

| Refer:     | ⊕                 | 📦 | Precio € |
|------------|-------------------|---|----------|
| 57H616-TOM | 115 x 2,1 x 22,23 | 1 | 5,46     |
| 57H619-TOM | 230 x 2,7 x 22,23 | 1 | 19,84    |



**Disco Diamante Porcelánico**

| Refer:       | ⊕                     | 📦 | Precio € |
|--------------|-----------------------|---|----------|
| 29303101-ROD | 115 x 1,2 x 5 x 22,23 | 1 | 32,49    |
| 29303104-ROD | 230 x 1,2 x 5 x 22,23 | 1 | 70,48    |



**Disco Diamante Segmentado**

| Refer:       | ⊕                     | 📦 | Precio € |
|--------------|-----------------------|---|----------|
| 29303185-ROD | 115 x 2,0 x 7 x 22,23 | 1 | 16,25    |
| 29303189-ROD | 230 x 2,4 x 7 x 22,23 | 1 | 45,54    |

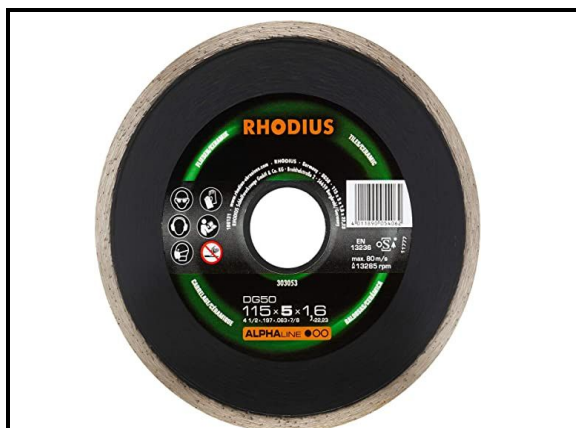

**Disco Diamante Liso**

| Refer:       | ⊕                       | 📦 | Precio € |
|--------------|-------------------------|---|----------|
| 29303053-ROD | 115 x 1,6 x 5,0 x 22,23 | 1 | 12,34    |



**Disco Diamante Continuo**

| Refer:       | ⊕                     | 📦 | Precio € |
|--------------|-----------------------|---|----------|
| 29303402-ROD | 115 x 1,9 x 7 x 22,23 | 1 | 16,41    |

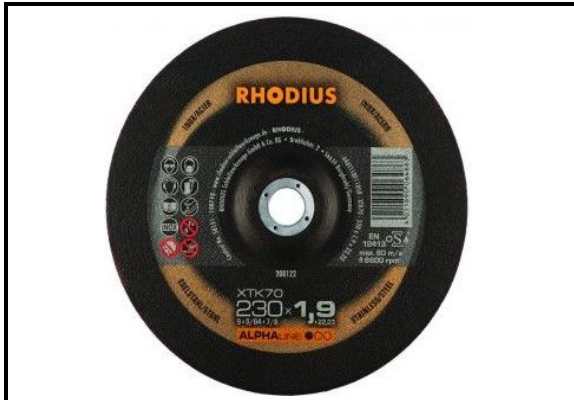

**Disco de Corte para INOX**

|               |                   |                 |
|---------------|-------------------|-----------------|
| <b>Refer:</b> | ⊕                 | <b>Precio €</b> |
| 29208122-ROD  | 230 x 1,9 x 22,23 | 25 3,10         |

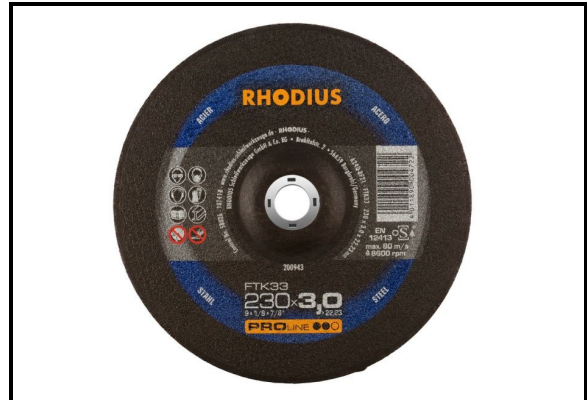

**Disco de Corte para Acero**

|               |                   |                 |
|---------------|-------------------|-----------------|
| <b>Refer:</b> | ⊕                 | <b>Precio €</b> |
| 29200995-ROD  | 230 x 2,0 x 22,23 | 25 4,22         |
| 29200943-ROD  | 230 x 3,0 x 22,23 | 25 4,38         |

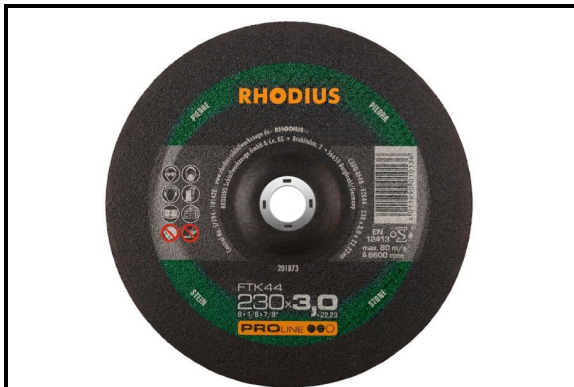

**Disco de Corte para Piedra**

|               |                   |                 |
|---------------|-------------------|-----------------|
| <b>Refer:</b> | ⊕                 | <b>Precio €</b> |
| 29201873-ROD  | 230 x 3,0 x 22,23 | 25 4,23         |



**Disco Abrasivo de Polifibra**

|               |             |                 |
|---------------|-------------|-----------------|
| <b>Refer:</b> | ⊕           | <b>Precio €</b> |
| 76PFCD-TOM    | 115 x 22,23 | 10 8,99         |



**Disco de Láminas Abrasivo**

|               |              |             |                 |
|---------------|--------------|-------------|-----------------|
| <b>Refer:</b> | <b>Grano</b> | ⊕           | <b>Precio €</b> |
| 76393540-TOM  | 40           | 115 x 22,23 | 20 2,02         |
| 76393560-TOM  | 60           | 115 x 22,23 | 20 2,02         |
| 76393580-TOM  | 80           | 115 x 22,23 | 20 2,02         |
| 763935100-TOM | 100          | 115 x 22,23 | 20 2,02         |
| 763935120-TOM | 120          | 115 x 22,23 | 20 2,02         |
| 76393940-TOM  | 40           | 180 x 22,23 | 20 4,48         |
| 76393960-TOM  | 60           | 180 x 22,23 | 20 4,48         |



**Disco de Feltro Abrasivo**

|               |             |                 |
|---------------|-------------|-----------------|
| <b>Refer:</b> | ⊕           | <b>Precio €</b> |
| 76DLFEL-TOM   | 115 x 22,23 | 10 6,38         |



# TOMISA

# GRAPHITE

## Discos Diamante



General  
de obra

### SEGMENTADO

3057H616-TOP  
3057H619-TOP

| Ø         | €       |     |
|-----------|---------|-----|
| 115 x 2,1 | 5,46 €  | PVP |
| 230 x 2,7 | 19,84 € | PVP |



General  
de obra



### TURBO

57H625-TOP  
57H630-TOP

| Ø         | €       |     |
|-----------|---------|-----|
| 115 x 2,4 | 5,86 €  | PVP |
| 230 x 3,1 | 20,39 € | PVP |



Cerámica



Baldosas

### LISO

57H640-TOP  
57H646-TOP

| Ø         | €       |     |
|-----------|---------|-----|
| 115 x 2,1 | 5,42 €  | PVP |
| 230 x 2,7 | 19,69 € | PVP |



## DISCO 115 X 1 MM

Ref: 9422WA/50-MOR

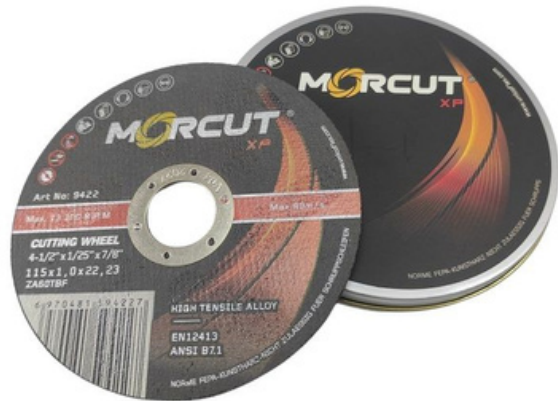

## DISCO 115 X 1 MM

Ref: 9422ZA/10-MOR



## DISCO 230 X 1,9 MM

Ref: 9458ZA/25-MOR



¿PROBLEMAS CON LOS ATRANQUES?  
 ¡¡¡OLVÍDESE!!!

**COMETODO**  
 (DESATASCADOR DE DESAGÜES)



1 kg.                      2 kg.

**G.Q.A. PRODUCTOS DE CALIDAD**

**Desatascador De Desagües**

| Refer:     | Contenido       |  | Precio € |
|------------|-----------------|--|----------|
| 5003/1-GQA | 0,5 L # 1 Kilo  | 12   | 4,15     |
| 5003/2-GQA | 1,0 L # 2 Kilos | 8  | 7,15     |

¿PROBLEMAS CON LA CAL?  
 CALENTADORES, INTERCAMBIADORES DE CALOR, SERPENTINES, VERDÍN EN LAS PISCINAS, W.C., MAMPARAS DE BAÑO, ETC...

¿PROBLEMAS CON EL CEMENTO?  
 LIMPIADOR DE JUNTAS, GRESITE, HORMIGONERAS, PLANCHAS DE ENCOFRAO, GRES RÚSTICO, SALITRE, FRAGUADO, ETC...

¡¡¡OLVÍDESE!!!

**COMETODO**  
 (CEMENTO Y CAL)



1 l.                              5 l.

**G.Q.A. PRODUCTOS DE CALIDAD**

**Desincrustante para Cemento y Cal**

| Refer:    | Contenido |  | Precio € |
|-----------|-----------|--|----------|
| 806/1-GQA | 1 Litro   | 8  | 4,15     |
| 806/5-GQA | 5 Litros  | 4  | 18,16    |



**Desengrasante Multiusos**

| Refer:    | Contenido |  | Precio € |
|-----------|-----------|---|----------|
| 807/1-GQA | 750 ml    | 8   | 5,10     |



**Ecogel Cucarachas en Jeringuilla**

Refer:

- 2809L100-PC
- 2809L035-PC

Contenido

- 5 gramos
- 10 gramos



- 12
- 12

**Precio €**

- 4,90
- 6,48

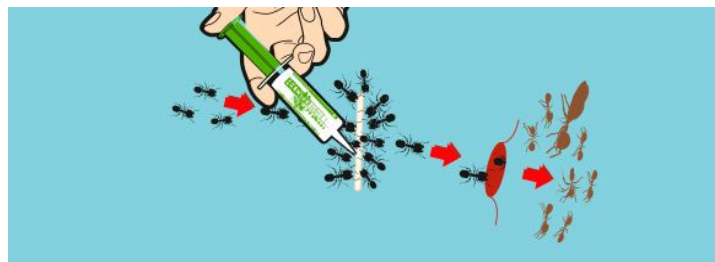

**Ecogel Hormigas en Jeringuilla**

Refer:

- 28094001-PC

Contenido

- 5 gramos



- 12

**Precio €**

- 4,90

**Ecogel Trampas Cucarachas y Hormigas**

| Refer:    | Contra     | Contenido |          |    | Precio € |
|-----------|------------|-----------|----------|----|----------|
| 209191-PC | Cucarachas | 15 gramos | 6 x caja | 10 | 5,40     |
| 209207-PC | Hormigas   | 15 gramos | 3 x caja | 12 | 5,40     |

**Raticida en Cebo Fresco y Bloque**

| Refer:     | Tipo        | Contenido  |    | Precio € |
|------------|-------------|------------|----|----------|
| 2810200-PC | Cebo Fresco | 150 gramos | 24 | 3,90     |
| 209068-PC  | Bloque      | 300 gramos | 12 | 8,49     |

|  |  |   |
|--|--|---|
| <ul style="list-style-type: none"> <li>• ALTA VISCOSITÀ</li> <li>• PENETRA A FONDO NEGLI INGRANAGGI</li> </ul><br><ul style="list-style-type: none"> <li>• MÁXIMA ADHERENCIA</li> </ul><br><ul style="list-style-type: none"> <li>• PENETRA A FONDO EN LOS ENGRANAJES</li> </ul> |  <p>400ml</p> | <p><b>GT-GR08 GRASSO MULTIUSO</b></p> <p><b>ALTA VISCOSITÀ ANCHE IN CONDIZIONI DIFFICILI</b></p> <p>Fluido ad alta viscosità di elevata qualità ad alto potere penetrante. Buona stabilità chimica, ottima idrorepellenza e adesività. Protegge dall'acqua e dagli agenti atmosferici, resistente in ambienti salini, polverosi, resistente alle soluzioni basiche ed acide. Ideale per la lubrificazione di cuscinetti, catene, linee di trasmissione, attrezzature marine, imbarcazioni, snodi, perni, guide ed in generale nel settore degli autoveicoli, macchine agricole ed industriali, dispositivi di trasmissione ad alta velocità e ad alte temperature di esercizio. Penetra a fondo negli ingranaggi prolungandone la vita e l'efficienza.</p> <p><b>GRASA DE PROTECCIÓN MÁXIMA ADHERENCIA - INCLUSO EN CONDICIONES EXTREMAS</b></p> <p>Fluido de alta viscosidad y gran calidad con alto poder de penetración. Buena estabilidad química, una excelente repelenza d' agua y buena adherencia. Protege contra el agua y resiste a la intemperie en ambientes salinos, protege del polvo, es resistente a las soluciones ácidas y básicas. Ideal para la lubricación de los rodamientos, cadenas, líneas de transmisión, equipos marinos, vasos, juntas, pivotes, guías y en general en la maquinaria agrícola e industrial, aparatos para la transmisión de alta velocidad y altas temperaturas de funcionamiento. Penetra profundamente en los engranajes prolongando su vida útil y la eficiencia de los mismos.</p>   |
| <p><b>Grasa Multiuso en Spray</b></p>  |  |   |
| <p><b>Refer:</b><br/>GT-GR08-GB</p>  | <p><b>Contenido</b><br/>400 ml</p>   | <p> 12 <b>Precio €</b><br/>6,50</p>  |

|  |  |   |
|--|--|---|
| <ul style="list-style-type: none"> <li>• MULTIUSO</li> <li>• ANTIRUGGINE</li> </ul><br><ul style="list-style-type: none"> <li>• MULTIUSOS</li> <li>• ANTI CORROSIÓN</li> </ul> |  <p>400ml</p> | <p><b>GT-SB07 SBLOCCANTE RAPIDO</b></p> <p><b>ANTIRUGGINE PROTETTIVO MULTIUSO</b></p> <p>Fluido sintetico ad alto potere solvente e sblocca nte, libera rapidamente dadi, bulloni, giunti, filetti, serrature, lucchetti, cerniere, catene, attrezzature meccaniche e utensili manuali dalla ruggine e dalle ossidazioni. Forma inoltre un velo protettivo durevole, idrofugo e idrorepellente. Prolunga la vita degli ingranaggi e ne previene l'usura.</p> <p><b>DESBLOQUEO RÁPIDO PROTECCIÓN ANTI CORROSIÓN - MULTIUSOS</b></p> <p>Fluido sintético con alto poder disolvente y desbloqueante libera rápidamente tuercas, tornillos, juntas, hilos de rosca, cierres, tornillería, bisagras, cadenas, equipo mecánico y herramientas de mano de la corrosión, herrumbre y oxidación. También forma una película resistente, impermeable, protectora y repelente d' agua. Prolonga la vida útil de los engranajes y evita el desgaste prematuro.</p>   |
| <p><b>Desblocante Aflojado en Spray</b></p>  |  |   |
| <p><b>Refer:</b><br/>GT-SB07-GB</p>  | <p><b>Contenido</b><br/>400 ml</p>   | <p> 12 <b>Precio €</b><br/>5,71</p>  |

**GEBOTeC**  
Professional

- LUBRIFICANTE PURÍSSIMO
- PER STRUMENTI E INGRANAGGI DI PRECISIONE
- LUBRIFICANTE PURO
- PARA LUBRICAR Y PROTEGER LOS ENGRANAJES DE PRECISIÓN



400 ml



**GT-VS11 OLIO DI VASELINA PURÍSSIMO**

**LUBRIFICANTE PROTETTIVO**

Inodore, incolore, non macchia. Ideale per lubrificare e proteggere strumenti di precisione, cerniere, serrature, attrezzi, ingranaggi, trasmissioni, macchine tessili e per ufficio, piani di scorrimento in linea e macchine alimentari, per usi professionali e domestici.  
Crea una pellicola fluida impermeabile ed elasticizzante sul legno evitandone le screpolature. Mantiene la pelle e il cuoio morbidi ed elastici. Adatto per metalli, gomma, legno, pelle e cuoio.

**ACEITE DE VASELINA LUBRIFICANTE DE PROTECCIÓN**

Sin olor, incoloro, no mancha. Ideal para lubricar y proteger las herramientas de precisión, bisagras, cerraduras, herramientas, engranajes, transmisiones, maquinaria textil para piel o cuero, maquinaria de oficina y líneas de maquinaria para alimentación, máquinas para usos profesionales y domésticos.  
Crea una película de fluido impermeable y elástica en la madera, evitando las grietas. Mantiene la piel, suavidad y elasticidad de la misma. Adecuado para metal, goma, madera, cuero y piel.

**Aceite de Vaseline en Spray**

Refer:  
GT-VS11-GB

Contenido  
400 ml

  
12

**Precio €**  
5,46

**GEBOTeC**  
Professional

- PROTETTIVO
- ANTIRUGGINE
- FINITURA BRILLANTE
- PROTECCIÓN
- ANTIOXIDANTE
- EFFECTO BRILLO



400 ml

**GT-Z06 ZINCO BRILLANTE**

**ZINCANTE SPRAY BRILLANTE PROTETTIVO - ANTIRUGGINE ANTICORROSIONE - AZIONE GALVANIZZANTE A FREDDO**

Zincante spray a freddo ad alta concentrazione ideale nei ritocchi e nella rifinitura di giunti, saldature e riparazioni di parti galvanizzate. Adatto per ringhiere e cancellate in metallo, strutture in acciaio, carrozzeria, idraulica e accessori, grondaie, opere di saldatura, riparazioni su serbatoi e cisterne, carpenteria metallica, edilizia, officine, fai-da-te. Dona effetto lucido alle superfici verniciate. Ottima resistenza alla corrosione, alla ruggine e agli agenti atmosferici su tutti i materiali ferrosi. Forma una protezione ad alta elasticità che resiste alla screpolatura e allo scolorimento. Essicca rapidamente e non cola. Può essere lasciato come protezione finale oppure carteggiato e/o sovraverniciato.  
Spessore strato: 15/20 micron. Resa: 2/25 m<sup>2</sup> per bombola. Tempo di asciugatura: 15/20 minuti circa.

**ZINCADO EN SPRAY ACABADO BRILLO - PROTECCIÓN CONTRA EL MOHO, LA CORROSIÓN - ACCIÓN GALVANIZADO EN FRÍO**

Zincado aerosol en frío de alta concentración, ideal para el acabado y últimos retoques en soldaduras, reparaciones, juntas y piezas galvanizadas. Adecuado para barandilla, puertas, metal, acero, estructuras, sistemas hidráulicos, accesorios y candones, trabajos de soldadura, reparación de tanques y cisternas, carpintería metálica construcción, garajes, bricolaje en general. Da efecto pulido a las superficies pintadas brillantes. Excelente resistencia a la corrosión. La herrumbre y el desgaste en todos los materiales ferrosos. Forma una capa elástica de alta seguridad que resiste el agrietamiento y la decoloración. Se seca rápidamente y no gotea. Sepuede dejar como protección final y/o pintar.  
Grosor: 15/20 micras. Rendimiento: 2/25 metros cuadrados por bote. Tiempo de secado: 15/20 minutos



**Zincado Protector en Spray**

Refer:  
GT-Z06-GB

Contenido  
400 ml

  
12

**Precio €**  
6,93

| GT-HQ09<br><b>SILICONE SPRAY HQ</b>  |   | Silicona Impermeabilizante en Spray   |   |
|--|---|---|---|
|  |   | Refer:  | Contenido   |
|  |   | GT-HQ09-GB  | 400 ml  |
|  |   |   | Precio €<br>5,82  |
| <ul style="list-style-type: none"> <li>EXTRA IMPERMEABILIZZANTE</li> </ul>         |  | <br>12 | <p><b>ALTA QUALITÀ - EXTRA PROTETTIVO IMPERMEABILIZZANTE</b></p> <p>Silicone spray ad alte prestazioni per l'industria plastica, gomma e taglio. Incolore, inodore, esente da solventi, temperatura di lavoro da -40° C a +250° C. Ideale come distaccante per gli stampi di materie plastiche. Protettivo e lubrificante, rilascia una pellicola impermeabile su ogni tipo di materiale trattato prevenendo l'accumulo di cariche elettrostatiche. È efficace come lucidante e protettivo sulle parti plastiche e protegge le guarnizioni da scie poltiture aumentandone la tenuta e la durata. Utilizzato anche nei settori nautica, campeggio e per usi domestici. Non verniciabile.</p> |
|  | <ul style="list-style-type: none"> <li>EXTRA IMPERMEABILIZACIÓN</li> </ul>        |   |   |
|  |   | <p>400 ml</p>   |   |

| GT-RS12<br><b>RIMUOVI SILICONE</b>  |   | Eliminador de Silicona en Spray   |  |
|---|---|---|--|
|   |   | Refer:  | Contenido  |
|   |   | GT-RS12-GB  | 400 ml   |
|   |   |   | Precio €<br>6,02   |
| <ul style="list-style-type: none"> <li>RAPIDO</li> <li>NON AGGRESSIVO</li> </ul>    |  | <br>12 | <p><b>SOLVENTE RAPIDO NON AGGRESSIVO PER TUTTE LE SUPERFICI</b></p> <p>Formulazione a base di solventi adatti per sciogliere e rimuovere le eccedenze e i residui di silicone. Azione immediata sul silicone fresco, necessita di un breve tempo di reazione sul silicone indurito. In caso di una notevole quantità di silicone, si consiglia di asportarne meccanicamente il più possibile, prima di applicare il prodotto. Adatto per qualsiasi superficie. Non è aggressivo. Non opacizza.</p> |
|   | <ul style="list-style-type: none"> <li>RÁPIDO</li> <li>NO AGRESIVO</li> </ul>       |   |  |
|  |   | <p>400ml</p>  |  |



**GEBOTeC**  
*Professional*

**LIMPIADOR ALTA PRESIÓN  
(AIRE COMPRIMIDO)**



400ml

Elimina inmediatamente el polvo depositado en las superficies menos accesibles. Está indicado para la limpieza de lentes, objetivos, ordenadores, relojes y mecánica sensible a la suciedad.

- **LENTES, COMPUTADORAS, HERRAMIENTAS DE PRECISIÓN**



**Limpiador de Aire a Presión**

Refer:  
GT-AP-GB

Contenido  
400 ml

📦  
12

**Precio €**  
5,74

**GEBOTeC**  
*Professional*

**PULIDOR CONTACTO ELECTRICO**



400ml

Específico para la limpieza a fondo de contactos eléctricos, electrónicos y electromagnéticos. Elimina al instante la humedad y la suciedad presentes en la superficie a tratar como la grasa, aceite, cera, cola, dejando el área tratada limpia y libre de grasa. Si se utiliza sobre superficies delicadas, puede dañar las mismas.

- **EFICACIA INMEDIATA  
PROLONGA LA VIDA  
DEL CONTACTO ELECTRICO**



**Limpiador de Contactos Eléctricos**

Refer:  
GT-PE-GB

Contenido  
400 ml

📦  
12

**Precio €**  
5,52

|  |                                    |   |                                 |
|--|------------------------------------|---|---------------------------------|
|  |                                    | <b>GT-CUT10 OLIO DA TAGLIO PER FILIERE</b>  |                                 |
| <ul style="list-style-type: none"> <li>• LUBRIFICANTE PER FILIERE</li> <li>• LUBRIFICANTE PARA ROSCAR</li> </ul> |                                    | <p><b>OLIO DA TAGLIO INTERO PER FILIERE</b></p> <p>Prodotto lubrificante innovativo di alta qualità ad azione protettiva per utensili e attrezzature di filiera. Progettato per applicazioni professionali specifiche nel settore della lavorazione e taglio dei metalli ad elevata durezza.</p> <p>GT-CUT10 è costituito da basi minerali paraffiniche arricchite con speciali additivi EP anti-saldamenti. Ideale per operazioni gravose di macchina e filettatura di acciai particolarmente duri e legati.</p> <p>Adatto anche per il settore idraulico.</p>                     |                                 |
|  | <p>400ml</p>                       | <p><b>ACEITE DE CORTE PARA ROSCAR</b></p> <p>Producto lubricante de alta calidad para operaciones difíciles, de acción protectora sobre los utensilios. GT-CUT10 es un nuevo producto estudiado para aplicaciones profesionales específicas, en el sector del corte de metales de elevada dureza. El aceite utilizado tiene una composición a base de minerales parafínicos enriquecidos con aditivos especiales EP anti-adherivos.</p> <p>Ideal para operaciones difíciles de rosado en acero particularmente duro y en aleaciones.</p> <p>Especial para el sector hidráulico.</p> |                                 |
|  |                                    |   |                                 |
| <p><b>Aceite de Corte y Roscado</b></p>  |                                    |   |                                 |
| <p><u>Refer:</u><br/>GT-CUT10-GB</p>   | <p><u>Contenido</u><br/>400 ml</p> | <p> 12</p>  | <p><b>Precio €</b><br/>6,43</p> |

|  |                                    |   |                                 |
|--|------------------------------------|---|---------------------------------|
|  |                                    |   |                                 |
| <p>500 ml</p>                                  |                                    | <p><b>LIMPIEZA DE FRENOS Y PARTES MECANICAS</b></p> <p>Detergente especial particularmente eficaz para frenos, embragues y todas las partes mecánicas que necesitan ser desengrasada sin enjuagar. Disuelve y elimina rápidamente aceite, grasa y cualquier otro tipo de suciedad.</p> <p>Especialmente adecuado para el engranaje alto rendimiento mecánico.</p> <p><b>● RAPIDO - SIN ACLARADO</b></p> |                                 |
|  |                                    |   |                                 |
| <p><b>Limpiador de Frenos y Engranajes</b></p> |                                    |   |                                 |
| <p><u>Refer:</u><br/>GT-27-GB</p>              | <p><u>Contenido</u><br/>500 ml</p> | <p> 12</p>  | <p><b>Precio €</b><br/>6,13</p> |

|   |  |                                    |  |                                 |
|---|--|------------------------------------|--|---------------------------------|
|  |  |                                    |  |                                 |
|  |   |                                    |  |                                 |
|   |   |                                    |  |                                 |
|   | <p>GT-SALD<br/><b>DISTACCANTE<br/>ANTISPRUZZI</b><br/>PER SALDATURE</p> <p>ANTI-SPATTER FOR WELDING<br/>ANTI-PROIEZIONI DI SODADURA<br/>SCHUTZFILM</p> |                                    |  |                                 |
|   |   |                                    |  |                                 |
| <p><b>Antisalpicaduras de Soldadura</b></p>                                       |  |                                    |  |                                 |
| <p><u>Refer:</u><br/>GT-SALD-GB</p>   |  | <p><u>Contenido</u><br/>400 ml</p> | <p><br/>12</p> | <p><u>Precio €</u><br/>5,80</p> |

**ANTIPROIEZIONI  
DE SODADURA**

Producto a base de polímeros de película sintética, que por sus específicas propiedades impide el recalentamiento del cordón de soldadura en cualquier soporte. Otra película de agentes químicos impide la formación de corrosión. Es ideal para la soldadura autógena eléctrica y a base de gas inerte. El producto no contiene silicona.

● **FILM DE PROTECCIÓN**



|   |  |                                    |   |                                 |
|---|--|------------------------------------|---|---------------------------------|
|  |  |                                    |   |                                 |
|  |   |                                    |   |                                 |
|   |   |                                    |   |                                 |
|   | <p>GT-SLIDER<br/><b>SCIVOLANTE-SCORRICAVO</b><br/>PER TUBI E CAVI ELETTRICI</p> <p>FACILITA IL MONTAGGIO<br/>E PROLUNGA LA VITA DEI MATERIALI</p> <p>LUBE FOR PIPES AND CABLES<br/>LUBRICANTE - DESLIZA CABLES<br/>PARA CABLEADOS Y TUBOS<br/>FÜR ROHR - UND KABEL</p> |                                    |   |                                 |
|   |   |                                    |   |                                 |
| <p><b>Spray Lubricante Pasacables</b></p>   |  |                                    |   |                                 |
| <p><u>Refer:</u><br/>GT-SLIDER-GB</p>   |  | <p><u>Contenido</u><br/>400 ml</p> | <p><br/>12</p> | <p><u>Precio €</u><br/>5,77</p> |

Facilita el paso de cables eléctricos por las fundas. Para una correcta instalación sin atascos ni gripamientos. No daña las cubiertas de plástico ni tampoco las de cualquier goma además de proteger los cables del envejecimiento. Lubricante para el tendido de instalaciones eléctricas, telefonía y fibra óptica.





De aplicación en los más diferentes sectores industriales.  
 Óptimas propiedades adhesivas, protectoras y deslizantes.  
 Penetra en profundidad y garantiza una lubricación duradera.  
 Reduce el coeficiente de fricción y desgaste.  
 Agitar el envase y rociar entre placas.

Apariencia: Pasta/ Blanco pálido  
 Densidad Relativa: 0,73 g/ml

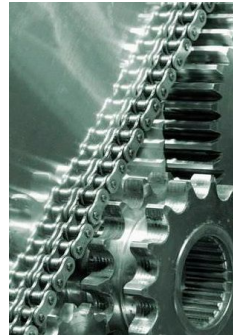

**Grasa de Litio + PTFE en Spray**

Refer:  
 82P400-VM

Contenido  
 400 ml

 12

Precio €  
 5,46

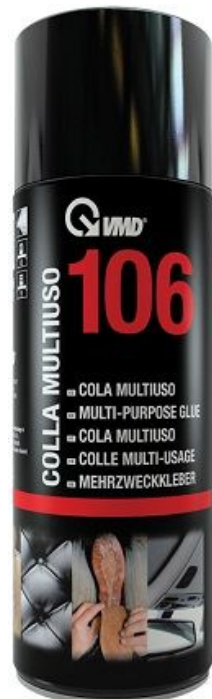

Producto de alta calidad, indispensable para el profesional y el particular. Actúa con gran rapidez.  
 El suministro y la distribución del producto son regulables mediante una especial válvula de distribución.  
 Fácil de usar, el spray permite pegar materiales de diferente tipo, como metales, plástico, madera, materiales expandidos, vidrio y papel.  
 Áreas de Aplicación: Automoción, ferretería e industria, oficina, hidráulica y náutica.  
 Limpiar las superficies antes de aplicar y unir las partes presionando para mejor adherencia.



**Cola Adhesiva de Contacto en Spray**

Refer:  
 106P400-VM

Contenido  
 400 ml

 12

Precio €  
 7,15



Permite un arranque rápido incluso a bajas temperaturas. Indicado para maquinaria agrícola y construcción, así como para barcos y vehículos de obra pública.

Areas de Aplicación: Automoción, ferretería e industria y náutica.

Aspecto: Líquido/Transparente, Incoloro  
Densidad Relativa: 0,70 g/ml



**Autoarranque Rápido para Motores**

Refer:

42P400-VM

Contenido

400 ml



12

Precio €

5,94



Un agente protector antiácido para bornes de batería, es el producto ideal para prevenir la sulfatación y la corrosión de los bornes de cobre o bronce. Resiste grandes variaciones de temperatura.

Areas de Aplicación: Automoción y náutica.

Aspecto: Líquido/Pastoso Color Rosa  
Densidad Relativa: 0,73 g/ml



**Protector de Bornes de Baterías**

Refer:

79P400-VM

Contenido

400 ml



12

Precio €

6,34



Aerosol seco ideal para lubricar todo tipo de cerraduras, candados y bisagras. Forma una película estable frente al calor y es conductora de electricidad. Se usa en los casos en que no se desea que haya aceites. Al lubricar, facilita el buen funcionamiento de piezas con riesgo de sufrir rayas y roces. Es ideal para cualquier tipo de mecanismo de deslizamiento, tales como guías, portones, cancelas basculantes y correderas. Se seca muy rápido. Es resistente al agua y los aceites. No retiene la suciedad ni el polvo. Resiste de -45° hasta 450°.

Areas de Aplicación: Automoción, ferretería e industria y náutica.



**Lubricante a base de Grafito**

Refer:

93P200-VM

Contenido

200 ml

12

**Precio €**  
4,45



Revestimiento protector a base de acero inoxidable micronizado con características anticorrosivas, idóneo para proteger y restablecer todo tipo de metales (acero, hierros, zincados, aluminio, etc.) Presenta una excelente adhesión y una vez que se seca, forma una película flexible, compacta y resistente que luego se puede pintar. Alta resistencia a agentes atmosféricos a los golpes, a los rayones, a la corrosión, y a los rayos ultravioleta. Limpiar bien cualquier zona oxidada.

Areas de Aplicación: Industria y náutica.



**Recubrimiento Inox en Spray**

Refer:

33P400-VM

Contenido

400 ml

12

**Precio €**  
8,26



Marcaje fluorescente profesional para obras de albañilería, madera, asfalto y pavimentaciones. Resistente a los agentes atmosféricos, el aerosol tiene una válvula especial de 360° para facilitar su empleo en cualquier posición. Es una pintura de marcaje temporal que se degrada con el paso del tiempo para que no quede resto.

Aspecto: Líquido de Color  
Densidad Relativa: 0,90 g/ml

**Marcadores de Obra Fluorescentes**

| <u>Refer:</u> | <u>Color</u> | <u>Contenido</u> |    | <u>Precio €</u> |
|---------------|--------------|------------------|----|-----------------|
| 64FLUO/AMA-VM |              | 500 ml           | 12 | 6,58            |
| 64FLUO/AZU-VM |              | 500 ml           | 12 | 6,58            |
| 64FLUO/NAR-VM |              | 500 ml           | 12 | 6,58            |
| 64FLUO/ROJ-VM |              | 500 ml           | 12 | 6,58            |
| 64FLUO/VER-VM |              | 500 ml           | 12 | 6,58            |
| 64FLUO/FUX-VM |              | 500 ml           | 12 | 6,58            |



Barniz de elevada calidad y alta capacidad de cobertura a base de resinas silicónicas modificadas. Resistente a temperaturas hasta 600°. Ideal para acabados y/o para renovar todas las superficies sujetas a elevadas temperaturas no expuestas a contacto directo con la llama como estufas, hogares, calderas, hornos, conductos de humo, barbacoas, colectores, silenciadores de escape, pinxas de freno, etc. El producto seca al aire pero para una correcta reticulación es necesaria la cocción a 100° por 10'.

Densidad Relativa: 0,9 g/ml

**Pintura Anticalórica Altas Temperaturas**

| <u>Refer:</u> | <u>Color</u> | <u>Contenido</u> |   | <u>Precio €</u> |
|---------------|--------------|------------------|---|-----------------|
| 100HTP4-VM    | Negro        | 400 ml           | 6 | 7,15            |
| 100HTDP4-VM   | Plata        | 400 ml           | 6 | 10,73           |
| 209058        | Antracita    | 400 ml           | 6 | 10,73           |



**Contenido**  
400 ml



Pintura acrílica de uso profesional y alta adhesividad. Ideal para las operaciones de pintura de materiales metálicos y plásticos. Producto de rápido secado, poder cubriente y sobrepintable. Realice siempre una prueba de compatibilidad del producto con el soporte a tratar.

Aspecto: Líquido de Color



### Pintura Acrílica en spray

| Refer:       | Color | Descripción      | Precio € | Refer:     | Color | Descripción     | Precio € |
|--------------|-------|------------------|----------|------------|-------|-----------------|----------|
| RAL9005M-VM  |       | Negro Mate       | 4,65     | RAL5015-VM |       | Azul Cielo      | 4,65     |
| RAL9005B-VM  |       | Negro Brillo     | 4,65     | RAL5017-VM |       | Azul Tráfico    | 4,65     |
| RAL9005S-VM  |       | Negro Satinado   | 4,65     | RAL5005-VM |       | Azul Señal      | 4,65     |
| RAL9003-VM   |       | Blanco Señal     | 4,65     | RAL2009-VM |       | Naranja Tráfico | 4,65     |
| RAL9010EL-VM |       | Blanco Electrodo | 4,65     | RAL3000-VM |       | Rojo Fuego      | 4,65     |
| RAL9010B-VM  |       | Blanco Brillo    | 4,65     | RAL3020-VM |       | Rojo Tráfico    | 4,65     |
| RAL9010S-VM  |       | Blanco Satinado  | 4,65     | RAL6029-VM |       | Verde Menta     | 4,65     |
| RAL9010M-VM  |       | Blanco Mate      | 4,65     | RAL6009-VM |       | Verde Abeto     | 4,65     |
| RAL8011-VM   |       | Marrón Nuez      | 4,65     | RAL6001-VM |       | Verde Esmeralda | 4,65     |
| RAL1023-VM   |       | Amarillo Tráfico | 4,65     | RAL7001-VM |       | Gris Plata      | 4,65     |



Limpiador efectivo para todas las instalaciones y equipos de oficina, como computadoras, impresoras, etc. Ideal para limpiar y desinfectar cualquier superficie en el hogar u oficina. Se evapora sin dejar ningún residuo. Elimina la suciedad y las cargas estáticas. Antes de la aplicación, se recomienda probar su compatibilidad con los materiales. No lo use en equipos activos, no opere el circuito antes de que el producto se haya evaporado por completo.

Áreas de Aplicación: Oficinas y hogar.



### Alcohol Isopropílico en spray

| Refer:    | Contenido | Precio € |
|-----------|-----------|----------|
| 89P400-VM | 400 ml    | 8,12     |



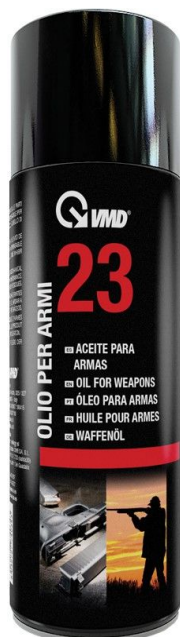

Lubricante protector con elevadas propiedades de penetración y limpieza. Adecuado para el mantenimiento de las partes mecánicas de armas en general. Inhibe el efecto corrosivo debido a las cenizas de la pólvora. Indispensable para el almacenaje. El producto tiene una función preventiva de lubricación y también después del uso, la de inhibir la formación de residuos de hollín.

Areas de Aplicación: Deporte, defensa, ferretería y armería.



**Aceite Lubricante para Armas**

Refer:

23P200-VM

Contenido

200 ml



12

Precio €

5,13



Lubricante antigripante para cadenas y piezas mecánicas de bicicletas con excelente penetración capaz de otorgar una lubricación de larga duración y una protección total. Reduce la fricción y el consumo de energía, repelente al agua. Permite un funcionamiento óptimo de todos los mecanismos de la bicicleta mejorando su rendimiento mecánico. Se puede aplicar a la cadena, palancas, cables y desviadores.

Areas de Aplicación: Deporte y ferretería.

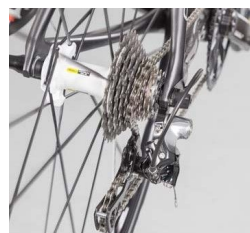

**Lubricante para Bicicletas**

Refer:

40P200-VM

Contenido

200 ml



12

Precio €

5,36



Elimina y previene la formación de malos olores creados por mohos, microorganismos Y moho en los sistemas de aire acondicionado industriales, civiles y de automóviles. Rocíe el producto directamente en los filtros o en el interior de los orificios durante pocos segundos por medio de la cánula, deje actuar durante algunos minutos hasta que se disuelva la espuma antes de encender la instalación. Evite que el producto entre en contacto con partes eléctricas.

Areas de Aplicación: Automoción y ferretería.





**Higienizador Sistemas de Aire**

Refer:  
16L400-VM

Contenido  
400 ml

  
12

**Precio €**  
4,82



Disolvente para eliminar restos de espuma poliuretánica fresca o de adhesivos. Se usa para limpiar la válvula de la bombona interior y exterior de la pistola de aplicación. También se usa en superficies metálicas para eliminar grasas, aceites, hollín, alquitrán, cera, etc.

Areas de Aplicación: Montaje y ferretería.





**Limpiador Espuma de Poliuretano**

Refer:  
105P500-VM

Contenido  
500 ml

  
12

**Precio €**  
6,82

**Resina de Poliester altas Prestaciones**

| Refer:                              | Contenido        |  | Precio € |
|-------------------------------------|------------------|---|----------|
| CC30-GB                             | 300 ML           | 12  | 6,46     |
| CC40-GB                             | 410 ML           | 12  | 7,82     |
| 10CM12-TOM      Cánulas de Recambio | Bolsa con 12 uds |   | 3,69     |

**Resina Híbrida altas Prestaciones**

| Refer:                              | Contenido        |  | Precio € |
|-------------------------------------|------------------|---|----------|
| CC02-GB                             | 300 ML           | 12  | 7,71     |
| 10CM12-TOM      Cánulas de Recambio | Bolsa con 12 uds |   | 3,69     |

\* Multiposición 360°  
 \* Alto rendimiento de 40 L  
 \* Cortable a los 30 minutos  
 \* Almacenamiento 12 meses  
 \* Fórmula de curado rápido  
 \* Aislamiento acústico 60 db  
 \* Aplicación 2 en 1 con cánula y pistola

**Espuma de Poliuretano para sellado, aislamiento y relleno**

| <u>Refer:</u> | <u>Aplicación</u>  | <u>Contenido</u> |    | <u>Precio €</u> |
|---------------|--------------------|------------------|----|-----------------|
| FM365-TOM     | Cánula y Pistola   | 540 ML           | 12 | 6,73            |
| AA210-TOM     | Cánula de repuesto |                  | 1  | 0,82            |

**Pistola Semi-Prof para Espuma Poliuretano**

| <u>Refer:</u> | <u>Precio €</u> |
|---------------|-----------------|
| 336-TOM       | 14,91           |

Aumenta el rendimiento de la espuma hasta un 30%.  
 Disminuye las post-expansión hasta un 60%.  
 Mantiene el grosor de la espuma estable durante el proceso de aplicación. Más fácil de limpiar.

**\* Válvula teflonada**

**Pistola Prof para Espuma Poliuretano**

| <u>Refer:</u> | <u>Precio €</u> |
|---------------|-----------------|
| 337-TOM       | 23,26           |

Aumenta el rendimiento de la espuma hasta un 30%.  
 Disminuye las post-expansión hasta un 60%.  
 Mantiene el grosor de la espuma estable durante el proceso de aplicación. Más fácil de limpiar.

**\* Boquilla y válvula teflonada**



Aplicable en húmedo



Resistente UV



Pintable

Sellador adhesivo elástico de Polímero MS especialmente formulado para el sellado y pegado de la mayoría de materiales utilizados en construcción. Excelente adhesión sobre metales, piedra, mármol, hormigón, cerámica, vidrio, espejos, madera, etc.

Aplicable en superficies húmedas. Pintable y sin olor.

Alta elasticidad. Resistente a los rayos U.V.

**Polímero MS Altas Prestaciones**

| <u>Refer:</u> | <u>Color</u> | <u>Contenido</u> |  | <u>Precio €</u> |
|---------------|--------------|------------------|---|-----------------|
| 46002B        | Blanco       | 280 ML           | 25  | 7,00            |
| 46003G        | Gris         | 280 ML           | 25  | 7,00            |
| 46401T        | Transparente | 280 ML           | 25  | 7,73            |



Aplicable en húmedo



Resistente UV



Pintable

Sellador adhesivo elástico de Polímero MS especialmente formulado para el sellado y pegado de la mayoría de materiales utilizados en construcción. Excelente adhesión sobre metales, piedra, mármol, hormigón, cerámica, vidrio, espejos, madera, etc.

Aplicable en superficies húmedas. Pintable y sin olor.

Alta elasticidad. Resistente a los rayos U.V.

**MS-TURBO AGARRE INMEDIATO**

**Polímero MS TURBO pegado rápido**

| <u>Refer:</u> | <u>Color</u> | <u>Contenido</u> |  | <u>Precio €</u> |
|---------------|--------------|------------------|---|-----------------|
| 46TURBO       | Blanco       | 280 ML           | 12  | 7,73            |

# Novedad

## Espuma Poliuretano Manual 750 ml

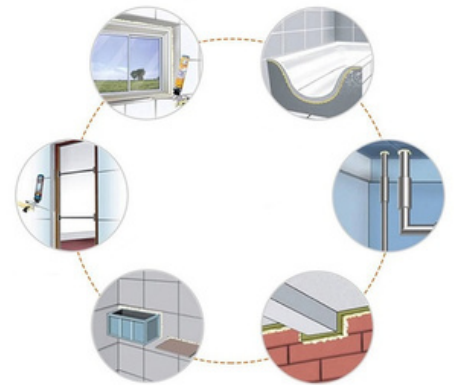
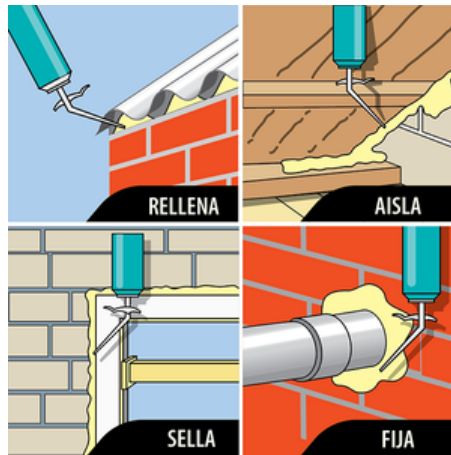

12



Ref: EPUB3M

### Principales usos y características de la espuma de poliuretano

- Excelente capacidad de adherencia sobre todas las superficies (excepto PE, PP, PTFE y siliconas).
- Alta capacidad de aislamiento térmico y acústico.
- Se expande y cura en contacto con humedad.
- Excelente resistencia a altas y bajas temperaturas.
- Temperatura de aplicación recomendada entre +5°C y +35°C.
- Caducidad: 18 meses.
- Rendimiento: 45 L.
- Color: beige.



# Novedad



## Masilla Poliuretano 310 ml



**Blanco**  
RAL 9016  
**396146B**



**Gris**  
RAL 7047  
**396150G**



**Negro**  
RAL 7021  
**396153N**



FACHADA nº2724  
Clase : sellador  
elástico GF 25E



**20**



## Principales usos de este sellador de poliuretano

- Pegado elástico de elementos de construcción (tejas, zócalos, mamparas o rodapiés).
- Sellado de juntas entre tabiques. Tabique de ladrillo y tabique seco.
- Sellado de juntas en el montaje de marcos y mamparas de madera, aluminio o pvc.
- Sellado de juntas en suelos y pavimentos.
- Relleno de grietas y fisuras.
- Uniones sometidas a golpes y vibraciones.
- Sellado de uniones en la industria en general (ventilación, aire acondicionado, automóvil, containers o caravanas).



**Bridas de Nylon Blancas y Negras**

| <b>Blancas</b> |  | <b>Negras</b> |  | <b>Tamaño<br/>Ancho x Largo</b> |     |       | <b>Precio €<br/>Bolsa</b> |
|----------------|--|---------------|--|---------------------------------|-----|-------|---------------------------|
| <b>Refer:</b>  |  | <b>Refer:</b> |  |                                 |     |       |                           |
| 5203-HON       |  | 5303-HON      |  | 2.5 x 100                       | 100 | 50000 | 0,85                      |
| 5201-HON       |  | 5301-HON      |  | 2.5 x 150                       | "   | 25000 | 1,31                      |
| 5207-HON       |  | 5307-HON      |  | 2.5 x 200                       | "   | 25000 | 1,97                      |
| 5208-HON       |  | 5308-HON      |  | 3.6 x 150                       | "   | 12500 | 2,21                      |
| 5214-HON       |  | 5314-HON      |  | 3.6 x 200                       | "   | 15000 | 2,87                      |
| 5211-HON       |  | 5311-HON      |  | 3.6 x 250                       | "   | 10000 | 3,77                      |
| 5210-HON       |  | 5310-HON      |  | 3.6 x 300                       | "   | 10000 | 4,67                      |
| 5213-HON       |  |               |  | 4.8 x 180                       | "   | 10000 | 2,65                      |
| 5215-HON       |  | 5315-HON      |  | 4.8 x 200                       | "   | 10000 | 3,85                      |
| 5216-HON       |  | 5316-HON      |  | 4.8 x 250                       | "   | 7500  | 5,00                      |
| 5218-HON       |  | 5318-HON      |  | 4.8 x 300                       | "   | 5000  | 5,90                      |
| 5219-HON       |  | 5319-HON      |  | 4.8 x 350                       | "   | 5000  | 6,89                      |
| 5221-HON       |  | 5321-HON      |  | 4.8 x 400                       | "   | 5000  | 8,49                      |
| 5222-HON       |  | 5322-HON      |  | 7.6 x 250                       | "   | 1500  | 11,11                     |
| 5224-HON       |  | 5324-HON      |  | 7.6 x 300                       | "   | 2500  | 12,87                     |
| 5226-HON       |  | 5326-HON      |  | 7.6 x 350                       | "   | 2500  | 16,15                     |
| 5228-HON       |  | 5328-HON      |  | 7.6 x 450                       | "   | 1500  | 19,66                     |
| 5236-HON       |  | 5336-HON      |  | 7.8 x 550                       | "   | 1000  | 21,40                     |
| 5233-HON       |  | 5333-HON      |  | 7.6 x 750                       | "   | 1000  | 32,67                     |
| 5238-HON       |  | 5338-HON      |  | 9 x 920                         | "   | 1000  | 48,22                     |
| 5240-HON       |  | 5340-HON      |  | 9 x 1220                        | "   | 500   | 67,62                     |

**Bridas de Nylon Verdes, Marrones, Grises y Azules**

| <b>Verdes</b> | <b>Marrones</b> | <b>Grises</b> | <b>Azules</b> | <b>Tamaño<br/>Ancho x Largo</b> |     | <b>Precio €<br/>Bolsa</b> |
|---------------|-----------------|---------------|---------------|---------------------------------|-----|---------------------------|
| <b>Refer:</b> | <b>Refer:</b>   | <b>Refer:</b> | <b>Refer:</b> |                                 |     |                           |
| 5203/V-HON    |                 |               |               | 2.5 x 100                       | 100 | 0,87                      |
| 5208/V-HON    |                 |               |               | 3.6 x 150                       | "   | 2,28                      |
| 5214/V-HON    | 5214/M-HON      | 5214/G-HON    | 5214/AO-HON   | 3.6 x 200                       | "   | 2,95                      |
| 5218/V-HON    | 5218/M-HON      | 5218/G-HON    | 5218/AO-HON   | 4.8 x 300                       | "   | 6,08                      |



**Bases Atornillables para bridas**

| Refer:        | Medida     | Máximo Brida | Color  |     |  | Precio €<br>Bolsa |
|---------------|------------|--------------|--------|-----|--|-------------------|
| 5499/100B-HON | 15 x 22 mm | 7,8 mm       | Blanco | 100 |  | 5,32              |
| 5499/100N-HON | 15 x 22 mm | 7,8 mm       | Negro  | 100 |  | 5,32              |

**Bases Adhesivas para Bridas Bi-Direccionales**

| Refer:   | Medida         | Máximo Brida | Color  |     |  | Precio €<br>Bolsa |
|----------|----------------|--------------|--------|-----|--|-------------------|
| 5473-ELM | 26.5 x 26.5 mm | 4,8 mm       | Blanco | 100 |  | 8,70              |
| 5475-ELM | 26.5 x 26.5 mm | 4,8 mm       | Negro  | 100 |  | 8,70              |

**Tacos de Nylon para Bridas**

| Refer:        | Medida | Color  |      |     |  | Precio €<br>Bolsa |
|---------------|--------|--------|------|-----|--|-------------------|
| 5456/100B-DE  | 6 x 25 | Blanco | 5000 | 100 |  | 4,51              |
| 5456/100N-DE  | 6 x 25 | Negro  | 5000 | 100 |  | 4,51              |
| 5458/100B-HON | 8 x 45 | Blanco | 5000 | 100 |  | 5,15              |
| 5458/100N-HON | 8 x 45 | Negro  | 5000 | 100 |  | 5,15              |
| 5458/100G-HON | 8 x 45 | Gris   | 5000 | 100 |  | 5,15              |



Con cogida para orificios

**Bridas de nylon con cogida para orificios**

| Refer:      | Medida    | Color  |     | Precio €<br>Bolsa |
|-------------|-----------|--------|-----|-------------------|
| 52155/M-ELM | 3.6 x 150 | Blanco | 100 | 5,82              |
| 52205/M-ELM | 4.8 x 200 | Blanco | 100 | 8,91              |

**Bridas de nylon con DOBLE CIERRE**

| Refer:   | Medida    | Color |     | Precio €<br>Bolsa |
|----------|-----------|-------|-----|-------------------|
| 6455-ELM | 9.0 x 360 | Negro | 100 | 29,35             |
| 6456-ELM | 9.0 x 510 | Negro | 100 | 65,98             |

**Vasos de 1/2" con puntas TORX**

| Refer:         | Medida   | Precio € |
|----------------|----------|----------|
| 2520-PR        | 20 x 55  | 4,30     |
| 2525-PR        | 25 x 55  | 4,30     |
| 2527-PR        | 27 x 55  | 4,30     |
| 2530-PR        | 30 x 55  | 4,30     |
| 2540-PR        | 40 x 55  | 4,30     |
| 2545-PR        | 45 x 55  | 4,30     |
| 2550-PR        | 50 x 55  | 4,30     |
| 2555-PR        | 55 x 55  | 4,30     |
| 2560-PR        | 60 x 55  | 4,95     |
| 2620-PR        | 20 x 100 | 4,60     |
| 2625-PR        | 25 x 100 | 4,60     |
| 2630-PR        | 30 x 100 | 4,60     |
| 2640-PR        | 40 x 100 | 4,60     |
| 2645-PR        | 45 x 100 | 4,60     |
| 2650-PR        | 50 x 100 | 5,52     |
| 2655-PR        | 55 x 100 | 5,52     |
| 2660-PR        | 60 x 100 | 7,83     |
| 3245/TXL70-ELO | 70 x 140 | 17,90    |



**Vasos de 1/2" con puntas XZN**

| Refer:     | Medida             | Precio € |
|------------|--------------------|----------|
| 2350-PR    | 5 x 55             | 4,30     |
| 2351-PR    | 6 x 55             | 4,30     |
| 2352-PR    | 8 x 55             | 4,30     |
| 2353-PR    | 10 x 55            | 4,30     |
| 2354-PR    | 12 x 55            | 4,60     |
| 2355-PR    | 14 x 55            | 5,20     |
| 2356-PR    | 16 x 55            | 5,95     |
| 2357/16-PR | 16 x 55 Inviolable | 7,44     |
| 2360-PR    | 6 x 100            | 4,60     |
| 2361-PR    | 8 x 100            | 4,60     |
| 2362-PR    | 10 x 100           | 4,60     |
| 2363-PR    | 12 x 100           | 8,10     |
| 2364-PR    | 14 x 100           | 8,10     |



**Vasos de 1/2" con puntas HEX**

| Refer:  | Medida   | Precio € |
|---------|----------|----------|
| 2250-PR | 4 x 55   | 4,30     |
| 2251-PR | 5 x 55   | 4,30     |
| 2252-PR | 6 x 55   | 4,30     |
| 2253-PR | 7 x 55   | 4,30     |
| 2254-PR | 8 x 55   | 4,30     |
| 2255-PR | 10 x 55  | 4,30     |
| 2256-PR | 12 x 55  | 4,60     |
| 2257-PR | 14 x 55  | 4,65     |
| 2258-PR | 17 x 55  | 4,70     |
| 2259-PR | 19 x 55  | 5,54     |
| 2260-PR | 5 x 100  | 4,60     |
| 2261-PR | 6 x 100  | 4,60     |
| 2262-PR | 7 x 100  | 4,60     |
| 2263-PR | 8 x 100  | 4,60     |
| 2264-PR | 10 x 100 | 4,75     |
| 2265-PR | 12 x 100 | 4,80     |



**Puntas de 10 mm TORX**

| Refer:    | Medida  |
|-----------|---------|
| 2520/A-PR | 20 x 30 |
| 2525/A-PR | 25 x 30 |
| 2527/A-PR | 27 x 30 |
| 2530/A-PR | 30 x 30 |
| 2540/A-PR | 40 x 30 |
| 2545/A-PR | 45 x 30 |
| 2550/A-PR | 50 x 30 |
| 2555/A-PR | 55 x 30 |
| 2560/A-PR | 60 x 30 |
|           |         |
| 2620/A-PR | 20 x 75 |
| 2625/A-PR | 25 x 75 |
| 2630/A-PR | 30 x 75 |
| 2640/A-PR | 40 x 75 |
| 2645/A-PR | 45 x 75 |
| 2650/A-PR | 50 x 75 |
| 2655/A-PR | 55 x 75 |
| 2660/A-PR | 60 x 75 |



| Precio € |  |
|----------|--|
| 2,45     |  |
| 2,45     |  |
| 2,45     |  |
| 2,45     |  |
| 2,45     |  |
| 2,45     |  |
| 2,45     |  |
| 2,45     |  |
| 2,45     |  |
| 3,10     |  |
|          |  |
| 2,75     |  |
| 2,75     |  |
| 2,75     |  |
| 2,75     |  |
| 2,75     |  |
| 2,75     |  |
| 2,90     |  |
| 3,65     |  |
| 5,50     |  |

**Puntas de 10 mm XZN**

| Refer:    | Medida  |
|-----------|---------|
| 2350/A-PR | 5 x 30  |
| 2351/A-PR | 6 x 30  |
| 2352/A-PR | 8 x 30  |
| 2353/A-PR | 10 x 30 |
| 2354/A-PR | 12 x 30 |
| 2355/A-PR | 14 x 30 |
|           |         |
| 2359/A-PR | 5 x 75  |
| 2360/A-PR | 6 x 75  |
| 2361/A-PR | 8 x 75  |
| 2362/A-PR | 10 x 75 |
| 2363/A-PR | 12 x 75 |
| 2364/A-PR | 14 x 75 |



| Precio € |  |
|----------|--|
| 2,45     |  |
| 2,45     |  |
| 2,45     |  |
| 2,45     |  |
| 2,75     |  |
| 3,35     |  |
|          |  |
| 2,75     |  |
| 2,75     |  |
| 2,75     |  |
| 2,75     |  |
| 2,75     |  |
| 3,50     |  |
| 3,98     |  |

**Puntas de 10 mm HEX**

| Refer:    | Medida  |
|-----------|---------|
| 2250/A-PR | 4 x 30  |
| 2251/A-PR | 5 x 30  |
| 2252/A-PR | 6 x 30  |
| 2253/A-PR | 7 x 30  |
| 2254/A-PR | 8 x 30  |
| 2255/A-PR | 10 x 30 |
| 2256/A-PR | 12 x 30 |
| 2257/A-PR | 14 x 30 |
|           |         |
| 2260/A-PR | 5 x 75  |
| 2261/A-PR | 6 x 75  |
| 2262/A-PR | 7 x 75  |
| 2263/A-PR | 8 x 75  |
| 2264/A-PR | 10 x 75 |
| 2265/A-PR | 12 x 75 |





| Precio € |  |
|----------|--|
| 2,45     |  |
| 2,45     |  |
| 2,45     |  |
| 2,45     |  |
| 2,45     |  |
| 2,45     |  |
| 2,75     |  |
| 2,90     |  |
|          |  |
| 2,75     |  |
| 2,75     |  |
| 2,75     |  |
| 2,75     |  |
| 2,90     |  |
| 4,38     |  |

**Puntas de 10 mm TORX INVIOLABLES**

| Refer:     | Medida  |   | Precio € |
|------------|---------|---|----------|
| 2825/A-PR  | 25 x 30 |    | 2,60     |
| 2827/A-PR  | 27 x 30 |   | 3,08     |
| 2830/A-PR  | 30 x 30 |   | 3,08     |
| 2840/A-PR  | 40 x 30 |   | 3,08     |
| 2845/A-PR  | 45 x 30 |   | 3,25     |
| 2850/A-PR  | 50 x 30 |   | 3,25     |
| 2855/A-PR  | 55 x 30 |   | 3,25     |
| 2860/A-PR  | 60 x 30 |   | 6,60     |
| 2881/A-PR  | 20 x 75 |   | 3,08     |
| 2881/1A-PR | 25 x 75 |   | 3,08     |
| 2882/A-PR  | 30 x 75 |   | 3,08     |
| 2883/A-PR  | 40 x 75 |   | 3,08     |
| 2884/A-PR  | 45 x 75 |   | 3,60     |
| 2885/A-PR  | 50 x 75 |   | 3,60     |
| 2886/A-PR  | 55 x 75 |   | 5,22     |
| 2887/A-PR  | 60 x 75 |   | 6,90     |
| 2888/A-PR  | 70 x 75 |   | 6,90     |

**Puntas de 10 mm RIBE**

| Refer:      | Medida  |  | Precio € |
|-------------|---------|--|----------|
| 18075/6-PR  | 6 x 75  |   | 3,10     |
| 18075/8-PR  | 8 x 75  |  | 3,10     |
| 18075/10-PR | 10 x 75 |  | 3,10     |
| 18075/12-PR | 12 x 75 |  | 4,82     |

**Vasos de 1/4" con puntas TORX**

| Refer:    | Medida  |  | Precio € |
|-----------|---------|--|----------|
| 2510/B-PR | 10 x 37 |   | 2,31     |
| 2515/B-PR | 15 x 37 |  | 2,31     |
| 2520/B-PR | 20 x 37 |  | 2,31     |
| 2525/B-PR | 25 x 37 |  | 2,31     |
| 2527/B-PR | 27 x 37 |  | 2,31     |
| 2530/B-PR | 30 x 37 |  | 2,31     |
| 2540/B-PR | 40 x 37 |  | 2,31     |

**Vasos de 1/4" con puntas ALLEN**

| Refer:    | Medida |  | Precio € |
|-----------|--------|--|----------|
| 2503/B-PR | 3 x 37 |   | 2,31     |
| 2504/B-PR | 4 x 37 |  | 2,31     |
| 2505/B-PR | 5 x 37 |  | 2,31     |
| 2506/B-PR | 6 x 37 |  | 2,31     |

**Vasos de 1/4" con puntas PH y PZ**

| Refer:    | Medida    |  | Precio € |
|-----------|-----------|--|----------|
| 257673-PR | PH-1 x 37 |   | 2,31     |
| 257674-PR | PH-2 x 37 |  | 2,31     |
| 257676-PR | PZ-1 x 37 |   | 2,31     |
| 257677-PR | PZ-2 x 37 |  | 2,31     |

**Puntas de atornillador de 1/4 x 25**
**Phillips**

|              |           |     |
|--------------|-----------|-----|
| 64000/10T-WH | PH-1 x 25 | TIN |
| 64010/10T-WH | PH-2 x 25 | "   |
| 64020/10T-WH | PH-3 x 25 | "   |



|    | Precio € |
|----|----------|
| 10 | 1,20     |
| 10 | 1,20     |
| 10 | 1,20     |

**Pozidrive**

|              |           |     |
|--------------|-----------|-----|
| 64100/10T-WH | PZ-1 x 25 | TIN |
| 64110/10T-WH | PZ-2 x 25 | "   |
| 64120/10T-WH | PZ-3 x 25 | "   |



|    |      |
|----|------|
| 10 | 1,20 |
| 10 | 1,20 |
| 10 | 1,20 |

**Phillips**

|             |           |
|-------------|-----------|
| 64000/10-WH | PH-1 x 25 |
| 64010/10-WH | PH-2 x 25 |
| 64020/10-WH | PH-3 x 25 |



|    |      |
|----|------|
| 10 | 0,65 |
| 10 | 0,65 |
| 10 | 0,65 |

**Pozydrive**

|             |           |
|-------------|-----------|
| 64100/10-WH | PZ-1 x 25 |
| 64110/10-WH | PZ-2 x 25 |
| 64120/10-WH | PZ-3 x 25 |
| 64130/10-WH | PZ-4 x 25 |



|    |      |
|----|------|
| 10 | 0,65 |
| 10 | 0,65 |
| 10 | 0,65 |
| 10 | 1,98 |

**Phillips**

|           |           |         |
|-----------|-----------|---------|
| R062/1-WH | PH-1 x 25 | Impacto |
| R062/2-WH | PH-2 x 25 | "       |



|   |      |
|---|------|
| 4 | 1,45 |
| 4 | 1,45 |

**Pozydrive**

|           |           |         |
|-----------|-----------|---------|
| R063/1-WH | PZ-1 x 25 | Impacto |
| R063/2-WH | PZ-2 x 25 | "       |



|   |      |
|---|------|
| 4 | 1,45 |
| 4 | 1,45 |



**Planas**

|           |                 |
|-----------|-----------------|
| 22/3-BIA  | Plana 3.0 x 0.5 |
| 22/4-BIA  | Plana 4.0 x 0.5 |
| 22/55-BIA | Plana 5.5 x 0.8 |
| 22/65-BIA | Plana 6.5 x 1.2 |





|    |      |
|----|------|
| 10 | 0,70 |
| 10 | 0,70 |
| 10 | 0,70 |
| 10 | 0,70 |



**Puntas de atornillador de 1/4 x 25**
**Hex**

|              |              |  |  |  | <b>Precio €</b> |
|--------------|--------------|---|--|---|-----------------|
| 3010/IN2-WH  | Hex 2 x 25   |   |  | 10  | 0,70            |
| 3010/IN25-WH | Hex 2.5 x 25 |   |  | 10  | 0,70            |
| 3010/IN3-WH  | Hex 3 x 25   |   |  | 10  | 0,70            |
| 3010/IN4-WH  | Hex 4 x 25   |   |  | 10  | 0,70            |
| 3010/IN5-WH  | Hex 5 x 25   |   |  | 10  | 0,70            |
| 3010/IN6-WH  | Hex 6 x 25   |   |  | 10  | 0,75            |
| 3010/IN8-WH  | Hex 8 x 25   |   |  | 10  | 1,90            |

**Torx Normales**

|              |           |  |  |  |      |
|--------------|-----------|---|--|---|------|
| 64040/T05-WH | T-05 x 25 |   |  | 10  | 1,10 |
| 64040/T06-WH | T-06 x 25 |   |  | 10  | 1,10 |
| 64040/T07-WH | T-07 x 25 |   |  | 10  | 1,10 |
| 64040/T08-WH | T-08 x 25 |   |  | 10  | 1,10 |
| 64040/T09-WH | T-09 x 25 |   |  | 10  | 1,10 |
| 64040/T10-WH | T-10 x 25 |   |  | 10  | 0,95 |
| 64040/T15-WH | T-15 x 25 |   |  | 10  | 0,95 |
| 64040/T20-WH | T-20 x 25 |   |  | 10  | 0,95 |
| 64040/T25-WH | T-25 x 25 |   |  | 10  | 0,95 |
| 64040/T27-WH | T-27 x 25 |   |  | 10  | 0,95 |
| 64040/T30-WH | T-30 x 25 |   |  | 10  | 0,95 |
| 64040/T40-WH | T-40 x 25 |   |  | 10  | 0,95 |

**Torx Inviolables**

|               |           |  |  |  |      |
|---------------|-----------|---|--|---|------|
| 64069/TX10-WH | T-10 x 25 |   |  | 10  | 1,75 |
| 64069/TX15-WH | T-15 x 25 |   |  | 10  | 1,75 |
| 64069/TX20-WH | T-20 x 25 |   |  | 10  | 1,75 |
| 64069/TX25-WH | T-25 x 25 |   |  | 10  | 1,75 |
| 64069/TX27-WH | T-27 x 25 |   |  | 10  | 1,75 |
| 64069/TX30-WH | T-30 x 25 |   |  | 10  | 1,75 |
| 64069/TX40-WH | T-40 x 25 |   |  | 10  | 1,75 |

**Cuadradas**

|             |                 |  |  |  |      |
|-------------|-----------------|---|--|---|------|
| 64040/C2-VO | Cuadrada 2 x 25 |   |  | 10  | 0,83 |

**Puntas de atornillador 1/4 x 50**
**Phillips**

|             |           |  |  |    |      |
|-------------|-----------|--|--|----|------|
| 64300/10-WH | PH-1 x 50 |  |  | 10 | 1,10 |
| 64310/10-WH | PH-2 x 50 |  |  | 10 | 1,10 |

**Pozydrive**

|             |           |  |  |    |      |
|-------------|-----------|--|--|----|------|
| 64350/10-WH | PZ-1 x 50 |  |  | 10 | 1,10 |
| 64360/10-WH | PZ-2 x 50 |  |  | 10 | 1,10 |

**Phillips**

|             |                   |  |  |   |      |
|-------------|-------------------|--|--|---|------|
| R062/150-WH | Impacto PH-1 x 50 |  |  | 2 | 2,19 |
| R062/250-WH | " PH-2 x 50       |  |  | 2 | 2,19 |

**Pozydrive**

|             |                   |  |  |   |      |
|-------------|-------------------|--|--|---|------|
| R063/150-WH | Impacto PZ-1 x 50 |  |  | 2 | 2,19 |
| R063/250-WH | " PZ-2 x 50       |  |  | 2 | 2,19 |

**Torx**

|               |           |  |  |    |      |
|---------------|-----------|--|--|----|------|
| 64110/T10-BIA | T-10 x 50 |  |  | 10 | 3,13 |
| 64115/T15-BIA | T-15 x 50 |  |  | 10 | 3,13 |
| 64120/T20-BIA | T-20 x 50 |  |  | 10 | 3,13 |
| 64125/T25-BIA | T-25 x 50 |  |  | 10 | 3,13 |

**Hex**

|              |                  |  |  |    |      |
|--------------|------------------|--|--|----|------|
| 4110/IN2-BIA | Hexagonal 2 x 50 |  |  | 10 | 1,92 |
|--------------|------------------|--|--|----|------|

**Puntas de atornillador 1/4 x 100**
**Refer:**

|           |            |  |  |   |      |
|-----------|------------|--|--|---|------|
| 64312-WH  | PH-1 x 100 |  |  | 5 | 5,24 |
| 64311-BIA | PH-2 x 100 |  |  | 5 | 5,24 |

|           |            |  |  |   |      |
|-----------|------------|--|--|---|------|
| 64351-WH  | PZ-1 x 100 |  |  | 5 | 5,24 |
| 64361-BIA | PZ-2 x 100 |  |  | 5 | 5,24 |

**Puntas de atornillador PH-2 con tope**
**Refer:**

|             |           |       |  |  |    |      |
|-------------|-----------|-------|--|--|----|------|
| 3006040-TOP | PH-2 x 25 | 2 uds |  |  | 10 | 4,16 |
|-------------|-----------|-------|--|--|----|------|

El tope metálico evita que el tornillo se embuta en la superficie atornillada sin dañarla.



**Puntas Mixtas de 1/4" x 25, 33 pzs.**

**Refer:**  
308-PR

Hex Inviolables: 5/32, 9/64, 1/8, 7/64, 3/32, 5/64

Hex Inviolables: 2, 2.5, 3, 4, 5, 6

Tri Wing: 1, 2, 3, 4

Torq Set: 6, 8, 10

Spanner: 4, 6, 8, 10

Torx Inviolable: T8, T10, T15, T20, T25, T27, T30, T35, T40

Adaptador magnético de 1/4" x 60 mm



**Precio €**  
8,08



**Vasos y Puntas Mixtas de 1/4" x 25, 24 pzs.**

**Refer:**  
101130-TOM

Planas: 4, 6

PH: 1, 2

PZ: 1, 2

Hex: 3, 4, 5, 6

Torx Inv: 10, 15, 20, 25, 30, 40

Llaves vaso 1/4": 6, 7, 8, 10, 11, 13

Adaptador magnético para puntas 1/4"

Adaptador 1/4" para llaves de vaso

Mini carraca reversible para puntas 1/4"



**Precio €**  
21,25



**Puntas Mixtas de 1/4" x 25, 32 pzs.**

**Refer:**  
101044-TOM

Planas: 4, 6

PH: 1, 2

PZ: 1, 2

Hex: 3, 4, 5, 6

Torx Inv: 10, 15, 20, 25, 30, 40

Adaptador magnético para puntas 1/4"

Adaptador 1/4" para llaves de vaso



**Precio €**  
16,38







**Adaptador Magnético de 1/4"**

| Refer:   | ↔      | Precio € |
|----------|--------|----------|
| 64201-WH | 60 mm  | 2,20     |
| 64200-WH | 100 mm | 3,95     |



**Adaptador Magnético de 1/4" Impacto**

| Refer:  | ↔     | Precio € |
|---------|-------|----------|
| R067-WH | 60 mm | 5,52     |



**Adaptador Magnético de 1/4" SDS**

| Refer:    | ↔     | Precio € |
|-----------|-------|----------|
| 64202-TOM | 75 mm | 5,36     |



**Adaptador Magnético de 1/4"**

| Refer:      | ↔     | Precio € |
|-------------|-------|----------|
| 3006071-TOP | 60 mm | 9,45     |

*Regulable*



**Adaptadores Magnéticos de 1/4"**

| Refer:      | ↔      | Precio € |
|-------------|--------|----------|
| 3006072-TOP | 150 mm | 17,24    |
| 3006073-TOP | 300 mm | 21,26    |



**Adaptador Magnético Flexible de 1/4"**

| Refer:    | ↔      | Precio € |
|-----------|--------|----------|
| 967217-WH | 300 mm | 11,48    |

### Adaptadores Magnéticos Hexagonales

| Refer:     | Medida          |          | Precio € |
|------------|-----------------|----------|----------|
| 64400-VO   | 1/4 x 50 (6.35) | Sin Imán | 3,57     |
| 64420-VO   | 3/8 x 50 (9.52) | Sin Imán | 3,57     |
| 64451-WH   | 1/4 x 65 (6.35) |          | 4,49     |
| 1501-YT    | 6 x 50 x 1/4    |          | 2,21     |
| 1502-YT    | 7 x 50 x 1/4    |          | 2,21     |
| 1503-YT    | 8 x 50 x 1/4    |          | 2,21     |
| 64531/B-WH | 8 x 65 x 1/4    | Blíster  | 4,70     |
| 1505-YT    | 10 x 50 x 1/4   |          | 2,37     |
| 64540/B-WH | 10 x 65 x 1/4   | Blíster  | 4,70     |
| 1507-YT    | 12 x 50 x 1/4   |          | 3,55     |
| 64542-WH   | 12 x 65 x 1/4   |          | 4,49     |
| 1508-YT    | 13 x 50 x 1/4   |          | 3,78     |
| 64543/B-WH | 13 x 65 x 1/4   | Blíster  | 4,99     |
| 1510-YT    | 17 x 65 x 1/4   |          | 5,10     |

### Juego de Adaptadores Magnéticos, 5 pzs.

**Refer:** 1500-TOM **Precio €** 9,80

Medidas: 7 - 8 - 10 - 12 - 13 mm x 65 mm

### Adaptador Hembra - Hembra 1/4 x 1/4

**Refer:** 20624-PR    25 mm **Precio €** 1,53

Para uso con carraca de 1/4" y puntas de atornillador

**Juego de Adaptadores de 1/4", 3 pzs.**

**Refer:**  
4703-TOM

**Precio €**  
4,69

Para llaves de vaso de: 1/4", 3/8" y 1/2"

**Juego de Adaptadores Sds Plus, 3 pzs.**

**Refer:**  
550743

**Precio €**  
5,81

Para llaves de vaso de: 1/4", 3/8" y 1/2"

**Adaptadores 1/4" Portavasos 1/4", 2 pzs.**

**Refer:**  
20626-TOM  
20627-TOM

**Precio €**  
2,86  
3,74

Blister con 2 uds

**Adaptador 1/4" Portavasos 1/2"**

**Refer:**  
56H556

**Precio €**  
3,88

Blister con 2 uds

**Tornillo Tirafondo tipo Barraquero Cincado**

| <u>Refer:</u> | <u>Medida</u> |  | <u>Precio €</u> |
|---------------|---------------|---|-----------------|
|               |               |   | <u>Caja</u>     |
| 695030Z-VO    | 5 x 30        | 100   | 4,10            |
| 695040Z-VO    | 5 x 40        | 100   | 4,98            |
| 696040Z-VO    | 6 x 40        | 200   | 11,96           |
| 696050Z-VO    | 6 x 50        | 200   | 13,94           |
| 696060Z-VO    | 6 x 60        | 200   | 15,12           |
| 696070Z-VO    | 6 x 70        | 100   | 11,72           |
| 696080Z-VO    | 6 x 80        | 100   | 11,95           |
| 697040Z-VO    | 7 x 40        | 100   | 9,48            |
| 697050Z-VO    | 7 x 50        | 100   | 9,99            |
| 697060Z-VO    | 7 x 60        | 100   | 11,92           |
| 697070Z-VO    | 7 x 70        | 100   | 12,10           |
| 697080Z-VO    | 7 x 80        | 100   | 16,36           |
| 698040Z-VO    | 8 x 40        | 100   | 10,50           |
| 698050Z-VO    | 8 x 50        | 100   | 12,94           |
| 698060Z-VO    | 8 x 60        | 100   | 13,75           |
| 698070Z-VO    | 8 x 70        | 100   | 16,58           |
| 698080Z-VO    | 8 x 80        | 100   | 18,14           |
| 698090Z-VO    | 8 x 90        | 100   | 19,04           |
| 6980100Z-VO   | 8 x 100       | 50  | 10,98           |
| 6980120Z-VO   | 8 x 120       | 50  | 13,96           |
| 691060Z-VO    | 10 x 60       | 50  | 15,65           |
| 691070Z-VO    | 10 x 70       | 50  | 16,71           |
| 691080Z-VO    | 10 x 80       | 50  | 17,17           |
| 6910100Z-VO   | 10 x 100      | 50  | 18,30           |
| 6910120Z-VO   | 10 x 120      | 50  | 19,15           |



**DIN 571**

**Tornillo Rapid Lastro cabeza ALOMADA Phillips con punta de broca Cincado**

| <u>Refer:</u> | <u>Medida</u> |  | <u>Precio €</u> |
|---------------|---------------|---|-----------------|
|               |               |   | <u>Caja</u>     |
| 724213/Z-VO   | 4,2 x 13      | 500   | 10,53           |
| 724219/Z-VO   | 4,2 x 19      | 500   | 16,24           |
| 724225/Z-VO   | 4,2 x 25      | 500   | 17,40           |



**Tornillo Rosca Madera cabeza ALOMADA Pozidrive Cincado**

| <u>Refer:</u> | <u>Medida</u> |  | <u>Precio €</u> |             |
|---------------|---------------|---|-----------------|-------------|
|               |               |   |                 | <u>Caja</u> |
| 643016/Z-VO   | 3 x 16        | 200   |                 | 4,33        |
| 643020/Z-VO   | 3 x 20        | 200   |                 | 4,99        |
| 644030/Z-VO   | 4 x 30        | 200   |                 | 6,27        |
| 644040/Z-VO   | 4 x 40        | 200   |                 | 7,33        |
| 644530/Z-VO   | 4,5 x 30      | 200   |                 | 9,48        |
| 644535/Z-VO   | 4,5 x 35      | 200   |                 | 11,43       |
| 644540/Z-VO   | 4,5 x 40      | 200   |                 | 12,77       |
| 645050/Z-VO   | 5 x 50        | 200   |                 | 17,31       |

**Tornillo auto taladrante cabeza ALOMADA Phillips con punta de broca Cincado**

| <u>Refer:</u>  | <u>Medida</u> |  |          | <u>Precio €</u> |             |
|----------------|---------------|---|----------|-----------------|-------------|
|                |               |   |          |                 | <u>Caja</u> |
| 743595/500Z-VO | 3,5 x 9,5     | 500   | Cuadrada | 4,10            |             |
| 743513/Z-VO    | 3,5 x 13      | 1000  |          | 14,93           |             |
| 743516/Z-VO    | 3,5 x 16      | 1000  |          | 18,95           |             |
| 744216/Z-VO    | 4,2 x 16      | 1000  |          | 21,34           |             |
| 744219/Z-VO    | 4,2 x 19      | 1000  |          | 22,66           |             |
| 744225/Z-VO    | 4,2 x 25      | 500   |          | 12,23           |             |
| 744232/Z-VO    | 4,2 x 32      | 1000  |          | 33,70           |             |
| 744819/500Z-VO | 4,8 x 19      | 500   | Cuadrada | 7,98            |             |
| 744819/Z-VO    | 4,8 x 19      | 1000  |          | 28,50           |             |
| 744825/Z-VO    | 4,8 x 25      | 1000  |          | 39,85           |             |
| 744832/ZQ-VO   | 4,8 x 32      | 500   |          | 21,32           |             |
| 744838/ZQ-VO   | 4,8 x 38      | 500   |          | 24,22           |             |
| 744845/ZQ-VO   | 4,8 x 45      | 500   |          | 26,70           |             |
| 7448100/Z-VO   | 4,8 x 100     | 100   |          | 15,92           |             |

**DIN 7504-N**
**Tornillo auto taladrante cabeza PLANA Phillips con punta de broca Cincado**

| <u>Refer:</u> | <u>Medida</u> |  | <u>Precio €</u> |             |
|---------------|---------------|---|-----------------|-------------|
|               |               |   |                 | <u>Caja</u> |
| 753513/Z-VO   | 3,5 x 13      | 1000  |                 | 12,45       |
| 753516/Z-VO   | 3,5 x 16      | 1000  |                 | 13,34       |
| 753519/Z-VO   | 3,5 x 19      | 1000  |                 | 16,20       |
| 753525/Z-VO   | 3,5 x 25      | 500   |                 | 8,66        |
| 754213/Z-VO   | 4,2 x 13      | 1000  |                 | 17,99       |
| 754216/Z-VO   | 4,2 x 16      | 1000  |                 | 17,31       |
| 754219/Z-VO   | 4,2 x 19      | 1000  |                 | 21,46       |
| 754225/Z-VO   | 4,2 x 25      | 500   |                 | 13,20       |
| 754232/ZQ-VO  | 4,2 x 32      | 500   |                 | 15,25       |
| 754819/Z-VO   | 4,8 x 19      | 1000  |                 | 28,50       |
| 754825/Z-VO   | 4,8 x 25      | 500   |                 | 15,47       |
| 754832/ZQ-VO  | 4,8 x 32      | 500   |                 | 20,04       |
| 754838/Z-VO   | 4,8 x 38      | 500   |                 | 22,04       |
| 754845/ZQ-VO  | 4,8 x 45      | 500   |                 | 29,00       |

**DIN 7504-P**

**Tornillo Autotaladrante Cabeza Hexagonal + Arandela EPDM**

| <u>Refer:</u> | <u>Medida</u> |  | <u>Precio €</u> |  |
|---------------|---------------|---|-----------------|--|
|               |               |   | <u>Caja</u>     |  |
| 734819/ZQ-VO  | 4,8 x 19      | 1000  | 52,08           |  |
| 734825/ZQ-VO  | 4,8 x 25      | 1000  | 64,59           |  |
| 735522/ZQ-VO  | 5,5 x 22      | 1000  | 67,94           |  |
| 735525/ZQ-VO  | 5,5 x 25      | 1000  | 70,03           |  |
| 735532/ZQ-VO  | 5,5 x 32      | 1000  | 78,18           |  |
| 735550/ZD-VO  | 5,5 x 50      | 500   | 52,70           |  |
| 735563-VO     | 5,5 x 63      | 250   | 33,27           |  |
| 736350-TOM    | 6,3 x 50      | 250   | 34,36           |  |
| 736375-VO     | 6,3 x 75      | 250   | 46,86           |  |
| 7363100-VO    | 6,3 x 100     | 100   | 30,07           |  |
| 7363120-VO    | 6,3 x 120     | 100   | 37,67           |  |

**DIN 7504-K**
**Arandela EPDM de Acero Galvanizado**

| <u>Refer:</u> | <u>Medida</u> |  | <u>Precio €</u> |  |
|---------------|---------------|---|-----------------|--|
|               |               |   | <u>Caja</u>     |  |
| 714814-TOM    | P14 x 4,8     | 500   | 15,50           |  |
| 715516-TOM    | P16 x 5,5     | 500   | 16,07           |  |
| 716318-TOM    | P18 x 6,3     | 500   | 18,11           |  |
| 716325-TOM    | P25 x 6,3     | 500   | 36,96           |  |

**DIN 7711**
**Tornillo Fosfatado para "Pladur" con rosca normal**

| <u>Refer:</u> | <u>Medida</u> |  | <u>Precio €</u> |  |
|---------------|---------------|---|-----------------|--|
|               |               |   | <u>Caja</u>     |  |
| 653625/F-VO   | 3,6 x 25      | 1000  | 15,40           |  |
| 653635/F-VO   | 3,6 x 35      | 1000  | 18,69           |  |
| 653645/F-VO   | 3,6 x 45      | 500   | 11,44           |  |
| 653655/F-VO   | 3,6 x 55      | 500   | 14,14           |  |



**Tornillos Rosca Madera con cabeza Pozidrive Bicromatado**
**Refer:**

66...

| Medida   |        | € Caja |
|----------|--------|--------|
| 2,6 x 12 | 1000   | 9,73   |
| 2,6 x 16 | 1000   | 9,95   |
| 3 x 12   | 200    | 2,70   |
| 3 x 16   | 200    | 2,93   |
| 3x16x0,5 | 200    | 2,70   |
| 3 x 20   | 200    | 2,84   |
| 3 x 25   | 200    | 3,62   |
| 3 x 30   | 200    | 4,16   |
| 3 x 35   | 200    | 4,40   |
| 3 x 40   | 200    | 4,93   |
| 3,5 x 12 | 200    | 3,16   |
| 3,5 x 16 | 200    | 3,02   |
| 3,5 x 20 | 200    | 3,27   |
| 3,5 x 25 | 200    | 3,67   |
| 3,5 x 30 | 200    | 4,15   |
| 3,5 x 30 | 200 TX | 4,15   |
| 3,5 x 35 | 200    | 4,62   |
| 3,5 x 40 | 200    | 5,58   |
| 3,5 x 45 | 200    | 6,22   |
| 3,5 x 50 | 200    | 6,86   |

| Medida   |     | € Caja |
|----------|-----|--------|
| 4 x 16   | 200 | 3,59   |
| 4 x 20   | 200 | 3,59   |
| 4 x 25   | 200 | 3,98   |
| 4 x 30   | 200 | 4,07   |
| 4 x 35   | 200 | 5,02   |
| 4 x 40   | 200 | 5,34   |
| 4 x 45   | 200 | 6,53   |
| 4 x 50   | 200 | 6,77   |
| 4 x 60   | 200 | 8,77   |
| 4 x 70   | 200 | 10,68  |
| 4,5 x 16 | 200 | 5,05   |
| 4,5 x 20 | 200 | 5,27   |
| 4,5 x 25 | 200 | 5,75   |
| 4,5 x 30 | 200 | 5,90   |
| 4,5 x 35 | 200 | 6,70   |
| 4,5 x 40 | 200 | 6,86   |
| 4,5 x 45 | 200 | 7,65   |
| 4,5 x 50 | 200 | 8,53   |
| 4,5 x 60 | 200 | 10,13  |
| 4,5 x 70 | 200 | 14,50  |
| 4,5 x 80 | 200 | 19,13  |

| Medida  |     | € Caja |
|---------|-----|--------|
| 5 x 20  | 200 | 6,05   |
| 5 x 25  | 200 | 6,20   |
| 5 x 30  | 200 | 6,62   |
| 5 x 35  | 200 | 7,34   |
| 5 x 40  | 200 | 8,21   |
| 5 x 45  | 200 | 9,25   |
| 5 x 50  | 200 | 9,63   |
| 5 x 60  | 200 | 11,28  |
| 5 x 70  | 200 | 13,42  |
| 5 x 80  | 200 | 15,90  |
| 5 x 90  | 200 | 22,23  |
| 5 x 100 | 200 | 25,53  |
| 6 x 30  | 100 | 6,33   |
| 6 x 40  | 100 | 6,47   |
| 6 x 50  | 100 | 7,45   |
| 6 x 60  | 100 | 9,06   |
| 6 x 70  | 100 | 10,62  |
| 6 x 80  | 100 | 12,31  |
| 6 x 90  | 100 | 15,65  |
| 6 x 100 | 100 | 15,45  |
| 6 x 110 | 100 | 19,84  |
| 6 x 120 | 100 | 18,78  |
| 6 x 130 | 100 | 25,48  |
| 6 x 140 | 100 | 27,79  |
| 6 x 150 | 100 | 34,21  |
| 6 x 160 | 100 | 39,24  |
| 6 x 180 | 100 | 56,24  |
| 6 x 200 | 100 | 71,06  |

**DIN 7505-A**
**Tornillos de Media Rosca para Madera con cabeza Pozidrive Bicromatado**
**Refer:**

| Refer:       | Medida      |      | € Caja |
|--------------|-------------|------|--------|
| 684040/MB-VO | 4 x 40/24   | 1000 | 23,00  |
| 684050/QB-VO | 4 x 50/30   | 500  | 14,65  |
| 684550/QB-VO | 4,5 x 50/30 | 500  | 17,87  |
| 684560/QB-VO | 4,5 x 60/36 | 500  | 21,80  |

**DIN 7505-A**

**Destornilladores Extra Largos**



| Refer:     | Tipo Varilla x Largo Varilla x Largo Total |  | Precio € |
|------------|--|--|----------|
| 384503-WH  | Plana 6,5 x 1.2 mm x 400 x 510             |  | 11,51    |
| 3845061-WH | Phillips PH-2 x 400 x 510                  |  | 11,51    |



**Destornillador 1/4" Flexible**

| Refer:    | Dimensiones      |  | Precio € |
|-----------|------------------|--|----------|
| 1719/3-WH | 1/4" x 160 x 270 |  | 7,65     |

Cuadradillo para vasos de 1/4"



**Destornillador 1/4" Mango Recto**

| Refer:   | Dimensiones     |  | Precio € |
|----------|-----------------|--|----------|
| 21117-PR | 1/4" x 60 x 150 |  | 3,98     |

Cuadradillo para vasos de 1/4"



**Juego Destornillador 1/4" Flexible con Puntas y Vasos, 31 pzs.**

| Refer:       |                                      |  | Precio € |
|--------------|--------------------------------------|--|----------|
| 3039D865-TOP | Inserción hembra para puntas de 1/4" |  | 16,90    |







**Destornillador Porta-puntas de 1/4" magnético Eco**

|                               |   |                             |   |   |                         |
|-------------------------------|---|-----------------------------|---|---|-------------------------|
| <b>Refer:</b><br>3039D860-TOP | <u>Varilla x largo</u><br>1/4 x 100 x 215 | Mango ergonómico bimaterial |  | <br>12 | <b>Precio €</b><br>3,28 |
|-------------------------------|---|-----------------------------|---|---|-------------------------|



**Destornillador Porta-puntas de 1/4" magnético Pro**

|                            |   |                             |   |   |                         |
|----------------------------|---|-----------------------------|---|---|-------------------------|
| <b>Refer:</b><br>961173-WH | <u>Tipo de Varilla</u><br>1/4 x 100 x 210 | Mango ergonómico bimaterial |  | <br>10 | <b>Precio €</b><br>7,56 |
|----------------------------|---|-----------------------------|---|---|-------------------------|



**Destornillador Porta-puntas Corto de 1/4" magnético**

|                            |  |                             |   |   |                         |
|----------------------------|--|-----------------------------|---|---|-------------------------|
| <b>Refer:</b><br>1717/5-WH | <u>Tipo de Varilla</u><br>1/4 x 38 x 118 | Mango ergonómico bimaterial |  | <br>10 | <b>Precio €</b><br>9,99 |
|----------------------------|--|-----------------------------|---|---|-------------------------|

**Destornillador Portavasos y Puntas 1/4" (2 en 1)**

|                           |                          |
|---------------------------|--------------------------|
| <b>Refer:</b><br>16124-WH | <b>Precio €</b><br>10,48 |
|---------------------------|--------------------------|



  
10

**Destornilladores de Vaso HEXAGONAL mango recto**



| <u>Refer:</u> | <u>Medida x Largo</u> | <u>Precio €</u> | <u>Refer:</u> | <u>Medida x Largo</u> | <u>Precio €</u> |
|---------------|-----------------------|-----------------|---------------|-----------------------|-----------------|
| 216/4-WH      | Vaso de 4 x 210 mm    | 6,95            | 216/9-WH      | Vaso de 9 x 235 mm    | 9,50            |
| 216/45-ELO    | Vaso de 4.5 x 210 mm  | 6,95            | 216/10-WH     | Vaso de 10 x 245 mm   | 9,60            |
| 216/5-WH      | Vaso de 5 x 225 mm    | 7,10            | 216/11-WH     | Vaso de 11 x 245 mm   | 9,75            |
| 216/55-WH     | Vaso de 5.5 x 225 mm  | 7,10            | 216/12-WH     | Vaso de 12 x 245 mm   | 9,95            |
| 216/6-WH      | Vaso de 6 x 235 mm    | 7,36            | 216/13-WH     | Vaso de 13 x 245 mm   | 10,30           |
| 216/7-WH      | Vaso de 7 x 235 mm    | 7,66            | 216/14-WH     | Vaso de 14 x 245 mm   | 10,65           |
| 216/8-WH      | Vaso de 8 x 235 mm    | 7,87            | 216/1/4-ELO   | Vaso de 1/4" x 210 mm | 6,44            |

**Destornillador Reversible Profesional 6 en 1**



Refer:  
968602-WH

Precio €  
13,76



Ph 1-2-3



Plano 4-5-6



**Destornillador Carrocero Portapuntas 1/4"**



Refer:  
968808-WH

Precio €  
7,76



Pz 1-2-3



Ph 1-2-3



Plano 6,5





**Destornilladores ALLEN mango "T"**

| Refer:       | Hexagonal               | Precio € |
|--------------|-------------------------|----------|
| 156/H025-FLY | Varilla 2,5 mm x 100 mm | 5,32     |
| 156/H03-FLY  | Varilla 3 mm x 100 mm   | 5,72     |
| 156/H04-FLY  | Varilla 4 mm x 150 mm   | 6,05     |
| 156/H05-FLY  | Varilla 5 mm x 150 mm   | 6,44     |
| 156/H06-FLY  | Varilla 6 mm x 150 mm   | 7,26     |
| 156/H08-FLY  | Varilla 8 mm x 200 mm   | 8,35     |



**Destornilladores ALLEN BOLA mango "T"**

| Refer:       | Hexagonal con BOLA    | Precio € |
|--------------|-----------------------|----------|
| 157/HB03-FLY | Varilla 3 mm x 100 mm | 5,83     |
| 157/HB04-FLY | Varilla 4 mm x 150 mm | 6,22     |
| 157/HB05-FLY | Varilla 5 mm x 150 mm | 6,60     |
| 157/HB06-FLY | Varilla 6 mm x 150 mm | 7,76     |



**Destornillador Reversible doble boca "profesional"**

**Refer:** 3039D516-TOP **Precio €** 7,93

Con dos puntas dobles: PH-1 x PH-2  
PL-5 x PL-6



**Destornilladores mango "T" varilla INVIOLEBLE + varilla larga NORMAL**

| Refer:       | Varilla x largo   | Precio € |
|--------------|-------------------|----------|
| 762/TI09-FLY | Varilla 09x100x12 | 6,56     |
| 762/TI10-FLY | Varilla 10x100x12 | 6,56     |
| 762/TI15-FLY | Varilla 15x100x12 | 6,56     |
| 762/TI20-FLY | Varilla 20x100x12 | 6,56     |
| 762/TI25-FLY | Varilla 25x150x14 | 7,98     |
| 762/TI27-FLY | Varilla 27x150x14 | 7,98     |
| 762/TI30-FLY | Varilla 30x150x14 | 7,98     |



**Destornilladores TORX mango "T"**

| Refer:       | Varilla x largo    | Precio € |
|--------------|--------------------|----------|
| 762/TX30-ELO | Varilla T-30 x 125 | 7,07     |
| 762/TX45-ELO | Varilla T-45 x 125 | 10,19    |
| 762/TX50-ELO | Varilla T-50 x 125 | 11,02    |

*Hasta fin de existencias*



**Destornilladores XZN mango "T"**

| Refer:        | Varilla x largo  | Precio € |
|---------------|------------------|----------|
| 158/XZN04-FLY | Varilla 4 x 100  | 7,02     |
| 158/XZN05-FLY | Varilla 5 x 100  | 7,74     |
| 158/XZN06-FLY | Varilla 6 x 100  | 7,74     |
| 158/XZN08-FLY | Varilla 8 x 150  | 9,18     |
| 158/XZN10-FLY | Varilla 10 x 150 | 12,12    |



**Destor TORX Inviolable mango "T"**

| Refer:       | Varilla x largo  | Precio € |
|--------------|------------------|----------|
| 764/TI09-FLY | Varilla 09 x 100 | 7,02     |
| 764/TI10-FLY | Varilla 10 x 100 | 7,02     |
| 764/TI15-FLY | Varilla 15 x 100 | 7,02     |
| 764/TI20-FLY | Varilla 20 x 100 | 7,06     |
| 764/TI25-FLY | Varilla 25 x 100 | 7,74     |
| 764/TI27-FLY | Varilla 27 x 100 | 7,74     |
| 764/TI30-FLY | Varilla 30 x 100 | 7,74     |
| 764/TI40-FLY | Varilla 40 x 100 | 8,64     |



**Destornilladores TORX mango recto**

Tools that work for you

| Refer:       |  | Medida           | Marca |    | Precio € |
|--------------|--|------------------|-------|----|----------|
| 760/TX25-ELO |  | T-25 x 100 x 207 | Wiha  | 10 | 5,64     |
| 760/TX27-ELO |  | T-27 x 115 x 200 | Elora | 6  | 4,78     |
| 760/TX30-ELO |  | T-30 x 115 x 200 | Elora | 6  | 4,95     |
| 760/TX40-ELO |  | T-40 x 130 x 235 | Elora | 6  | 7,15     |
| 760/TX45-ELO |  | T-45 x 130 x 235 | Elora | 6  | 7,67     |

**Destornilladores TORX Inviolable Mango Bi-Material**

| Refer:       |  | Medida     |    | Precio € |
|--------------|--|------------|----|----------|
| 1374/T05I-WH |  | T-5 x 60   | 10 | 3,60     |
| 1374/T06I-WH |  | T-6 x 60   | 10 | 3,70     |
| 1374/T07I-WH |  | T-7 x 60   | 10 | 3,85     |
| 1374/T08I-WH |  | T-8 x 60   | 10 | 3,90     |
| 1374/T09I-WH |  | T-9 x 60   | 10 | 3,95     |
| 1374/T10I-WH |  | T-10 x 80  | 10 | 4,00     |
| 1374/T15I-WH |  | T-15 x 80  | 10 | 4,05     |
| 1374/T20I-WH |  | T-20 x 100 | 10 | 4,10     |
| 1374/T25I-WH |  | T-25 x 100 | 10 | 4,20     |
| 1374/T30I-WH |  | T-30 x 115 | 10 | 4,75     |
| 1374/T40I-WH |  | T-40 x 130 | 10 | 5,95     |

**Destornillador de GOLPE con 6 puntas**

Refer: 224/4-PR 8 y 10 Cortas **Precio €**  
10 Larga 20,24

**Condor**  
Werkzeug 2 y 3 Cortas  
3 Larga

**Puntas 6 pzs**

Refer: 224/B-PR **Precio €**  
4,23



**Mini-Destornilladores Mixtos, 6 pzs**

|                             |   |                         |
|-----------------------------|---|-------------------------|
| <b>Refer:</b><br>3164553-YT | <b>Medidas</b><br>1.4, 2.4, 3, Ph1, Ph0, Ph00 | <b>Precio €</b><br>8,68 |
|-----------------------------|---|-------------------------|





**Mini-Destornilladores Torx, 6 pzs**

|                             |   |                         |
|-----------------------------|---|-------------------------|
| <b>Refer:</b><br>3164554-YT | <b>Medidas</b><br>Tx5, Tx6, Tx7, Tx8, Tx9, Tx10 | <b>Precio €</b><br>8,25 |
|-----------------------------|---|-------------------------|



**Destornillador en "T" con Vasos y Puntas, 21 pzs**

|                           |                         |
|---------------------------|-------------------------|
| <b>Refer:</b><br>65100-YT | <b>Precio €</b><br>4,59 |
|---------------------------|-------------------------|

-  5, 6, 7, 8, 9, 10, 11, 12, 13 mm
-  3, 4, 5, 6, 8 mm
-  PH1, PH2, PH3
-  T15, T20, T30



10

**Destornilladores PZ y PH**

| <u>Refer:</u> | <u>Varilla</u> | <u>Pala / Varilla / Total</u> |  |    | <u>Precio €</u> |
|---------------|----------------|-------------------------------|--|----|-----------------|
| 3039D830-TOP  | Pozydrive      | PZ 1 x 100 x 200              |  | 12 | 2,58            |
| 3039D831-TOP  | Pozydrive      | PZ 2 x 100 x 210              |  |    | 3,14            |
| 3039D820-TOP  | Phillips       | PH 0 x 75 x 165               |  | 12 | 2,00            |
| 3039D821-TOP  | Phillips       | PH 1 x 100 x 200              |  |    | 2,50            |
| 3039D823-TOP  | Phillips       | PH 2 x 100 x 210              |  |    | 3,14            |
| 3039D825-TOP  | Phillips       | PH 3 x 150 x 270              |  |    | 3,85            |

**Destornilladores Planos**

| <u>Refer:</u> | <u>Varilla</u> | <u>Pala / Varilla / Total</u> |  |    | <u>Precio €</u> |
|---------------|----------------|-------------------------------|--|----|-----------------|
| 3039D801-TOP  | Plana          | 3,2 x 75 x 165                |  | 12 | 2,00            |
| 3039D802-TOP  | Plana          | 4 x 100 x 190                 |  |    | 2,42            |
| 3039D804-TOP  | Plana          | 5 x 100 x 200                 |  |    | 2,58            |
| 3039D806-TOP  | Plana          | 6,5 x 150 x 260               |  |    | 3,25            |

**Destornilladores de Carrocero**

| <u>Refer:</u> | <u>Tipo de Varilla</u> |    |  | <u>Precio €</u> |
|---------------|------------------------|----|--|-----------------|
| 3039D803-TOP  | Plana 5 x 38           | 12 |  | 2,59            |



| <u>Refer:</u> | <u>Tipo de Varilla</u> |    |  | <u>Precio €</u> |
|---------------|------------------------|----|--|-----------------|
| 3039D822-TOP  | PH 2 x 38              | 12 |  | 2,28            |

**Juego Destor. Ph - Planos, 6 pzs.**

**Refer:** 3039D886-TOP **Precio €** 17,01

- Destor Plano 5 x 38
- Destor Plano 5 x 100
- Destor Plano 6,5 x 150
- Destor PH 1 x 100
- Destor PH 2 x 38
- Destor PH 2 x 150

**Destornilladores Aislados**

| Refer:       | Varilla | Pala / Varilla / Espesor |       | 📦  | Precio € |
|--------------|---------|--------------------------|-------|----|----------|
| 3039D470-TOP | Plana   | 2,5 x 75 x 0,4           | Topex | 12 | 3,31     |
| 3039D471-TOP | Plana   | 3 x 100 x 0,6            | Topex | 12 | 3,39     |
| 3039D472-TOP | Plana   | 4 x 100 x 0,8            | Topex | 12 | 4,29     |
| 3039D473-TOP | Plana   | 5,5 x 125 x 1,0          | Topex | 12 | 6,71     |

**Destornilladores Aislados**

| Refer:       | Varilla  | Pala / Varilla / Total |            | 📦  | Precio € |
|--------------|----------|------------------------|------------|----|----------|
| 3039D475-TOP | Phillips | PH 0 x 60 x 150        | Topex      | 12 | 3,24     |
| 3039D476-TOP | Phillips | PH 1 x 80 x 195        | Topex      | 12 | 4,47     |
| 3039D477-TOP | Phillips | PH 2 x 100 x 220       | Topex      | 12 | 6,32     |
| 1522/3150-WH | Phillips | PH 3 x 150 x 270       | Whirlpower | 10 | 6,07     |





**Soldador a gas Butano**

**Refer:**  
129/70-FLY

Temperatura de la punta: 210-450° C.  
 Peso a capacidad total: 76 grs.  
 Antorcha: 1300° C.

*Encendido Manual*

Capacidad del depósito: 20 ml.  
 Tiempo operativo: 120 min a medio gas.  
**Fácilmente recargable con gas Butano**



**Precio €**  
37,44



**Soldador Eléctrico**

**Refer:**  
3044E024-TOP

**Potencia**  
40 W

**Tipo**  
Punta Pico

Certificacion CE  
Voltage: 230

**Precio €**  
14,05



**Portabrocas Angular 90° para Taladro**

**Refer:**  
3055H932

**Ø**  
0,8 mm - 10 mm

**Precio €**  
35,95

Cogida hexagonal de 8 mm  
Para uso con atornilladores a batería y taladros eléctricos.  
Con giro a derecha e izquierda.  
Permite trabajar en zonas de difícil acceso.



**Adaptador Angular para puntas de 1/4"**

**Refer:**  
3055H931

**Precio €**  
21,07

Permite atornillado con ángulo a 90°.  
Para uso con atornilladores a batería y taladros eléctricos.  
Equipado con transmisión de rodamiento de bolas.

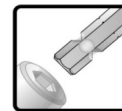

**Adaptador Sds Max a Sds Plus**

**Refer:**  
7030-TOM

**Precio €**  
25,72

Permite trabajar con útiles Sds Plus en martillos Sds Max.



**Tuerca Ajuste Rápido M14**

**Refer:**  
4160-TOM

**Precio €**  
14,63

Permite ajustar manualmente los discos en la amoladora

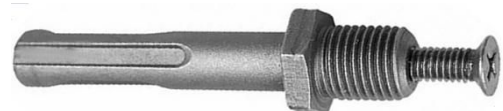

**Adaptador SDS Plus a 1/2" x 20 UNF**

**Refer:**  
4140-TOM

**Precio €**  
2,85

Acople de portabrocas en taladros sds plus



**Llaves para Taladro**

| Refer:     | Ø         | Precio € |
|------------|-----------|----------|
| 4071/1-TOM | 1 - 10 mm | 1,15     |
| 4072-TOM   | 1 - 13 mm | 1,49     |
| 4073-TOM   | 1 - 16 mm | 1,95     |



**Portabrocas Rápido Mini Hex 1/4"**

| Refer:   | Ø               | Precio € |
|----------|-----------------|----------|
| 4180-TOM | 0,5 mm - 6,5 mm | 10,47    |



**Portabrocas 13 mm Automático**

| Refer:     | Ø             | Precio € |
|------------|---------------|----------|
| 4100/B-TOM | 1/2" x 20 UNF | 7,90     |



**Portabrocas 13 mm + Llave Taladro + Adap Sds**

| Refer:     | Ø             | Precio € |
|------------|---------------|----------|
| 4070/3-TOM | 1/2" x 20 UNF | 9,91     |



**Portabrocas 13 mm + Llave Taladro**

| Refer:   | Ø             | Precio € |
|----------|---------------|----------|
| 4070-TOM | 1/2" x 20 UNF | 6,96     |



**Portabrocas Metálico + Adap Sds Plus**

| Refer:   | Ø             | Precio € |
|----------|---------------|----------|
| 4080-TOM | 1/2" x 20 UNF | 23,01    |



**Portabrocas Metálico Profesional**

| Refer:   | Ø             | Precio € |
|----------|---------------|----------|
| 4050-TOM | 1/2" x 20 UNF | 19,55    |



**Formones con mango de plástico**

| Refer:       | Medidas | Precio € |
|--------------|---------|----------|
| 3009A108-TOP | 8 mm    | 3,82     |
| 3009A110-TOP | 10 mm   | 3,94     |
| 3009A112-TOP | 12 mm   | 4,09     |
| 3009A115-TOP | 15 mm   | 4,41     |
| 3009A120-TOP | 20 mm   | 5,03     |
| 3009A125-TOP | 25 mm   | 4,86     |



mm  
250



10



**Escofinas para Madera M/ Bimaterial**

| Refer:       |            |   | Precio € |
|--------------|------------|---|----------|
| 3006A831-TOP | Plana      |  | 4,44     |
| 3006A832-TOP | Media Caña |  | 4,44     |
| 3006A833-TOP | Redonda    |  | 4,22     |



mm  
200





10



**Juego de Limas, 3 pzs.**

Refer: 3006A230-TOP

Precio € 12,23









**Juego de Formones, 4 pzs.**

| Refer:       | Medidas   | Precio € |
|--------------|---|----------|
| 3009A310-TOP | 6 x 125 x 250<br>12 x 125 x 250<br>18 x 125 x 250<br>24 x 125 x 250 | 19,68    |







125 mm

**Lijas Circulares con Velcro, 5 pzs**

| Refer:     | Grano |  | Precio € Paquete |
|------------|-------|---|------------------|
| 3183432-YT | 60    | 5   | 1,53             |
| 3183433-YT | 80    | 5   | 1,53             |
| 3183434-YT | 100   | 5   | 1,53             |
| 3183435-YT | 120   | 5   | 1,53             |

Materiales: Madera - Pintura - Laca - Masilla - Metal









125 mm

**Lijas Circulares con Velcro y Orificios, 5 pzs**

| Refer:     | Grano |  | Precio € Paquete |
|------------|-------|---|------------------|
| 3183451-YT | 40    | 5   | 1,39             |
| 3183452-YT | 60    | 5   | 1,39             |
| 3183453-YT | 80    | 5   | 1,39             |
| 3183454-YT | 100   | 5   | 1,39             |
| 3183455-YT | 120   | 5   | 1,39             |
| 3183456-YT | 150   | 5   | 1,39             |
| 3183457-YT | 180   | 5   | 1,39             |
| 3183458-YT | 220   | 5   | 1,39             |

Materiales: Madera - Pintura - Laca - Masilla - Metal









230 x 280 mm

**Lija Pliego Tela Abrasiva, 10 pzs**

| Refer:       | Grano |  | Precio € Paquete |
|--------------|-------|---|------------------|
| 3008A422-TOP | 40    | 10  | 5,20             |
| 3008A424-TOP | 60    | 10  | 5,20             |
| 3008A426-TOP | 80    | 10  | 5,20             |
| 3008A428-TOP | 100   | 10  | 5,20             |
| 3008A430-TOP | 120   | 10  | 5,20             |

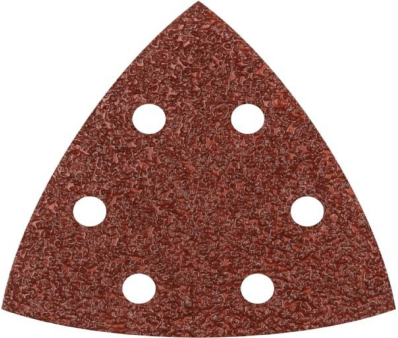
Materiales: Madera - Pintura - Laca - Masilla - Metal









96 mm

**Lija Delta Velcro Abrasiva**

| Refer:   | Grano |  | Precio € |
|----------|-------|---|----------|
| 3040-KL  | 40    | 50  | 32,53    |
| 3060-KL  | 60    | 50  | 29,74    |
| 3080-KL  | 80    | 50  | 24,74    |
| 30100-KL | 100   | 50  | 24,74    |
| 30120-KL | 120   | 50  | 24,74    |
| 30150-KL | 150   | 50  | 24,74    |
| 30180-KL | 180   | 50  | 24,74    |
| 30240-KL | 240   | 50  | 24,74    |

Materiales: Madera - Pintura - Laca - Masilla - Metal



98 x 148 mm

**Lija Mouse Velcro Abrasiva**

| Refer:   | Grano |  | Precio € |
|----------|-------|---|----------|
| 5040-KL  | 40    | 50  | 33,98    |
| 5060-KL  | 60    | 50  | 27,26    |
| 5080-KL  | 80    | 50  | 23,48    |
| 50100-KL | 100   | 50  | 23,48    |
| 50120-KL | 120   | 50  | 23,48    |

Materiales: Madera - Pintura - Laca - Masilla







150 mm

**Lija Circular Velcro Abrasiva**

| Refer:   | Grano |  | Precio € |
|----------|-------|---|----------|
| 4060-KL  | 60    | 50  | 52,24    |
| 4080-KL  | 80    | 50  | 47,88    |
| 40100-KL | 100   | 50  | 44,10    |
| 40120-KL | 120   | 50  | 44,10    |
| 40150-KL | 150   | 50  | 44,10    |
| 40180-KL | 180   | 50  | 44,10    |
| 40220-KL | 220   | 50  | 44,10    |

Materiales: Madera - Pintura - Laca - Masilla - Metal





230 x 280 mm

**Lija Pliego Papel Abrasiva**

| Refer:   | Grano |  | Precio € |
|----------|-------|---|----------|
| 2060-KL  | 60    | 50  | 32,57    |
| 2080-KL  | 80    | 50  | 30,95    |
| 20100-KL | 100   | 50  | 27,82    |
| 20120-KL | 120   | 50  | 27,82    |
| 20180-KL | 180   | 50  | 27,82    |
| 20240-KL | 240   | 50  | 28,15    |
| 20320-KL | 320   | 50  | 28,15    |

Materiales: Madera - Pintura - Laca - Masilla - Metal - Cuero - Plástico



### Coronas Diamantadas M-14 para Porcelánico

| Refer:   | Ø     | Precio € |
|----------|-------|----------|
| 9006-TOM | 6 mm  | 11,98    |
| 9008-TOM | 8 mm  | 12,15    |
| 9010-TOM | 10 mm | 12,50    |
| 9012-TOM | 12 mm | 12,95    |
| 9020-TOM | 20 mm | 15,95    |
| 9025-TOM | 25 mm | 17,70    |
| 9030-TOM | 30 mm | 21,15    |
| 9035-TOM | 35 mm | 24,70    |
| 9040-TOM | 40 mm | 28,15    |
| 9050-TOM | 50 mm | 35,15    |
| 9060-TOM | 60 mm | 42,15    |
| 9068-TOM | 68 mm | 47,70    |



M14



seco



dimante



amoladora



porcelánico - gres - marmol



uso



### Adaptador Hexagonal a rosca M14

Refer: 4150-TOM



**Precio €**  
5,51

Permite trabajar con útiles M14 en taladros manuales





**Juego Accesorios Sds Plus, 3 pzs**

|               |                         |                 |
|---------------|-------------------------|-----------------|
| <b>Refer:</b> |                         | <b>Precio €</b> |
| 101106-TOM    | Cinzel - Pala - Puntero | 13,82           |
|               | x 250 mm                |                 |





**Juego Accesorios Sds Max, 3 pzs**

|               |                         |                 |
|---------------|-------------------------|-----------------|
| <b>Refer:</b> |                         | <b>Precio €</b> |
| 101107-TOM    | Cinzel - Pala - Puntero | 29,61           |
|               | x 400 mm                |                 |



### Coronas Construcción M-22 TCT para Hormigón

| Refer:    | Ø      | Precio € |
|-----------|--------|----------|
| 9240-TOM  | 40 mm  | 13,41    |
| 9245-TOM  | 45 mm  | 14,98    |
| 9250-TOM  | 50 mm  | 16,06    |
| 9255-TOM  | 55 mm  | 17,66    |
| 9260-TOM  | 60 mm  | 18,72    |
| 9265-TOM  | 65 mm  | 19,79    |
| 9270-TOM  | 70 mm  | 20,87    |
| 9275-TOM  | 75 mm  | 23,55    |
| 9280-TOM  | 80 mm  | 24,62    |
| 9290-TOM  | 90 mm  | 32,13    |
| 92100-TOM | 100 mm | 38,94    |



### Husillos Sds Plus para Coronas M-22

| Refer:    | ↔      | Precio € |
|-----------|--------|----------|
| 93110-TOM | 110 mm | 9,92     |
| 93220-TOM | 220 mm | 11,65    |
| 93350-TOM | 350 mm | 13,59    |









### Broca Guía centradora para Coronas M-22





| Refer:      | Ø          | Precio € |
|-------------|------------|----------|
| 9308110-TOM | 8 x 110 mm | 1,92     |





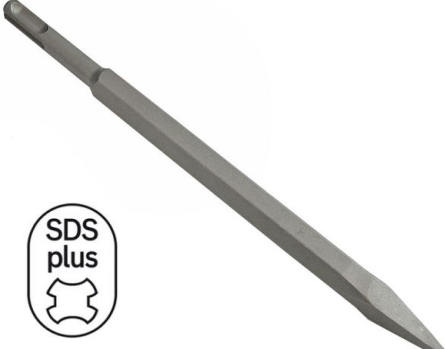
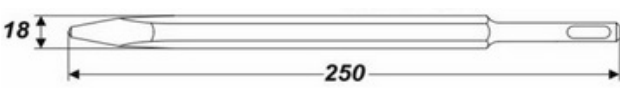

**Puntero Sds Plus 18 mm construcción**

|                            |             |                         |
|----------------------------|-------------|-------------------------|
| <b>Refer:</b><br>94250-TOM | ↔<br>250 mm | <b>Precio €</b><br>6,38 |
|----------------------------|-------------|-------------------------|



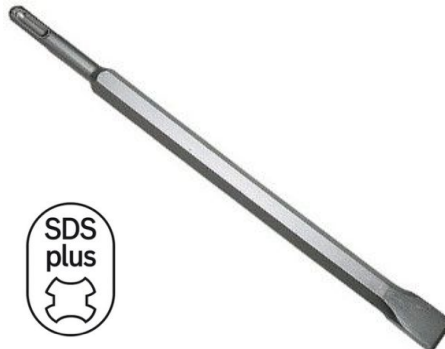

**Cinzel Sds Plus Plano 22 mm construcción**

|                              |             |                         |
|------------------------------|-------------|-------------------------|
| <b>Refer:</b><br>9422250-TOM | ↔<br>250 mm | <b>Precio €</b><br>7,26 |
|------------------------------|-------------|-------------------------|



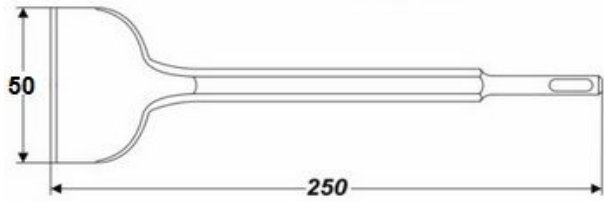

**Pala Sds Plus Ancha 50 mm construcción**

|                              |             |                         |
|------------------------------|-------------|-------------------------|
| <b>Refer:</b><br>9450250-TOM | ↔<br>250 mm | <b>Precio €</b><br>9,35 |
|------------------------------|-------------|-------------------------|

**Cinzel Sds Plus Hueco Acanalado construcción**

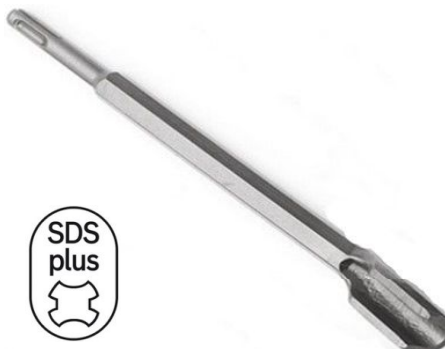
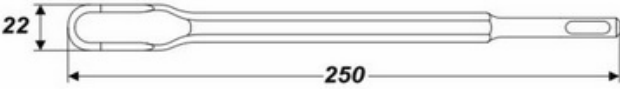
|                              |             |                         |
|------------------------------|-------------|-------------------------|
| <b>Refer:</b><br>9414250-TOM | ↔<br>250 mm | <b>Precio €</b><br>7,01 |
|------------------------------|-------------|-------------------------|

**Puntero Sds Max 18 mm construcción**

Refer: 9518400-TOM ↔ 400 mm Precio € 9,55

**Cinzel Sds Max Plano 25 mm construcción**

Refer: 9525400-TOM ↔ 400 mm Precio € 10,28

**Pala Sds Max Ancha 50 mm construcción**

Refer: 9550400-TOM ↔ 400 mm Precio € 12,85





# VIKING

## Coronas HSS Bi-Metal Cobalto 8% para Madera, Metal y Plástico

| Refer:  | Medidas            | Precio € | Refer:   | Medidas           | Precio € |
|---------|--------------------|----------|----------|-------------------|----------|
| 9114-MO | 14.3 mm # 9/16"    | 6,87     | 9157-MO  | 57.2 mm # 2 1/4"  | 11,94    |
| 9116-MO | 15.9 mm            | 6,84     | 9159-MO  | 58.7 mm # 2 5/16" | 11,94    |
| 9117-MO | 17.5 mm # 11/16"   | 6,84     | 9160-MO  | 60.3 mm # 2 3/8"  | 13,17    |
| 9119-MO | 19 mm # 3/4"       | 6,84     | 9162-MO  | 62 mm             | 13,17    |
| 9120-MO | 20 mm              | 6,84     | 9164-MO  | 63.5 mm # 2 1/2"  | 13,17    |
| 9121-MO | 20.7 mm # 13/16"   | 6,84     | 9165-MO  | 65.1 mm # 2 9/16" | 13,17    |
| 9122-MO | 22.2 mm # 7/8"     | 6,84     | 9167-MO  | 66.7 mm # 2 5/8"  | 13,17    |
| 9124-MO | 23.8 mm # 15/16"   | 7,20     | 9168-MO  | 68 mm             | 13,17    |
| 9125-MO | 25.4 mm # 1"       | 7,20     | 9170-MO  | 69.9 mm # 2 3/4"  | 13,32    |
| 9127-MO | 27 mm # 1 11/16"   | 7,20     | 9173-MO  | 73 mm # 2 7/8"    | 13,32    |
| 9129-MO | 28.6 mm # 1 1/8"   | 7,20     | 9175-MO  | 75 mm             | 13,32    |
| 9130-MO | 30 mm              | 7,20     | 9176-MO  | 76.2 mm # 3"      | 13,32    |
| 9132-MO | 31.8 mm # 1 1/4"   | 7,29     | 9179-MO  | 79.4 mm # 3 1/8"  | 13,32    |
| 9133-MO | 33 mm # 1 5/16"    | 7,29     | 9183-MO  | 82.6 mm # 3 1/4"  | 13,81    |
| 9135-MO | 34.9 mm # 1 3/8"   | 7,71     | 9186-MO  | 85.7 mm # 3 3/8"  | 13,81    |
| 9137-MO | 36.5 mm # 1 7/16"  | 7,71     | 9189-MO  | 88.9 mm # 3 1/2"  | 13,81    |
| 9138-MO | 38.1 mm # 1 1/2"   | 7,71     | 9192-MO  | 92.1 mm # 3 5/8"  | 15,90    |
| 9140-MO | 39.7 mm # 1 9/16"  | 7,71     | 9195-MO  | 95.3 mm # 3 3/4"  | 15,90    |
| 9141-MO | 41.3 mm # 1 5/8"   | 7,71     | 9198-MO  | 98.4 mm # 3 7/8"  | 18,50    |
| 9143-MO | 42.9 mm # 1 11/16" | 7,71     | 91100-MO | 100 mm            | 19,17    |
| 9144-MO | 44.5 mm # 1 3/4"   | 9,60     | 91102-MO | 102 mm # 4"       | 19,82    |
| 9145-MO | 45 mm              | 9,60     | 91105-MO | 104.8 mm # 4 1/8" | 19,82    |
| 9146-MO | 46 mm # 1 13/16"   | 9,60     | 91111-MO | 111.1 mm # 4 3/8" | 30,99    |
| 9148-MO | 47.6 mm # 1 7/8"   | 9,60     | 91114-MO | 114.3 mm # 4 1/2" | 32,28    |
| 9150-MO | 50 mm              | 9,60     | 91121-MO | 120.7 mm # 4 3/4" | 34,34    |
| 9151-MO | 50.8 mm # 2"       | 9,60     | 91127-MO | 127 mm # 5"       | 36,92    |
| 9152-MO | 52.4 mm # 2 1/16"  | 11,94    | 91133-MO | 133 mm            | 37,45    |
| 9154-MO | 54 mm # 2 1/8"     | 11,94    | 91140-MO | 139.7 mm # 5 1/2" | 39,16    |
| 9155-MO | 55 mm              | 11,94    | 91146-MO | 146 mm # 5 3/4"   | 41,01    |
|         |                    |          | 91152-MO | 152.4 mm # 6"     | 43,45    |



## Juego de Coronas BI-METAL Cobalto 8%

Refer: **91S125-TOM** Precio € **57,59**

Especial para FONTANEROS y ELECTRICISTAS

Coronas: 16 - 20 - 25 - 32 - 40 - 50 mm

Husillos: 9134C - 9135PS

En maletín de PVC rígido



**Husillos para coronas BI-METAL**



**Refer:** 9134C-MO **Precio €** 9,13

Husillo para coronas de 14 a 30 mm  
Rosca 1/2 UNF  
Cogida hexagonal de 9,5 mm



**Refer:** 9135PS-MO **Precio €** 12,20

Husillo para coronas de 32 a 250 mm  
Rosca 5/8 UNF  
Cogida hexagonal de 9,5 mm



**Refer:** 9147SDS-MO **Precio €** 17,30



Husillo para coronas de 32 a 250 mm  
con sistema de roscado y pivotes  
Cogida SDS PLUS



**Brocas Centradoras para Husillos**



| Refer:         | Medida     | Precio € |
|----------------|------------|----------|
| 99MPD/4S-TOM   | 6,35 x 80  | 2,72     |
| 99MPD/4N01-TOM | 6,35 x 100 | 3,25     |



**Broca Fregaderos**

| Refer:      | Ø     | Precio € |
|-------------|-------|----------|
| 1270/32-UPO | 32 mm | 21,70    |
| 1270/35-UPO | 35 mm | 23,95    |

Especial para Acero Inoxidable  
Acero: 2 mm de espesor  
Aluminio: 5 mm de espesor



**Fresa para Madera**

| Refer:     | Ø     | Precio € |
|------------|-------|----------|
| 445/25-TOM | 25 mm | 7,58     |
| 445/35-TOM | 35 mm | 9,80     |

Especial bisagras de cazoleta  
en muebles de cocina



**Brocas de Sierra Campana múltiples**

| <u>Refer:</u>    | <u>Hojas</u>                                      | <u>Precio €</u> |
|------------------|---|-----------------|
| <b>670-GUO</b>   | Corta 1" - 2,5 mm                                 | 3,82            |
| <b>671-GUO</b>   | Larga 2" - 5 mm<br>26, 32, 38, 45, 50, 56 y 63 mm | 5,03            |
| <b>28725-VOR</b> | Grande 40 mm de hoja<br>60, 67, 74, 81 y 95 mm    | 9,21            |

Calidad Bricolage



**Juego de Accesorios Mini Taladro, 100 pzs**

| <u>Refer:</u>       | <u>Contiene:</u> | <u>Precio €</u> |
|---------------------|------------------|-----------------|
| <b>3050G029-TOP</b> |                  | 22,25           |

Cepillos, lijas, piedras de amolar, pulidores, pasta de pulir, discos de corte



**Juego de Coronas de Tungsteno, 8 pzs**

| <u>Refer:</u>  | <u>Medidas:</u> | <u>Precio €</u> |
|----------------|-----------------|-----------------|
| <b>502-TOM</b> |                 | 45,62           |

Ø 33 - 53 - 67 - 73 - 83 mm  
Azulejos - Cerámica - Ladrillo



**Discos Abrasivos Mini, 10 pzs**

**Refer:**  
55H071

Ø 20 mm

**Precio €**  
5,74



**Discos de Corte Mini, 10 pzs**

**Refer:**  
55H072

Ø 32 mm

**Precio €**  
6,72



**Ruedas Mini Lijadoras, 11 pzs**

**Refer:**  
55H069

Ø 6,3 mm x Gr 60-120

**Precio €**  
4,48



**Soportes Mini para Discos, 2 pzs**

**Refer:**  
55H074

Eje 3,2 mm

**Precio €**  
3,16



**Fresas Mini Abrasivas, 2 pzs**

**Refer:**  
55H062

Ø 3,2 mm Multimaterial

**Precio €**  
5,10



**Brocas Mini Precisión, 7 pzs**

**Refer:**  
55H075

Ø 0,8 - 1,2 - 1,6 - 2 - 2,4 - 3,2

**Precio €**  
6,02



**Fresas Mini Abrasivas, 3 pzs**

|               |                 |                 |
|---------------|-----------------|-----------------|
| <b>Refer:</b> |                 | <b>Precio €</b> |
| 55H056        | Ø 6 mm x 10 mm  | 4,48            |
| 55H057        | Ø 10 mm x 20 mm | 4,82            |



**Fresas Mini Abrasivas, 3 pzs**

|               |                 |                 |
|---------------|-----------------|-----------------|
| <b>Refer:</b> |                 | <b>Precio €</b> |
| 55H051        | Ø 5 mm x 10 mm  | 4,48            |
| 55H052        | Ø 10 mm x 12 mm | 4,82            |



**Cepillos Mini Pulidores, 15 pzs**

|               |                       |                 |
|---------------|-----------------------|-----------------|
| <b>Refer:</b> |                       | <b>Precio €</b> |
| 55H078        | Ø 5 - 15 - 22 - 25 mm | 10,56           |



**Ruedas Mini Abrasivas, 24 pzs**

|               |                              |                 |
|---------------|------------------------------|-----------------|
| <b>Refer:</b> |                              | <b>Precio €</b> |
| 55H081        | Ø 6,3 x 12,7 mm / 16 x 32 mm | 10,56           |



**Cepillos Mini Abrasivos, 3 pzs**

|               |                  |                 |
|---------------|------------------|-----------------|
| <b>Refer:</b> |                  | <b>Precio €</b> |
| 55H066        | Ø 5 - 15 - 20 mm | 4,48            |

## Hojas de Calar para: Bosch - AEG - Metabo - Casals - Hitachi

|                    |  |                                      |                                    |
|--------------------|--|--------------------------------------|------------------------------------|
| Refer:<br>3106-MPS |  | Classic - Line<br>Made in Germany CV | Precio €<br><u>Blister</u><br>4,24 |
|                    |  |                                      |                                    |

|                    |  |                                    |                                    |
|--------------------|--|------------------------------------|------------------------------------|
| Refer:<br>3104-MPS |  | Profi - Line<br>Made in Germany CV | Precio €<br><u>Blister</u><br>5,14 |
|                    |  |                                    |                                    |

|                    |  |                                    |                                    |
|--------------------|--|------------------------------------|------------------------------------|
| Refer:<br>3101-MPS |  | Profi - Line<br>Made in Germany CV | Precio €<br><u>Blister</u><br>6,37 |
|                    |  |                                    |                                    |

|                    |  |                                    |                                    |
|--------------------|--|------------------------------------|------------------------------------|
| Refer:<br>3102-MPS |  | Profi - Line<br>Made in Germany CV | Precio €<br><u>Blister</u><br>6,58 |
|                    |  |                                    |                                    |

|                      |  |                                    |                                    |
|----------------------|--|------------------------------------|------------------------------------|
| Refer:<br>3104XL-MPS |  | Profi - Line<br>Made in Germany CV | Precio €<br><u>Blister</u><br>9,15 |
|                      |  |                                    |                                    |

|                    |  |                                      |                                    |
|--------------------|--|--------------------------------------|------------------------------------|
| Refer:<br>3109-MPS |  | Classic - Line<br>Made in Germany CV | Precio €<br><u>Blister</u><br>5,95 |
|                    |  |                                      |                                    |



|  |                |  |
|--|----------------|--|
| <p><b>Refer:</b><br/>3111-MPS</p>      |                | <p><b>Precio €</b><br/><b>Blister</b><br/>6,21</p> |
| <p>Fino 1,2 mm x 50 mm x 21 t.p.i.</p> | <p>(T118A)</p> | <p><b>Metal</b></p>                                |

|                                      |                |   |
|--------------------------------------|----------------|---|
| <p><b>Refer:</b><br/>3114-MPS</p>    |                | <p><b>Precio €</b><br/><b>Blister</b><br/>10,19</p> |
| <p>Fino 1.2 x 110 mm x 21 t.p.i.</p> | <p>(T318A)</p> | <p><b>Metal Larga</b></p>                           |

|                                      |                 |   |
|--------------------------------------|-----------------|---|
| <p><b>Refer:</b><br/>3159F-MPS</p>   |                 | <p><b>Precio €</b><br/><b>Blister</b><br/>19,38</p> |
| <p>Fino 1.4 x 180 mm x 18 t.p.i.</p> | <p>(T718BF)</p> | <p><b>Metal Extra Larga</b></p>                     |

|  |  |   |
|--|--|---|
| <p><b>Refer:</b><br/>3150FKR-MPS</p>         |  | <p><b>Precio €</b><br/><b>Blister</b><br/>17,29</p> |
| <p>Doble 1.8-2.5 x 110 mm x 10-14 t.p.i.</p> |  | <p><b>Metal - Madera</b></p>                        |

|                                     |  |   |
|-------------------------------------|--|---|
| <p><b>Refer:</b><br/>3121-MPS</p>   |  | <p>Blister con 1 und</p> <p><b>Precio €</b><br/><b>Blister</b><br/>4,63</p> |
| <p>Carbuos de Tungsteno x 50 mm</p> |  | <p><b>Fibra de Vidrio - Cerámica</b></p>                                    |

Hojas de Calar para: Black & Decker - Hitachi - Milwaukee

|                                    |  |  |         |        |                 |
|------------------------------------|--|--|---------|--------|-----------------|
| Refer:<br>3406-MPS                 |  | 3406 MPS «wood» Classic - Line<br>Made in Germany CV | (U111C) | Madera | Precio €        |
|                                    |  |  |         |        | Blister<br>5,09 |
| Semi-gueso 3 mm x 75 mm x 8 t.p.i. |  |  |         |        |                 |

|                                |  |  |         |        |                 |
|--------------------------------|--|--|---------|--------|-----------------|
| Refer:<br>3404-MPS             |  | 3404 MPS «wood» Profi - Line<br>Made in Germany CV | (U144D) | Madera | Precio €        |
|                                |  |  |         |        | Blister<br>5,72 |
| Grueso 4 mm x 75 mm x 6 t.p.i. |  |  |         |        |                 |

|                                       |  |  |         |            |                 |
|---------------------------------------|--|--|---------|------------|-----------------|
| Refer:<br>3401-MPS                    |  | 3401 MPS «wood» Profi - Line<br>Made in Germany CV | (U101B) | Aglomerado | Precio €        |
|                                       |  |  |         |            | Blister<br>7,75 |
| Semi-gueso 2,5 mm x 75 mm x 10 t.p.i. |  |  |         |            |                 |

|                                 |  |  |         |        |                 |
|---------------------------------|--|--|---------|--------|-----------------|
| Refer:<br>3406L-MPS             |  | 3406-L MPS «wood» Classic - Line<br>Made in Germany CV | (U101B) | Madera | Precio €        |
|                                 |  |  |         |        | Blister<br>6,63 |
| Semi-fino 4 x 110 mm x 6 t.p.i. |  |  |         |        |                 |

|                                   |  |  |          |                                     |                 |
|-----------------------------------|--|--|----------|-------------------------------------|-----------------|
| Refer:<br>3402-MPS                |  | 3402 MPS «wood» Profi - Line<br>Made in Germany CV | (U101BR) | Madera<br>Con Diente hacia adelante | Precio €        |
|                                   |  |  |          |                                     | Blister<br>7,70 |
| Semi-fino 2.5 x 75 mm x 10 t.p.i. |  |  |          |                                     |                 |

|                            |  |  |          |                   |                 |
|----------------------------|--|--|----------|-------------------|-----------------|
| Refer:<br>3409-MPS         |  | 3409 MPS «wood» Classic - Line<br>Made in Germany CV | (U101BR) | Madera - Plástico | Precio €        |
|                            |  |  |          |                   | Blister<br>5,95 |
| Fino 2 x 60 mm x 12 t.p.i. |  |  |          |                   |                 |

Refer:  
3411-MPS



Fino 1,2 mm x 50 mm x 21 t.p.i.

(U118A)

Metal

Precio €  
Blister  
7,34

Refer:  
991118/B-VI



Fino 2.5 x 50 mm

Metal

Precio €  
Blister  
7,76

Refer:  
3414-MPS



Fino 1.2 x 110 mm x 21 t.p.i.

(U318A)

Metal Larga

Precio €  
Blister  
10,19

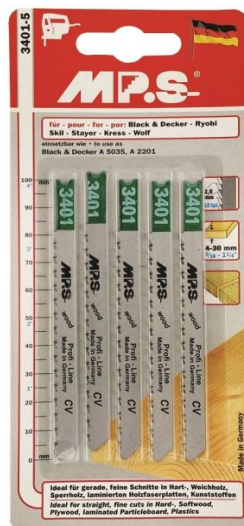

Hojas de Sierra de Sable "VIKING" para: Bosch - Metabo - Makita - Hitachi - De Walt

**Refer:**  
4011-MPS

Semi-grueso 4,2 mm x 150 mm x 6 t.p.i.

**Madera**

Precio €  
**Blíster 2 uds**  
6,68

**Refer:**  
4022-MPS

Grueso 8,5 mm x 230 mm x 3 t.p.i.

**Madera**

Precio €  
**Blíster 2 uds**  
7,23

**Refer:**  
4020-MPS

Grueso 8,5 mm x 300 mm x 3 t.p.i.

**Madera**

Precio €  
**Blíster 2 uds**  
8,48

**Refer:**  
4430-MPS

Fino 2,5 mm x 150 mm x 10 t.p.i.

**Metal**

Precio €  
**Blíster 2 uds**  
7,68

**Refer:**  
4434-MPS

Fino 2,5 mm x 230 mm x 10 t.p.i.

**Metal**

Precio €  
**Blíster 2 uds**  
10,65

**Refer:**  
4442VP-MPS

Fino 1,8-2,5 mm x 300 mm x 10-14 t.p.i.

**Metal**

Precio €  
**Blíster 2 uds**  
16,54

Hojas de Sierra de Sable "VIKING" para: Bosch - Metabo - Makita - Hitachi - De Walt

**Refer:**  
4037-MPS



Made in Germany  
CV - Chrom Vanadium

wood

MPS Sägen GmbH  
Coronal-Königs-Str. 13  
D-54332 Wassenach

**Precio €**  
**Blister 2 uds**  
6,78

Semi-grueso 4,2 mm x 230 mm x 6 t.p.i.

Pvc - Madera

**Refer:**  
4052-MPS



Made in Germany  
CV - Chrom Vanadium

wood-green

MPS Sägen GmbH  
Coronal-Königs-Str. 13  
D-54332 Wassenach

**Precio €**  
**Blister 2 uds**  
9,07

Grueso Irregular 5-6,5 mm x 240 mm x 4-5 t.p.i.

Madera Verde

**Refer:**  
4177-MPS



MPS Sägen GmbH  
Coronal-Königs-Str. 13  
D-54332 Wassenach

abrasive

**Precio €**  
**Blister 1 und**  
16,27

Semi-grueso 8,5 mm x 230 mm x 3 t.p.i.

Fibro cemento



Hojas de Sierra de Mano 300 mm

**Refer:** 971210/SUP-VI

**VIKING**

**Descripción**  
Hoja Bi-metal 300 mm  
20/24 Dientes por pulgada  
Dentado Alternativo

100 HOJAS

**Precio €**  
1,72

**Refer:** 921210-VI

**VIKING**

**Descripción**  
Hoja Acero al Carbono 300 mm  
24 Dientes por pulgada

100 HOJAS

**Precio €**  
0,81

**Refer:** 3010A332

**TOMISA**

**Descripción**  
Hoja Acero al Carbono 300 mm  
24 Dientes por pulgada

50 HOJAS

**Precio €**  
0,96

**Refer:** 3010A337

**TOMISA**

**Descripción**  
Hoja Acero al Carbono 300 mm.  
24 - 8 Dientes por pulgada  
Doble corte **Madera y Metal**

50 HOJAS

**Precio €**  
1,03



**Cuchilla Multiherramienta 20 mm**

Refer: 3056H051 Precio € 6,36





**Cuchilla Multiherramienta 34 mm**

Refer: 3056H050 Precio € 6,52







**Cuchilla Multiherramienta 87 mm**

Refer: 3056H002 Precio € 9,10



**Cuchilla Multiherramienta 87 mm**

Refer: 3056H001 Precio € 6,52





**Gafas de Policarbonato Incolora**

**Refer:**  
EVAMED



10

**Precio €**  
2,24

Frente de una pieza incluyendo los oculares.  
Protecciones laterales incorporadas en las patillas.  
Espesor del ocular: 2.00 mm.  
Normas: EN166 - EN170



**Gafas de Policarbonato Ahumada**

**Refer:**  
EVASUN



10

**Precio €**  
2,53

Frente de una pieza incluyendo los oculares.  
Protecciones laterales incorporadas en las patillas.  
Espesor del ocular: 2.00 mm.  
Normas: EN166 - EN172



**Gafas de Policarbonato Incolora**

**Refer:**  
EVALAB



10

**Precio €**  
1,80

Patillas perforadas para uso de cordón de sujeción.  
Montura y patillas de policarbonato incoloro.  
Modelo sin ningun pieza metálica.  
Espesor del ocular: 2.00 mm.  
Normas: EN166 - EN170



**Gafas Antirayadura Regulable**

**Refer:**  
EVASPORTN



10

**Precio €**  
2,70

Patillas perforadas para uso de cordón de sujeción  
Ocular monobloque policarbonato con proteccion lateral.  
Montura de poliamida, color negro.  
Espesor del ocular: 2.00 mm.  
Normas: EN166 - EN170



**Gafas Antirayadura y Antivaho**

**Refer:**  
EVALIT



10

**Precio €**  
5,12

Ocular: espesor 2.00 mm. Policarbonato incoloro.  
Montura y patillas: policarbonato.  
Puente nasal: policarbonato.  
Tornillos: acero inoxidable.  
Normas: EN166 - EN170



**Gafas Policarbonato Patillas Tpr**

**Refer:**  
EVARED



10

**Precio €**  
5,17

Ocular: espesor 2.00 mm de una sola pieza en policarbonato incoloro.  
Puenta nasal: policarbonato integrado a la montura.  
Tornillos: acero inoxidable.  
Normas: EN166 - EN170





**Gafas con Montura Integral**

**Refer:**  
EVAMAS



**Precio €**  
2,95

Con ventilación directa. Banda elástica ajustable.  
Montura PVC suave. Ocular de policarbonato incoloro.  
Espesor del ocular: 1.50 mm. Normas EN166



**Gafas Patillas Tpr Ahumadas**

**Refer:**  
EVAREDA



**Precio €**  
5,55

Ocular: espesor 2.00 mm de una sola pieza en policarbonato incoloro. Normas EN166 y EN172  
Punta nasal: policarbonato integrado a la montura.



**Careta Protección Visor Plástico**

**Refer:**  
EVA805



**Precio €**  
12,53

Banda desudadora.  
Espesor del visor: 1.00 mm.  
Dimensiones del visor: 305 x 190 mm. Normas EN166



**Careta Protección Rejilla Metálica**

**Refer:**  
EVA825



**Precio €**  
14,36

Malla metálica en acero inoxidable.  
Banda desudadora.  
Dimensiones del visor: 305 x 195 mm. Normas EN1731

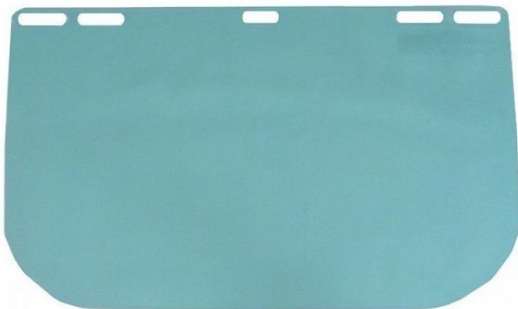

**Visor de recambio para careta**

**Refer:**  
ACC805LARG



**Precio €**  
5,69

Fabricado en policarbonato incoloro.  
Fácil ajuste sobre el arnés.  
Dimensiones: 395 x 200 mm. Normas EN1731



**Rejilla de recambio para careta**

**Refer:**  
880F83-UPO



**Precio €**  
6,86

Malla metálica en acero inoxidable.  
Fácil ajuste sobre el arnés.  
Dimensiones: 305 x 195 mm. Normas EN1731



**Mascarillas Autofiltrantes KN95**

**Refer:**  
KN95



**Precio €**  
0,91

*Diseño ergonómico.  
Clip nasal y elástico de ajuste.  
Transpirable e impermeable.  
Standard GB2626-2006 KN95*



**Mascarillas Antipolvo con Válvula**

**Refer:**  
1047-VO



FFP2

**Precio €**  
**Caja**  
17,35

*Clip nasal ajustable.  
Elásticos ajustables.  
Normativa EN149:2001+A1:2009*



**Tallas**  
L - XL - XXL

**Buzo Desechable Riesgo Menor**

**Refer:**  
PP-1B



CAT I

**Precio €**  
3,96

*Polipropileno 50 g/m2  
Cintura, puños y tobillos elásticos  
Cubierta con cremallera  
Trabajos de mantenimiento y bricolage*



**Tallas**  
L - XL - XXL

**Buzo Desechable Riesgo Químico**

**Refer:**  
CS500E



CAT III  
5B + 6B

**Precio €**  
7,10

*Polipropileno 65 g/m2  
Cintura, puños y tobillos elásticos  
Cubierta con cremallera  
Trabajos químicos nocivos*



**Protector de Oídos Bricolage**

**Refer:**

CASBRUI

Peso: 145 grs

Norma EN352-1

SNR 29dB (H:33 dB M:27dB L:17 dB).

**Precio €**

5,69



**Protector de Oídos Profesional**

**Refer:**

HG106J

Peso: 168 grs

Norma EN352-1

SNR: 27,6dB (H:30,4 dB M:24,9 dB L:17,7 dB).

**Precio €**

8,41



**Protector de Oídos ELECTRONICO "CE"**

**Refer:**

805/E-UPO

**Precio €**

39,12

Protege de ruidos a partir de 85 Db.

Funciona con 2 pilas AA (no incluidas).

Permite escuchar con normalidad hasta 85 Db.

Banda del cabezal ajustable.



**Tapón Auditivo Pu sin cordón**

**Refer:**

HGB030



50

**Precio €**

**Caja**

9,77

SNR 34dB (H: 33 dB M: 31 dB L: 28 dB).

Diámetro 6-12 mm. Norma EN352-2



**Tapón Auditivo Pu con cordón**

**Refer:**

HGB030C



50

**Precio €**

**Caja**

19,49

SNR 34dB (H: 33 dB M: 31 dB L: 28 dB).

Diámetro 6-12 mm. Norma EN352-2



EN 388:2016  
3131X

CE

**Guante Poliester Revestido en PU gris**

**Refer:** 2803/...-TOM **Precio €** 0,95

- \* Agricultura
- \* Almacenaje
- \* Construcción

6 - 7 - 8 - 9 - 10 12 240



EN 388:2016  
3131X

CE

**Guante Poliester Revestido en PU negro**

**Refer:** 2903/...-TOM **Precio €** 0,95

- \* Agricultura
- \* Almacenaje
- \* Construcción

7 - 8 - 9 - 10 12 240



**Guante de Nitrilo Verde Reforzado**

**Refer:** 81600/...-MAT **Precio €** 2,46

- \* Agroquímicos
- \* Bricolage

EN 388: 2016 EN ISO 374-1:2016 / Tipo A EN ISO 374-5:2016

4101X JKLOPT VIRUS

CE  
CAT - III

Flocado Espesor: 0,38 mm Largo: 315 mm

8 - 9 - 10 12 144



EN 388:2016  
3141X

CE

**Guante Algodón y Látex Rugoso**

**Refer:** 1201/...-TOM **Precio €** 1,73

- \* Agricultura
- \* Jardinería
- \* Construcción

8 - 9 - 10 12 120



CE

EN 388:2016



3121X

**Guante Poliester Revestido en Nitrilo**

**Refer:**

2002/...-TOM

**Precio €**

0,95

- \* Agricultura
- \* Almacenaje
- \* Construcción



6 - 7 - 8 - 9 - 10



12



120



EN 388



4244X

EN 407



41324X

CE

**Guante de Soldador Crupón Vacuno**

**Refer:**

81500/09-TOM

**Precio €**

5,35

- \* Soldadura
- \* Calderería
- \* Hornos

↔  
350 mm



9

TIPO A



12



60



CE

EN 388:2016



2122X

**Guante Piel y Algodón con Velcro**

**Refer:**

81400/...-TOM

sin colgador de cartón

**Precio €**

3,90

81401/...-TOM

con colgador de cartón

4,05

- \* Agricultura
- \* Almacenaje
- \* Construcción



7 - 8 - 9 - 10



12



120



CE

EN 388:2016



4144X

**Guante Limonero Piel y Serraje**

**Refer:**

81250/...-TOM

sin colgador de cartón

**Precio €**

4,90

81251/...-TOM

con colgador de cartón

5,05

- \* Agricultura
- \* Soldadura



7 - 8 - 9 - 10



12



60



EN 388:2016  
3121X

**Guante Piel Flor Vacuno Blanco**

| Refer:         |                        | Precio € |
|----------------|------------------------|----------|
| 81200/...-TOM  | sin colgador de cartón | 3,70     |
| 81201/...C-TOM | con colgador de cartón | 3,90     |

- \* Construcción
- \* Almacenaje
- \* Automoción



7 - 8 - 9 - 10 - 11



12



120



EN 388:2016  
3121X

**Guante Piel Flor Eco Blanco**

| Refer:         |                        | Precio € |
|----------------|------------------------|----------|
| 81300/...-TOM  | sin colgador de cartón | 3,14     |
| 81301/...C-TOM | con colgador de cartón | 3,25     |

- \* Construcción
- \* Almacenaje
- \* Automoción



7 - 8 - 9 - 10 - 11



12



120



**Guante de Nitrilo Reforzado Extra Largo**

| Refer:      | Precio € |
|-------------|----------|
| 81690/09-IS | 7,56     |

- \* Procesos Químicos
- \* Refinerías
- \* Laboratorio



CAT - III



Flocado    Espesor: 0,58 mm    Largo: 450 mm



9



12



120



EN 388:2016  
4244X



**Guante Serraje Crupón Vacuno y Lona**

| Refer:        | Precio € |
|---------------|----------|
| 81208/...-TOM | 2,95     |

- \* Construcción
- \* Almacenaje
- \* Ferralla



9 - 10



12



120



CE

**Guante Desechable Nitrilo Azul 3,5 Gr**

**Refer:** 81800/...-MAT **Precio €** 5,36

- \* Puño con reborde
- \* Sin polvo
- \* Ambidiestros

ISO 374-1:2016/A1:2018 / Tipo B

ISO 374-5:2016



J K T



VIRUS



S - M - L - XL



100



1000



CE

**Guante Desechable Nitrilo Negro 5,0 Gr**

**Refer:** 81850/...-MAT **Precio €** 7,18

- \* Puño con reborde
- \* Sin polvo
- \* Ambidiestros

ISO 374-1:2016/A1:2018 / Tipo B

ISO 374-5:2016



J K T



VIRUS



S - M - L - XL



100



1000



CE

**Guante Diamantado Nitrilo Naranja 8,5 Gr**

**Refer:** 81900/...-MAT **Precio €** 8,09

- \* Puño con reborde
- \* Sin polvo
- \* Ambidiestros

ISO 374-1:2016/A1:2018 / Tipo B

ISO 374-5:2016



J K T



VIRUS



M - L - XL



50



500



**Guante de Latex Bicolor 100 % Reforzado**

**Refer:** 81120/...-MAT **Precio €** 1,52

- \* Albañilería
- \* Bricolage
- \* Agricultura

CE

CAT - III



Flocado Espesor: 0,45 mm Largo: 300 mm



8 - 9 - 10



12



120



**Aceitera de Precisión Gota a Gota**

**Refer:**  
3987-PR

**Precio €**  
15,54

Cuerpo de Aluminio



**Aceitera Metálica con latiguillo flexible**

**Refer:**  
326130-PR

Depósito 300 ml

**Precio €**  
4,50



**Densímetro de Cristal para líquidos**

**Refer:**  
3740-PR

**Precio €**  
5,51

Para medir los niveles de ácido de las baterías



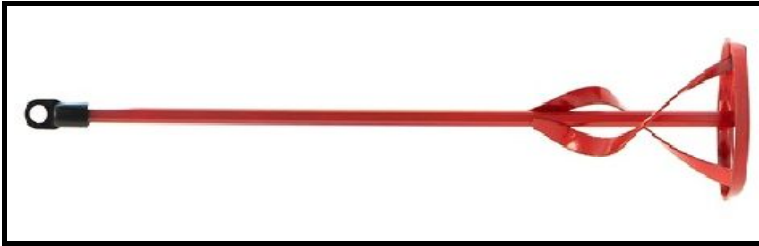

**Batidores de Pintura Hexagonales**

| Refer:     | Ø   | ↔   | Precio € |
|------------|-----|-----|----------|
| 1115/1-TOM | 60  | 400 | 3,10     |
| 1115/2-TOM | 85  | 400 | 3,49     |
| 1115/3-TOM | 100 | 600 | 5,15     |

**Mezcladores de Mortero Rosca M-14**

| Refer:     | Ø   | ↔   | Precio € |
|------------|-----|-----|----------|
| 1116/1-TOM | 100 | 600 | 11,25    |
| 1116/2-TOM | 120 | 600 | 11,95    |
| 1116/3-TOM | 140 | 600 | 13,25    |

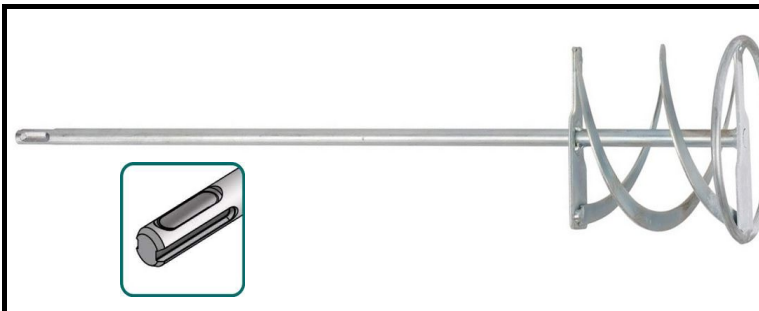
Ideales para remover mortero, yeso y cemento cola.  
Fabricados en acero cincado.  
Enganche mediante rosca M-14.

**Mezcladores de Mortero Sds Plus**

| Refer:     | Ø   | ↔   | Precio € |
|------------|-----|-----|----------|
| 1117/1-TOM | 100 | 600 | 8,50     |
| 1117/2-TOM | 120 | 600 | 9,25     |

Ideales para remover mortero, yeso y cemento cola.  
Fabricados en acero cincado.  
Enganche mediante sistema Sds Plus.

**Desatascador de Ventosa**

| Refer:   | Ø           | Precio € |
|----------|-------------|----------|
| 55505-YT | 65 - 155 mm | 13,93    |

**Desatascadores de Muelle**

| Refer:    | ↔              | Precio € |
|-----------|----------------|----------|
| 10050-TOM | 1,5 mts x 6 mm | 3,58     |
| 10051-TOM | 3 mts x 6 mm   | 6,85     |
| 10052-TOM | 4,5 mts x 6 mm | 9,79     |
| 10055-TOM | 6 mts x 8 mm   | 18,50    |
| 10056-TOM | 8 mts x 8 mm   | 20,36    |



**Grapadora Manual Cromada**

**Refer:** **3041E905** **Precio €** 10,20  
 Admite grapas de 4 a 14mm  
 Regulador de presión



Compatible con: ESCO 530 - NOVUS 53



**Grapadora Manual de Plástico**

**Refer:** **3171000-YT** **Precio €** 5,91  
 Admite grapas de 4 a 8 mm



Compatible con: ESCO 530 - NOVUS 53



**Grapadora de Golpe**

**Refer:** **334-UPO** **Precio €** 22,10

Admite grapas de 6 a 14 mm



**Grapas para grapadora manual, cajas 1000 uds.**

| <b>Refer:</b> | <b>←→</b>          | <b>Precio €</b> |
|---------------|--------------------|-----------------|
| 338/6-PR      | 6 mm x 11,3 x 0,7  | 0,98            |
| 338/8-PR      | 8 mm x 11,3 x 0,7  | 1,03            |
| 338/10-PR     | 10 mm x 11,3 x 0,7 | 1,06            |
| 338/12-PR     | 12 mm x 11,3 x 0,7 | 1,58            |
| 338/14-PR     | 14 mm x 11,3 x 0,7 | 1,46            |

Compatibles con: ESCO 530 - NOVUS 53



**Marcadores permanentes 3 pzs.**

**Refer:** **699-PR** **Precio €** 3,47  
 Colores: azul, rojo y negro

Resistente al agua

Blíster

24



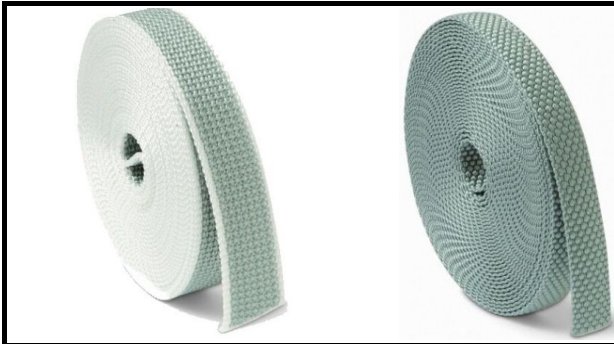

**Cintas de Persianas en rollos y bobinas**

| Refer:        | ↔              |       | Precio € |
|---------------|----------------|-------|----------|
| 67MINI/6-CL   | 14 mm x 6 mts  | Mini  | 1,78     |
| 67107GP/6-CL  | 20 mm x 6 mts  | Eco   | 1,85     |
| 67150GC/6-CL  | 20 mm x 6 mts  | Extra | 2,51     |
| 67MINI/50-CL  | 14 mm x 50 mts | Mini  | 12,04    |
| 67107GP/50-CL | 20 mm x 50 mts | Eco   | 12,61    |
| 67150GC/50-CL | 20 mm x 50 mts | Extra | 17,87    |



**Trinquetes de Nylon con Hebilla, 2 pzs.**

| Refer:       | ↔               |  | Precio € |
|--------------|-----------------|--|----------|
| 3097X183-TOP | 2,5 mts x 25 mm |  | 7,53     |
| 3097X184-TOP | 5 mts x 25 mm   |  | 10,37    |

📦  
12



**Trinquetes de Nylon con carraca**

| Refer:    |   | Precio € |
|-----------|---|----------|
| 3755/1-PR | SIN ganchos<br>Cinta de 5 mts x 25 mm ancho   | 6,94     |
| 3755/2-PR | CON 2 ganchos<br>Cinta de 5 mts x 25 mm ancho | 7,20     |

📦  
12



**Cinturón serraje Porta-Herramientas**

| Refer:       | Precio € |
|--------------|----------|
| 3079R401-TOP | 13,58    |

Múltiples bolsillos

En Serraje de cerdo



**Rascavidrios de Plástico con 2 Hojas**

**Refer:**  
3018B550-TOP



**Precio €**  
0,92

Hoja No recambiable tipo trapecio

**Rascavidrios de Plástico Reforzado**

**Refer:**  
815-PR

**Precio €**  
1,34

Hoja recambiable tipo trapecio



**Juego de Fresas, 6 pzs.**

**Refer:**  
444-PR Aluminio - Madera - Plástico



**Precio €**  
23,52



**Juego Piedras de esmeril, 5 pzs.**

**Refer:**  
3060H005-TOP



**Precio €**  
3,33



**Juego de Piedras, 5 pzs.**

**Refer:**  
60H007 Madera - Plástico



**Precio €**  
8,29



**Juego de Minilimas, 6 pzs.**

**Refer:**  
62-PR 150



**Precio €**  
6,19



**Tijera de Recolección 190 mm**

|                            |                         |
|----------------------------|-------------------------|
| <b>Refer:</b><br>318816-YT | <b>Precio €</b><br>8,62 |
|----------------------------|-------------------------|



**Tijera de Vendimia 180 mm**

|                            |                         |
|----------------------------|-------------------------|
| <b>Refer:</b><br>318815-YT | <b>Precio €</b><br>8,62 |
|----------------------------|-------------------------|



**Tijera de Podar con Muelle 190 mm**

|                               |                         |
|-------------------------------|-------------------------|
| <b>Refer:</b><br>3015G200-TOP | <b>Precio €</b><br>7,79 |
|-------------------------------|-------------------------|

Ø Máximo de corte: 10 mm

**Tijera de Podar con Muelle 215 mm**

|                             |                         |
|-----------------------------|-------------------------|
| <b>Refer:</b><br>3199203-YT | <b>Precio €</b><br>8,93 |
|-----------------------------|-------------------------|

Ø Máximo de corte: 15 mm



**Pistola de Silicona Bricolage**

**Refer:**  
330/2-TOM

**Precio €**  
2,94



24

Para cartuchos de silicona de poca densidad

**Pistola de Silicona Skeleto**

**Refer:**  
331-TOM

**Precio €**  
5,05



24

Incluye limpiador de boquilla

**Pistola de Silicona Dentada**

**Refer:**  
330-TOM

**Precio €**  
4,90



24

Incluye limpiador de boquilla y cuchilla

**Pistola de Silicona Profesional**

**Refer:**  
333-TOM

**Precio €**  
9,48



24

Incluye limpiador de boquilla



**Pistola de Silicona Reforzada**

**Refer:**  
333/2-TOM

**Precio €**  
15,65

  
12

Incluye limpiador de boquilla

Especial para masillas y resinas



**Pistola de Triple Émbolo**

**Refer:**  
335/2-TOM

**Precio €**  
16,84

  
12

Para cartuchos químicos de 410 ml



**Pistola Aluminio Cerrada**

**Refer:**  
332/310-TOM  
332/600-TOM

**Precio €**  
10,32  
12,65

  
12

Para usos con cartuchos y bolsas de mortero  
Incluye boquilla y tapón retenedor para líquidos



**Boma Sopladora Agujeros**

**Refer:**  
CP10-GB

**Precio €**  
10,95

Cuerpo de plástico, y cánula giratoria.

Ideal para extraer polvo sobrante tras el taladrado.

| <b>Espátulas mango de madera</b> |     |    |                 |
|----------------------------------|-----|----|-----------------|
| <u>Refer:</u>                    | ↔   |    | <u>Precio €</u> |
| 68/40-PR                         | 40  | 12 | 1,13            |
| 68/50-PR                         | 50  | 12 | 1,22            |
| 68/60-PR                         | 60  | 12 | 1,33            |
| 68/80-PR                         | 80  | 12 | 1,56            |
| 68/100-PR                        | 100 | 12 | 1,76            |

| <b>Espátulas Inoxidables mango Bi-material</b> |     |    |                 |
|--|-----|----|-----------------|
| <u>Refer:</u>                                  | ↔   |    | <u>Precio €</u> |
| 3018B604-TOP                                   | 40  | 12 | 2,47            |
| 3018B606-TOP                                   | 63  | 12 | 3,00            |
| 3018B607-TOP                                   | 75  | 12 | 3,09            |
| 3018B610-TOP                                   | 100 | 12 | 3,56            |
| 3018B612-TOP                                   | 125 | 12 | 4,28            |

|   |   |
|---|---|
|   |   |
| <b>Espátulas de carroceros Metálicas, 4 pzs</b>   | <b>Espátulas de carroceros Plásticas, 4 pzs</b> |
| <u>Refer:</u><br>390-TOM                          | <u>Refer:</u><br>390A-PF                        |
| De hojas muy flexibles                            | De hojas muy flexibles                          |
| <u>Precio €</u><br>2,48                           | <u>Precio €</u><br>1,45                         |
|   |   |
| <b>Espátulas de carroceros Inoxidables, 4 pzs</b> | <b>Espátula de Plástico Dentada</b>             |
| <u>Refer:</u><br>391-TOM                          | <u>Refer:</u><br>390/B-PR                       |
| De hojas muy flexibles                            | ↔<br>90 x 130 mm                                |
| <u>Precio €</u><br>4,28                           | <u>Precio €</u><br>0,59                         |





**Embudo de Plástico Flexible**

|                         |                         |
|-------------------------|-------------------------|
| <b>Refer:</b><br>620151 | <b>Precio €</b><br>2,29 |
|-------------------------|-------------------------|

Diámetro Boca: 140 mm

Longitud Flexo: 380 mm



**Llave para Amoladora Universal**

|                           |   |                         |
|---------------------------|---|-------------------------|
| <b>Refer:</b><br>3066H320 |  | <b>Precio €</b><br>6,41 |
|---------------------------|---|-------------------------|

Para Radiales de 115 mm y 230 mm



**Llave para Amoladora Regulable**

|                           |   |                         |
|---------------------------|---|-------------------------|
| <b>Refer:</b><br>4490-TOM |  | <b>Precio €</b><br>8,20 |
|---------------------------|---|-------------------------|

Para Radiales de 115 mm y 230 mm



**Llave para Lavabo Articulada**

|                          |   |                          |
|--------------------------|---|--------------------------|
| <b>Refer:</b><br>191-TOM | <br>250 mm | <b>Precio €</b><br>13,95 |
|--------------------------|---|--------------------------|

Rango de apertura: 15 - 32 mm



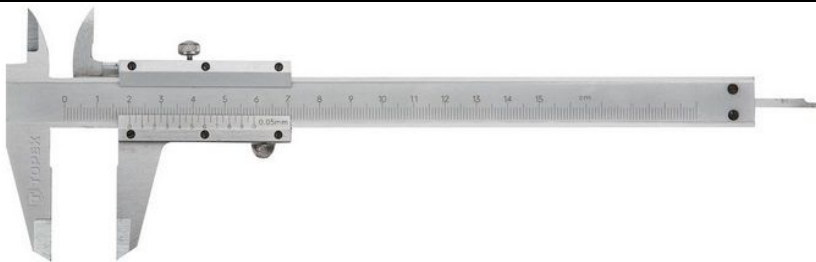

**Calibre Digital**

|                          |  |            |                        |                          |
|--------------------------|--|------------|------------------------|--------------------------|
| <b>Refer:</b><br>1346-PR | <br>150 | Inoxidable | En Estuche de Plástico | <b>Precio €</b><br>27,10 |
|--------------------------|--|------------|------------------------|--------------------------|





**Calibres Metálicos**

|                          |  |            |                        |                          |
|--------------------------|--|------------|------------------------|--------------------------|
| <b>Refer:</b><br>1345-PR | <br>150 | Inoxidable | En Funda de Cuero      | <b>Precio €</b><br>20,89 |
| <b>580804</b>            | <br>150 | Acero      | En Estuche de Plástico | <b>Precio €</b><br>16,06 |





**Calibre de Plástico**

|                         |  |   |                         |
|-------------------------|--|---|-------------------------|
| <b>Refer:</b><br>134-PR | <br>150 |  | <b>Precio €</b><br>2,10 |
|-------------------------|--|---|-------------------------|





**Transportador de Angulos con Regla**

|                         |  |            |   |                         |
|-------------------------|--|------------|---|-------------------------|
| <b>Refer:</b><br>580718 | <br>150 | Inoxidable |  | <b>Precio €</b><br>7,09 |
|-------------------------|--|------------|---|-------------------------|





**Niveles de Aluminio, Profesionales**

| Refer:       | ↔    |  | Precio € |
|--------------|------|---|----------|
| 3029C602-TOP | 600  | 3   | 15,01    |
| 3029C603-TOP | 800  | 3   | 17,58    |
| 3029C604-TOP | 1000 | 3   | 21,45    |





**Niveles de Aluminio, Bricolage**

| Refer:       | ↔   |  | Precio € |
|--------------|-----|--|----------|
| 3029C501-TOP | 400 | 2  | 6,83     |
| 3029C502-TOP | 600 | 2  | 8,44     |
| 3029C503-TOP | 800 | 2  | 12,28    |

**Nivel Torpedo Magnético**

| Refer:   | ↔   |  | Precio € |
|----------|-----|---|----------|
| 3029C894 | 230 | 3   | 2,81     |



**Nivel Angular Regulable**

Refer: 3030C321-TOP

500

2

Precio € 31,20



**Nivel Plegable Magnético**

Refer: 3029C897-TOP

Precio € 4,89

3



**Flexómetros con Freno y Correa**

| Refer:       |             |    | Precio € |
|--------------|-------------|----|----------|
| 3027C303-TOP | 3 M x 16 mm | 10 | 3,51     |
| 3027C305-TOP | 5 M x 19 mm | 10 | 5,55     |
| 3027C308-TOP | 8 M x 25 mm | 6  | 9,40     |



**Flexómetros con Freno, Correa e Imán**

| Refer:       |             |    | Precio € |
|--------------|-------------|----|----------|
| 3027C343-TOP | 3 M x 19 mm | 12 | 5,97     |
| 3027C345-TOP | 5 M x 25 mm | 12 | 8,34     |



**Cinta Métrica Metálica con Carcasa**

Refer: 3028C412-TOP

20 M x 12,5 mm

Precio € 12,32



**Cinta Métrica de Nylon Abierta**

Refer: 3028C550-TOP

50 M x 13 mm

Precio € 17,51

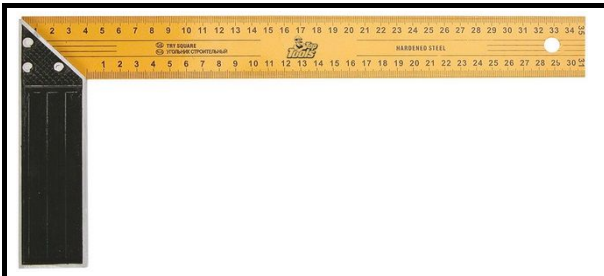

**Escuadra para Carpintero Bricolage**

| Refer:       | ↔   | 📦 | Precio € |
|--------------|-----|---|----------|
| 3030C335-TOP | 350 | 6 | 2,85     |

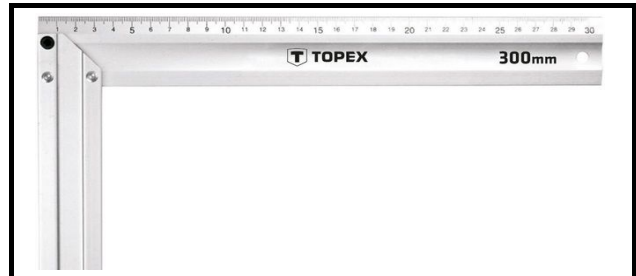

**Escuadra para Carpintero Profesional**

| Refer:       | ↔   | 📦 | Precio € |
|--------------|-----|---|----------|
| 580713       | 300 | 6 | 7,22     |
| 3030C364-TOP | 350 | 6 | 8,17     |
| 580714       | 400 | 6 | 8,66     |



**Martillo Ebanista con Mango de Madera**

| Refer:     | g   | 📏  | Precio € |
|------------|-----|----|----------|
| 57/100-TOM | 100 | 16 | 3,28     |
| 57/200-TOM | 200 | 18 | 3,37     |
| 57/250-TOM | 250 | 20 | 4,27     |
| 57/300-TOM | 300 | 22 | 4,76     |
| 57/400-TOM | 400 | 25 | 5,42     |
| 57/500-TOM | 500 | 28 | 6,44     |
|            |     | 📦  | 6        |



**Llave de Sifón Forrada**

| Refer: | ↔   | 📦 | Precio € |
|--------|-----|---|----------|
| 190-PR | 230 | 5 | 7,80     |

Bocas Plásticas.

Diámetro máximo apertura: 80 mm

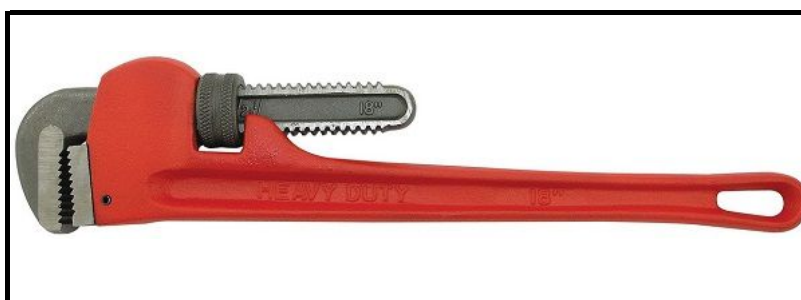

**Llaves Stillson Profesionales**

| Refer:    | ↔    |    | Precio € |
|-----------|------|----|----------|
| 10300-TOM | 300  | 12 | 14,65    |
| 10350-TOM | 350  | 14 | 17,95    |
| 10450-TOM | 450  | 18 | 25,45    |
| 10600-TOM | 600  | 24 | 37,90    |
| 600816    | 900  | 36 | 57,36    |
| 600817    | 1200 | 48 | 93,81    |

📦  
6



**Llaves Stillson de Aluminio**

| Refer:    | ↔    |    | Precio € |
|-----------|------|----|----------|
| 20250-TOM | 250  | 10 | 18,53    |
| 20300-TOM | 300  | 12 | 23,18    |
| 20350-TOM | 350  | 14 | 29,71    |
| 20450-TOM | 450  | 18 | 44,78    |
| 20600-TOM | 600  | 24 | 69,65    |
| 20900-TOM | 900  | 36 | 139,50   |
| 20120-TOM | 1200 | 48 | 232,54   |

📦  
6



**Rectificador de Asientos de Grifo**

| Refer:    | 📦 | 📦 | Precio € |
|-----------|---|---|----------|
| 50016-TOM | 6 |   | 14,53    |

Incluye 6 fresas: 10, 12, 13, 14, 15 y 16 mm

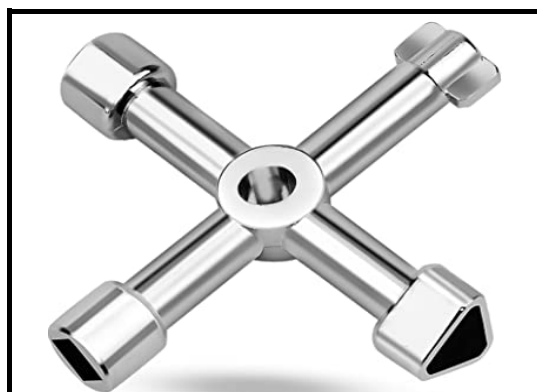

**Llave para Contadores de 4 Usos**

| Refer:      | 📦  | 📦 | Precio € |
|-------------|----|---|----------|
| 4424667-TOM | 20 |   | 4,56     |



**Tenaza Pico Loro Botón**

| Refer:      | ↔   | 📦  | Precio € |
|-------------|-----|----|----------|
| 273/240-TOM | 250 | 10 | 19,52    |
| 273/300-TOM | 300 | 6  | 24,22    |

Cromo Vanadio. DIN ISO 8976



**Tenaza Pico Loro Forrada**

| Refer:       | ↔   | 📦  | Precio € |
|--------------|-----|----|----------|
| 272CV/175-PR | 175 | 10 | 7,06     |
| 272CV/240-PR | 240 | 10 | 8,31     |
| 272CV/300-PR | 300 | 10 | 13,51    |
| 272CV/400-PR | 400 | 5  | 43,35    |

Cromo Vanadio. DIN ISO 8976 C



**Llave de Cadena Profesional**

| Refer:      | ↔   | 📦 | Precio € |
|-------------|-----|---|----------|
| 1170300-TOM | 410 | 6 | 31,70    |
| 1170560-TOM | 560 | 6 | 34,11    |

Disponible en 2 largos de cadena.



**Llave de Cadena Gran Carga**

| Refer:      | ↔   | 📦 | Precio € |
|-------------|-----|---|----------|
| 1170900-TOM | 900 | 1 | 86,30    |

Longitud de cadena: 747 mm

Bocas forjadas dentadas y eje en acero



**Llave de Cinta Profesional**

| Refer:    | ↔              | 📦 | Precio € |
|-----------|----------------|---|----------|
| 258-TOM   | 1000           | 5 | 33,88    |
| 258/B-TOM | Cinta Repuesto |   | 6,50     |

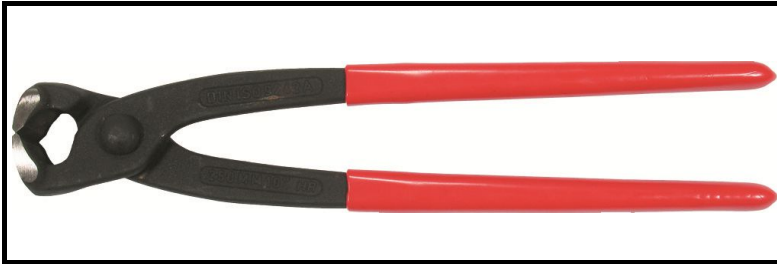

**Tenaza Rusa Forrada**

| Refer:     | ↔   |    | Precio € |
|------------|-----|----|----------|
| 278/220-PR | 220 | 10 | 4,94     |
| 278/250-PR | 250 | 10 | 5,38     |
| 278/280-PR | 280 | 10 | 6,37     |

Cromo Vanadio DIN ISO 9242 A



**Corta-Cables de acero Trenzado**

| Refer:  | ↔   |  | Precio € |
|---------|-----|--|----------|
| 1250-PR | 190 |  | 19,74    |

Mangos Plastificados.

Corte Máximo: 5 mm.

Con muelle de apertura y palanca de cierre.



**Alicate de Corte Frontal Profesional**

| Refer:         | ↔   | Precio € |
|----------------|-----|----------|
| 831236/160-PAD | 160 | 29,23    |

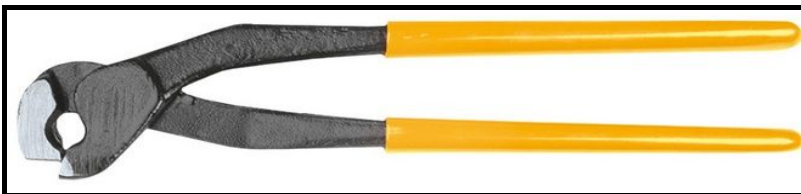

**Alicate para Cortar Azulejos**

| Refer:       | ↔   | Precio € |
|--------------|-----|----------|
| 3016B440-TOP | 200 | 7,32     |



**Tijera Cortachapa con Muelle**

| Refer:  | ↔   | Precio € |
|---------|-----|----------|
| 387-TOM | 250 | 9,63     |

Mango Ergonómico







**Alicate Universal Profesional**

**Refer:** 1185/180-TOM 180 12 **Precio €** 15,99

Acero al Cr-Mo

Acabado Satinado



**Alicate Corte Lateral Profesional**

**Refer:** 1170/160-TOM 160 12 **Precio €** 13,98

Acero al Cr-Mo

Acabado Satinado



**Alicate Universal Aislado Profesional**

**Refer:** 1185/180VDE-TOM 180 12 **Precio €** 17,41

Acero al Cr-Mo

Acabado Satinado



**Alicate Corte Aislado Profesional**

**Refer:** 1170/160VDE-TOM 160 12 **Precio €** 15,66

Acero al Cr-Mo

Acabado Satinado



**Pelacables Manual Aislado Profesional**

**Refer:** 1172/160VDE-TOM 160 12 **Precio €** 16,55

Acero al Cr-Mo

Acabado Satinado



**Alicates para Bujías "ELORA"**



| Refer:        | Descripción | ↔   | Precio € |
|---------------|-------------|-----|----------|
| 464/200AI-ELO | Pico Curvo  | 200 | 23,19    |



| Refer:        | Descripción | ↔   | Precio € |
|---------------|-------------|-----|----------|
| 465/230AI-ELO | Pico Recto  | 230 | 35,35    |
| 465/300AI-ELO | Pico Recto  | 300 | 40,25    |

**Alicate para Válvulas "ELORA"**



| Refer:  | ↔   | Precio € |
|---------|-----|----------|
| 268-ELO | 275 | 42,56    |

Alicate válido para VW y AUDI

**Alicate para Frenos de Mano "ELORA"**



| Refer: | ↔   | Precio € |
|--------|-----|----------|
| 296-PR | 230 | 31,61    |

Alicate para montar y desmontar los cables de los frenos de mano 2.5 mm.

**Alicates para Anillos de Segmentos**



| Refer:     | Precio € |
|------------|----------|
| 235/60-ELO | 32,92    |

Para anillos entre 60 y 160 mm.  
Bocas en Acero C-45.



| Refer:     | Precio € |
|------------|----------|
| 235/30-ELO | 22,88    |

Para anillos entre 30 y 60 mm.  
Bocas en Acero C-45.  
Con tornillo de fijación para evitar un alargamiento excesivo.



**Mordaza Grip Universal**

| Refer:      | ↔   | Precio € |
|-------------|-----|----------|
| 287/180-TOM | 180 | 7,73     |
| 287/250-TOM | 250 | 8,79     |



 Calidad Bricolaje



**Mordaza Grip Universal Forrada**

| Refer:       | ↔   | Precio € |
|--------------|-----|----------|
| 3032D856-TOP | 250 | 14,97    |



 Cr V  
 Calidad Semi-Profesional



**Mordaza de Mesa Profesional**

| Refer:      | ↔   | Precio € |
|-------------|-----|----------|
| 523/300-ELO | 285 | 34,50    |

Para sujeción de piezas sobre una mesa.  
 Atornillable a un lugar fijo.  
 Niquelada



**Mordaza Grip Boca de Cobre**

| Refer:      | ↔   | Precio € |
|-------------|-----|----------|
| 522/235-ELO | 235 | 32,58    |

Bocas planas (fija y oscilante). Apertura 0 - 40 mm  
 Superior en cobre e inferior en CrV.  
 Propia para trabajos de soldadura.



**Mordaza Grip Bocas Oscilantes**

| Refer:     | ↔   | Precio € |
|------------|-----|----------|
| 506/50-ELO | 255 | 24,37    |

Bocas paralelas oscilantes de 80 mm de ancho.  
 Niquelada.





**Mordaza Grip Basculante**

|               |     |                 |
|---------------|-----|-----------------|
| <b>Refer:</b> | ↔   | <b>Precio €</b> |
| 521/290-ELO   | 290 | 39,18           |

Capacidad de 0-70 mm



**Mordaza para Chapistas**

|               |     |                 |
|---------------|-----|-----------------|
| <b>Refer:</b> | ↔   | <b>Precio €</b> |
| 514/210-ELO   | 210 | 32,62           |



**Mordaza para Chapistas**

|               |     |                 |
|---------------|-----|-----------------|
| <b>Refer:</b> | ↔   | <b>Precio €</b> |
| 517/230-ELO   | 230 | 33,69           |



**Mordaza para Chapistas**

|               |     |                 |
|---------------|-----|-----------------|
| <b>Refer:</b> | ↔   | <b>Precio €</b> |
| 513/195-ELO   | 195 | 48,00           |



**Cuter de Plástico**
**Refer:**  
212-PR

**Precio €**  
0,84

**Cuter de Plástico con Guía Metálica**
**Refer:**  
570301

**Precio €**  
1,31

**Cuter de Plástico**
**Refer:**  
211-PR

**Precio €**  
0,95

**Cuter de Plástico y Metal**
**Refer:**  
570306

**Precio €**  
1,14

**Cuter de Plástico y Goma**
**Refer:**  
570312

**Precio €**  
3,06

Incluye 3 cuchillas



**Hojas de Recambio para Cuter**



**Refer:**  
570341



9 mm

**Precio €**  
1,20

Hoja tronzeable

Blíster: 10 pzs.



24

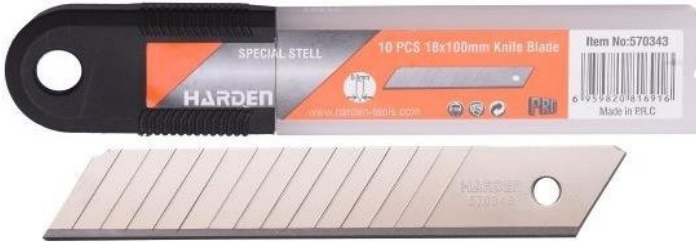

**Refer:**  
570343



18 mm

**Precio €**  
1,47

Hoja tronzeable

Blíster: 10 pzs.



40



**Refer:**  
570349



25 mm

**Precio €**  
4,24

Hoja tronzeable

Blíster: 10 pzs.



12

**Hojas de Recambio para Rascador**



**Refer:**  
620219



100 mm

**Precio €**  
1,80

Blíster: 10 pzs.



12

**Hojas de Recambio tipo trapecio**



**Refer:**  
570345

2 orificios

**Precio €**  
1,43

Blíster: 10 pzs.



**Refer:**  
3017B2H5-TOP

2 orificios y ganchos

**Precio €**  
2,98

Blíster: 5 pzs.

**Cortatubos y Cuchillas de Recambio**
**Refer:**
**3020022-TOM**

Modelo Mini

**3030032-TOM**

Modelo Grande con rascador

**3034D052-TOP**

Recambios 6 uds de 18 x 3 mm

 **mm**

3 a 22

3 a 32

**Precio €**

6,75

11,79

9,07

**Cizallas para corte de PVC**
**Refer:**
**74/42-PR**
 **mm**

42

**Precio €**

25,98

**74/42B-TOM**

Hoja Recambio 42 mm

3,98

**Cortavarillas Profesional**
**Refer:**
**30350-TOM**

14" - 350 mm

**Precio €**

18,13

**30450-TOM**

18" - 450 mm

24,25

**30600-TOM**

24" - 600 mm

33,25

**30750-TOM**

30" - 750 mm

41,62

**30900-TOM**

36" - 900 mm

57,55

**Acero Cr V**
**Dureza HRC40**

**Recambio Cuchilla Cortavarillas**
**Refer:**
**30350B-TOM**

14" - 350 mm

**Precio €**

9,90

**30450B-TOM**

18" - 450 mm

11,83

**30600B-TOM**

24" - 600 mm

19,95

**30750B-TOM**

30" - 750 mm

22,72

**30900B-TOM**

36" - 900 mm

28,07

**Acero Cr V**
**Dureza HRC40**





**DIN 7254**      ↔            **CR V**

| Refer:       |     |    |             |   | Precio € |
|--------------|-----|----|-------------|---|----------|
| 4000/200-PAD | 200 | 10 | Mango Plano |  | 10,50    |
| 4000/250-PAD | 250 | 10 | Mango Plano | <b>MADE IN GERMANY</b>  | 11,85    |
| 4000/300-PAD | 300 | 10 | Mango Plano |   | 14,46    |
| 4000/400-PAD | 400 | 10 | Mango Plano |   | 18,75    |

**Cinceles de Albañil**





**365/200-PAD**      ↔            **CR V**

| Refer:      |              |    |                | Precio €   |      |
|-------------|--------------|----|----------------|--|------|
| 365/200-PAD | 200 x 8 x 10 | 10 | Mango Cuadrado |  | 8,49 |
| 365/250-PAD | 250 x 8 x 10 | 10 | Mango Cuadrado | <b>MADE IN GERMANY</b>   | 8,94 |

**Cinceles de Electricista**





**3003A136-TOP**      ↔            **300**

**Cinzel con Protector**

Refer: **3003A136-TOP**      Precio € **5,47**





**1244/1922-WH**

**Llave Carraca Andamio**

Refer: **1244/1922-WH**      Precio € **33,38**



19x22





**Mango de Plástico con Hoja Doble**

Refer: 3010A212-TOP

Hoja con doble diente: Madera - Metal

Precio € 2,74



**Cuñas para Azulejos Albañil**

Refer: 04700

 100  23 mm

Precio € 0,85



**Juego Cuchillas Precisión, 16 pzs**

Refer: 17B716

Cuchillas tipo bisturí

Precio € 6,45



**Cajetín de Corte a 22.5°, 45° y 90°**

Refer: 3010A844-TOP

 mm

295 La x 80 An x 70 Al

Precio € 7,14



**Cajetín de Corte a 22.5°, 45° y 90°**

Refer: 3010A846-TOP

 mm

320 La x 120 An x 75 Al

Precio € 10,82



  
 12

Dientes templados

|   |   |     |  |                 |
|---|---|-----|--|-----------------|
| <b>Serrucho de Punta Fina Mango curvo</b> |   | ↔   |  | <b>Precio €</b> |
| <b>Refer:</b><br>631215                   | Hoja de 1.2 mm x 150 mm en acero al carbono<br>Mango en PP y TPR bi-color.<br>Dientes alternativos. | 150 |  | 6,73            |



  
 12

Dientes templados

|  |  |     |  |                 |
|--|--|-----|--|-----------------|
| <b>Serrucho de Punta Fina Hoja Larga</b> |  | ↔   |  | <b>Precio €</b> |
| <b>Refer:</b><br>631227                  | Hoja de 1.0 mm (T) x 270 mm en acero al carbono.<br>Mango en ABS y TPR.<br>Dientes alternativos. | 270 |  | 6,68            |



  
 10

Dientes templados

|  |  |     |  |                 |
|--|--|-----|--|-----------------|
| <b>Serruchos de Carpintero con mango Bi-material</b> |  | ↔   |  | <b>Precio €</b> |
| <b>Refer:</b><br>631016                              |  | 400 |  | 9,53            |
| 631018   |  | 450 |  | 9,80            |



  
 10

Dientes templados

|  |  |     |  |                 |
|--|--|-----|--|-----------------|
| <b>Serruchos de Costilla con mango Bi-material</b> |  | ↔   |  | <b>Precio €</b> |
| <b>Refer:</b><br>3010A703-TOP                      |  | 300 |  | 9,50            |
| 3010A706-TOP                                       |  | 350 |  | 11,65           |



| Rasqueta para Juntas |     |          |
|----------------------|-----|----------|
| Refer:               | ↔   | Precio € |
| 3016B471-TOP         | 210 | 6,06     |

| Recambios para Rasqueta |       |          |
|-------------------------|-------|----------|
| Refer:                  |       | Precio € |
| 3016B471/1-TOP          | 2 uds | 2,83     |



**Arco de sierra Mango Engomado Profesional**

Refer: 27322-YT

300

6

Precio € 14,61



**Arco de sierra tubular Mango Aluminio**

Refer: 3010A225-TOP

300

6

Precio € 6,83



**Arco de sierra tubular Mango Plástico**

Refer: 610702

300

10

Precio € 4,22



**Miniarco de sierra Mango de Plástico**

|               |   |   |                 |
|---------------|---|---|-----------------|
| <b>Refer:</b> |  |  | <b>Precio €</b> |
| 686-TOM       | 150   | 25  | 1,85            |



**Miniarco de sierra Mango de Plástico**

|               |   |   |                 |
|---------------|---|---|-----------------|
| <b>Refer:</b> |  |  | <b>Precio €</b> |
| 610701        | 150   | 10  | 2,95            |

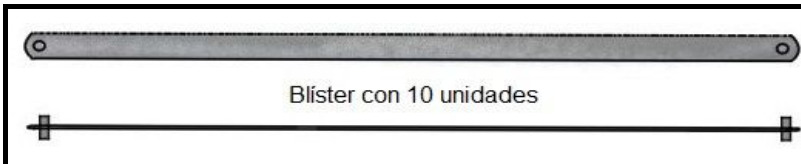

**Hojas de sierra Mini de 150 mm**

|               |   |   |                 |
|---------------|---|---|-----------------|
| <b>Refer:</b> |  |  | <b>Precio €</b> |
| 688/150-PR    | 150   | 12  | 2,15            |

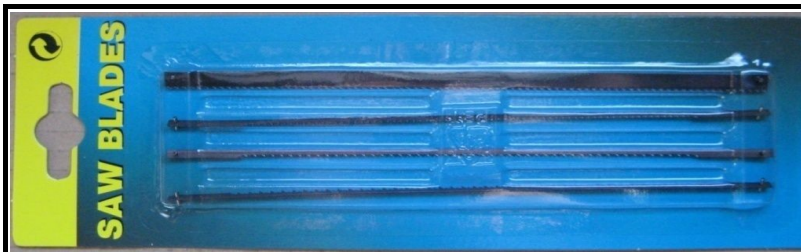

**Hojas de Recambio Marquetería**

|               |   |   |                 |
|---------------|---|---|-----------------|
| <b>Refer:</b> |  |  | <b>Precio €</b> |
| YU-4330H4-UPO | 165   | 12  | 1,90            |

Blister con 4 hojas

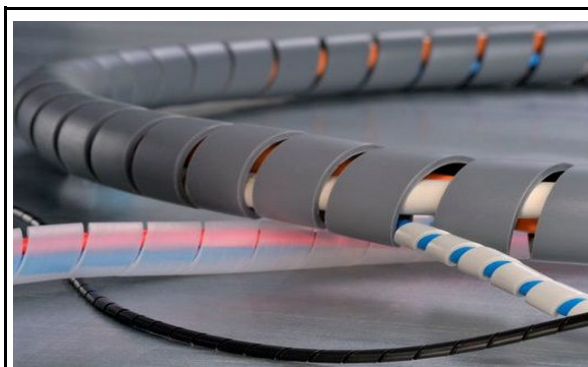
**Espiral Organizadora de Cables**

| Refer:       | Ø        | Mts. x | Color        | € Rollo |
|--------------|----------|--------|--------------|---------|
| 870912/N-TOM | 9-12 mm  | 10     | Negro        | 8,45    |
| 870912/B-TOM | 9-12 mm  | 10     | Transparente | 8,45    |
| 871519/N-TOM | 15-19 mm | 10     | Negro        | 12,10   |
| 871519/B-TOM | 15-19 mm | 10     | Transparente | 12,10   |
| 872024/N-TOM | 20-24 mm | 10     | Negro        | 15,99   |
| 872024/B-TOM | 20-24 mm | 10     | Transparente | 15,99   |

**Funda Termorretractil Negra para unir y aislar cables**

| Refer:        | Ø       | Mts. x         | € Bolsa |
|---------------|---------|----------------|---------|
| 27TRM24N-LER  | 2,4 mm  | 10 tiras x 1 m | 2,35    |
| 27TRM34N-LER  | 3,4 mm  | 10 tiras x 1 m | 2,65    |
| 27TRM49N-LER  | 4,9 mm  | 10 tiras x 1 m | 3,39    |
| 27TRM64N-LER  | 6,4 mm  | 10 tiras x 1 m | 4,03    |
| 27TRM95N-LER  | 9,4 mm  | 10 tiras x 1 m | 4,95    |
| 27TRM125N-LER | 12,5 mm | 10 tiras x 1 m | 7,25    |
| 27TRM200N-LER | 20,0 mm | 10 tiras x 1 m | 14,11   |

Ratio de Contracción: 2:1

**Estuche Funda Termorretractil 520 pzs**

 Refer:  
27TRM-TOM

 Precio €  
8,45

Ratio de Contracción: 2:1

Longitud piezas: 45 mm

5 colores: negro, rojo, verde, azul y amarillo.

Ideal para unión y aislamiento de cables eléctricos.







**Grapa con Taco para Manguera Eléctrica**

| Refer:  | Ø       |  | € Caja |
|---------|---------|---|--------|
| 500G-NL | 3-13 mm | 100   | 10,32  |



**Grapas para Cables eléctricos con punta de acero**

| Refer:      | Tipo de cable     |  | € Caja |
|-------------|-------------------|---|--------|
| 63000/04-VO | Manguera de 4 mm  | 100   | 2,62   |
| 63010/05-VO | Manguera de 5 mm  | 100   | 2,62   |
| 63020/06-VO | Manguera de 6 mm  | 100   | 2,65   |
| 63030/07-VO | Manguera de 7 mm  | 100   | 2,87   |
| 63040/08-VO | Manguera de 8 mm  | 100   | 3,16   |
| 63050/10-VO | Manguera de 10 mm | 100   | 4,55   |
| 63060/12-VO | Manguera de 12 mm | 100   | 5,35   |
| 63120/06-VO | Paralelo de 6 mm  | 100   | 2,72   |
| 63110/08-VO | Paralelo de 8 mm  | 100   | 3,43   |



**Clavija de Goma**

**Refer:** 86147-REV

**Precio €** 2,80

Según Norma DIN 49441

Según Normas VDE, OVE e IP 44

Flexible y segura



 20



**Base Aerea de Goma**

**Refer:** 86151-REV

**Precio €** 4,09

Según Norma DIN 49441

Según Normas VDE, OVE e IP 20

Flexible y segura



 20

**Clavijas con Toma-Tierra**

 En policarbonato  
 Según normas VDE, OVE y otras.

| Refer:    | Modelo                  | Color |    | Precio € |
|-----------|-------------------------|-------|----|----------|
| 86110-REV | Toma frontal con cuello | Negro | 50 | 1,20     |



| Refer:    | Modelo       | Color |    | Precio € |
|-----------|--------------|-------|----|----------|
| 86109-REV | Toma lateral | Negro | 50 | 1,26     |



| Refer:    | Modelo       | Color  |    | Precio € |
|-----------|--------------|--------|----|----------|
| 86100-REV | Toma frontal | Blanco | 50 | 1,12     |

|           |                         |        |    |      |
|-----------|-------------------------|--------|----|------|
| 86101-REV | Toma frontal con cuello | Blanco | 50 | 1,15 |
|-----------|-------------------------|--------|----|------|

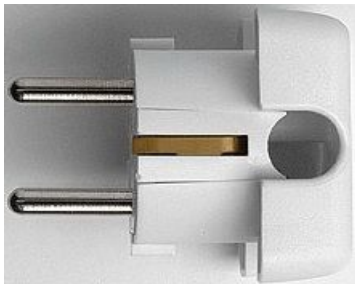

| Refer:    | Modelo       | Color  |    | Precio € |
|-----------|--------------|--------|----|----------|
| 86111-REV | Toma lateral | Blanco | 40 | 1,70     |

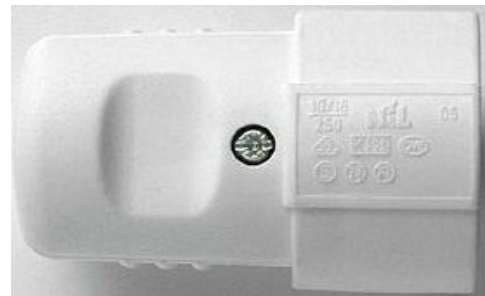
**Extra Plana**

**Base Aerea Negra con Toma-Tierra**

| Refer:    |            |    | Precio € |
|-----------|------------|----|----------|
| 86099-REV | Sin Cuello | 25 | 1,63     |
| 86121-REV | Con Cuello | 25 | 1,71     |

En policarbonato  
 Según normas VDE, OVE y otras.

Negras

**Base Aerea Blanca con Toma-Tierra**

| Refer:    |  |    | Precio € |
|-----------|--|----|----------|
| 86120-REV |  | 25 | 1,71     |

En policarbonato  
 Según normas VDE, OVE y otras.

Blancas

**Estuche de terminales, 200 uds.**

**Refer:** 3160-PR **Precio €** 18,79

Surtido de 18 modelos diferentes

En estuche de plástico

**Alicate para terminales AISLADOS**

**Refer:** 3010-PR **Precio €** 4,93

Para terminales de 0.5 a 6 mm<sup>2</sup>

**Alicate para terminales SIN AISLAR**

**Refer:** 3020-PR **Precio €** 7,56

Para terminales de 0.5 a 6 mm<sup>2</sup>

**Alicate para terminales MIXTOS**

**Refer:** 3030-PR **Precio €** 6,94

Para terminales de 0.5 a 6 mm<sup>2</sup>

**Terminales Machos Desnudos**



| Refer:       | Descripción   | Medida    | Sección |     | Precio € |
|--------------|---------------|-----------|---------|-----|----------|
| 873272-ELM   | Macho Desnudo | 2.8 x 0.8 | 0.5 - 1 | 100 | 4,20     |
| 873272/B-ELM | Macho Desnudo | 4.8 x 0.8 | 0.5 - 1 | 100 | 7,41     |
| 873272/C-ELM | Macho Desnudo | 6.3 x 0.8 | 1 - 2.5 | 100 | 7,84     |



**Terminales Hembras Desnudas**



| Refer:        | Descripción    | Medida    | Sección |     | Precio € |
|---------------|----------------|-----------|---------|-----|----------|
| 27TLH2800-LER | Hembra Desnudo | 2.8 x 0.8 | 0,5 - 1 | 100 | 4,10     |
| 27TLH4800-LER | Hembra Desnudo | 4.8 x 0.8 | 0.5 - 1 | 100 | 5,40     |
| 27TLH6300-LER | Hembra Desnudo | 6.3 x 0.8 | 1 - 2,5 | 100 | 5,40     |





|  |  | Terminales Cerrados Pre-aislados |                  |             |            |   |          |
|---|--|----------------------------------|------------------|-------------|------------|---|----------|
|   |  | Refer:                           | Descripción      | Int - Ext   | Sección    |  | Precio € |
|   |  | 3206-ELM                         | Cerrado azul     | 3.7 x 8,7   | 1.50 - 2.5 | 100   | 6,90     |
|   |  | 3209-ELM                         | Cerrado azul     | 6.4 x 12    | 1.50 - 2.5 | 100   | 7,04     |
|   |  | 3208-ELM                         | Cerrado azul     | 8.4 x 12    | 1.50 - 2.5 | 100   | 7,12     |
|   |  | 3212-ELM                         | Cerrado azul     | 10.5 x 13.5 | 1.50 - 2.5 | 100   | 7,56     |
|   |  | 3213-ELM                         | Cerrado amarillo | 4.3 x 7.2   | 2.5 - 6    | 100   | 7,65     |
|   |  | 3214-ELM                         | Cerrado amarillo | 5.3 x 9.5   | 2.5 - 6    | 100   | 7,98     |

|  |  | Terminales Hembra Pre-aislados |             |           |           |   |          |
|---|--|--------------------------------|-------------|-----------|-----------|---|----------|
|   |  | Refer:                         | Descripción | Medida    | Sección   |  | Precio € |
|   |  | 3244-PR                        | Hembra rojo | 6.3 x 0.8 | 0.5 - 1.5 | 100   | 6,55     |
|   |  | 3246-PR                        | Hembra rojo | 4.8 x 0.8 | 0.5 - 1.5 | 100   | 5,99     |
|   |  | 3244/B-PR                      | Hembra rojo | 2.8 x 0.8 | 0.5 - 1.5 | 100   | 5,70     |
|   |  | 3248-PR                        | Hembra azul | 6.3 x 0.8 | 1.0 - 2.5 | 100   | 7,12     |
|   |  | 3248/B-PR                      | Hembra azul | 4.8 x 0.8 | 1.0 - 2.5 | 100   | 6,41     |

|  |  | Terminales Macho Pre-aislados |             |           |           |   |          |
|---|--|-------------------------------|-------------|-----------|-----------|---|----------|
|   |  | Refer:                        | Descripción | Medida    | Sección   |  | Precio € |
|   |  | 3270-PR                       | Macho rojo  | 6.3 x 0.8 | 0.5 - 1.5 | 100   | 6,08     |
|   |  | 3272/B-ELM                    | Macho rojo  | 4.8 x 0.8 | 0.5 - 1.5 | 100   | 5,34     |
|   |  | 3270/B-ELM                    | Macho rojo  | 2.8 x 0.8 | 0.5 - 1.5 | 100   | 4,97     |
|   |  | 3271-PR                       | Macho azul  | 6.3 x 0.8 | 1.0 - 2.5 | 100   | 6,30     |
|   |  | 3271/B-ELM                    | Macho azul  | 4.8 x 0.8 | 1.0 - 2.5 | 100   | 6,24     |

|  |  | Terminales Canuto Pre-aislados |             |        |           |   |          |
|---|--|--------------------------------|-------------|--------|-----------|---|----------|
|   |  | Refer:                         | Descripción | Medida | Sección   |  | Precio € |
|   |  | 3292-PR                        | Hembra rojo | M-4    | 0.5 - 1.5 | 100   | 10,38    |
|   |  | 3293-PR                        | Hembra azul | M-5    | 1.0 - 2.5 | 100   | 11,27    |

|  |  | Terminales Puntera Pre-aislados |             |        |           |   |          |
|---|--|---------------------------------|-------------|--------|-----------|---|----------|
|   |  | Refer:                          | Descripción | Medida | Sección   |  | Precio € |
|   |  | 3290-PR                         | Macho rojo  | M-4    | 0.5 - 1.5 | 100   | 7,12     |
|   |  | 3291-PR                         | Macho azul  | M-4    | 1.0 - 2.5 | 100   | 7,27     |
|   |  | 3291/B-PR                       | Macho azul  | M-5    | 1.0 - 2.5 | 100   | 10,28    |

| <b>Terminales Horquilla Pre-aislados</b> |                       |               |                |     |                 |  |
|--|-----------------------|---------------|----------------|-----|-----------------|--|
| <u>Refer:</u>                            | <u>Descripción</u>    | <u>Medida</u> | <u>Sección</u> |     | <u>Precio €</u> |  |
| 3223-PR                                  | Horquilla <b>rojo</b> | 3.2 x 6.4     | 0.5 - 1.5      | 100 | 8,32            |  |
| 3225-PR                                  | Horquilla <b>azul</b> | 3.7 x 6.8     | 1.0 - 2.5      | 100 | 9,98            |  |

| <b>Terminales Punta Fina Pre-aislados</b> |                     |               |                |     |                 |  |
|---|---------------------|---------------|----------------|-----|-----------------|--|
| <u>Refer:</u>                             | <u>Descripción</u>  | <u>Medida</u> | <u>Sección</u> |     | <u>Precio €</u> |  |
| 3280-PR                                   | Puntera <b>rojo</b> | M-1.7         | 0.5 - 1.5      | 100 | 10,76           |  |
| 3281-PR                                   | Puntera <b>azul</b> | M-2.3         | 1.0 - 2.5      | 100 | 10,76           |  |

| <b>Terminales Empalme Pre-aislados</b> |                        |               |                |     |                 |  |
|--|------------------------|---------------|----------------|-----|-----------------|--|
| <u>Refer:</u>                          | <u>Descripción</u>     | <u>Medida</u> | <u>Sección</u> |     | <u>Precio €</u> |  |
| 3294-PR                                | Cilíndrico <b>rojo</b> | M-4           | 0.5 - 1.5      | 100 | 6,19            |  |
| 3295-ELM                               | Cilíndrico <b>azul</b> | M-5           | 1.0 - 2.5      | 100 | 7,70            |  |

| <b>Terminales Hembra 100% Aislados</b> |                    |               |                |     |                 |  |
|--|--------------------|---------------|----------------|-----|-----------------|--|
| <u>Refer:</u>                          | <u>Descripción</u> | <u>Medida</u> | <u>Sección</u> |     | <u>Precio €</u> |  |
| 3244/C-PR                              | Hembra <b>rojo</b> | 6.3 x 0.8     | 0.5 - 1.5      | 100 | 6,55            |  |
| 3248/C-PR                              | Hembra <b>azul</b> | 6.3 x 0.8     | 1.0 - 2.5      | 100 | 8,55            |  |

| <b>Regletas de Conexión Blancas y Negras</b> |               |              |                |                 |                         |  |
|--|---------------|--------------|----------------|-----------------|-------------------------|--|
| <u>Refer</u>                                 | <u>Blanco</u> | <u>Negro</u> | <u>Medidas</u> | <u>Cantidad</u> | <u>Precio € Paquete</u> |  |
| 870403/                                      | ✓             | ✓            | 4 mm x 3 A     | 5 Tiras         | 1,90                    |  |
| 871204/                                      | ✓             | ✗            | 4 mm x 3 A     | 10 Tiras        | 3,80                    |  |
| 870606/                                      | ✓             | ✗            | 6 mm x 6 A     | 5 Tiras         | 2,45                    |  |
| 871215/                                      | ✓             | ✓            | 12 mm x 15 A   | 5 Tiras         | 4,30                    |  |
| 871420/                                      | ✓             | ✓            | 14 mm x 20 A   | 5 Tiras         | 4,50                    |  |
| 871632/                                      | ✓             | ✗            | 16 mm x 32 A   | 10 Tiras        | 19,38                   |  |

**Buscapolos de 125-250 V.**

**Refer:**  
3039D055-TOP

12



140

**Precio €**  
1,24

**Buscapolos Profesional 250 V.**

**Refer:**  
566/150-PAD  
566/190-PAD

10

150

10

190

**Precio €**  
2,98  
3,64

**Buscapolos de Pinza de 6-24 V.**

**Refer:**  
580-PR



135

**Precio €**  
2,47

**Buscapolos de Aguja de 6-24 V.**

**Refer:**  
585-PR



115

**Precio €**  
3,64



**Juego Puntas XZN cogida 10 mm, 11 pzs.**

**Refer:**  
210/01-PR

**Precio €**  
19,12

Puntas M5, M6, M8, M10 y M12 x 30 mm  
Puntas M5, M6, M8, M10 y M12 x 75 mm  
Adaptador 1/2 x 10 mm



**Juego Puntas HEX cogida 10 mm, 15 pzs.**

**Refer:**  
210/02-PR

**Precio €**  
20,58

Puntas 4, 5, 6, 7, 8, 10 y 12 x 30 mm  
Puntas 4, 5, 6, 7, 8, 10 y 12 x 75 mm  
Adaptador 1/2 x 10 mm



**Juego Puntas TORX cogida 10 mm, 11 pzs.**

**Refer:**  
210/03-PR

**Precio €**  
20,80

Puntas T20, T25, T30, T40, T45, T50 y T55 x 30 mm  
Puntas T20, T25, T30, T40, T45, T50 y T55 x 75 mm  
Adaptador 1/2 x 10 mm





**Puntas XZN, HEX y TORX**

**Refer:** cogida 10 mm 40 pzs. **Precio €**  
210/04-PR 45,58

XZN M5, M6, M8, M10 y M12 x 30 y 75 mm

HEX M4, M5, M6, M7, M8, M10 y M12 x 30 y 75 mm

TORX T20, T25, T30, T40, T45, T50 y T55 x 30 y 75 mm

Adaptadores de 1/2 x 10 mm y 3/8 x 10 mm



**Juego Puntas RIBE cogida 10 mm, 21 pzs.**

**Refer:** 210/05-UPO **Precio €**  
33,15

Puntas 5, 6, 7, 8, 9, 10, 11, 12 y 13 x 40 mm  
Puntas 5, 6, 7, 8, 9, 10, 11, 12, 13 y 14 x 75 mm  
Adaptadores de 1/2 x 10 mm y 3/8 x 10 mm



**Juego TORX INVOLABLE de 1/2", 19 pzs.**

**Refer:** 1008-PR **Precio €**  
58,60

Vasos 1/2":  
E10, E11, E12, E14, E16, E18 y E20, E22 y E24

Vasos-Punta de 1/2":  
T20, T25, T27, T30, T40, T45, T50, T55, T60 y T70





**Vasos TORX Hembra, 12 pzs.**

**Refer:**  
1006-PR

E4, E5, E6, E7 y E8 x 1/4"      E10, E11, E12, E14, E16, E18 y E20 x 3/8"

**1/4"**

**3/8"**

**Precio €**  
18,90



**Vasos-Punta TORX, 10 pzs.**

**Refer:**  
1004/1-PR

T7, T8, T9, T10, T15, T20, T25, T27, T30 y T40

**1/4"**

**Precio €**  
12,39



**Vasos-Punta TS 5 LADOS, 9 pzs.**

**Refer:**  
1108-PR

TS10, TS15, TS20, TS25, TS30, TS40, TS45 y TS50

**1/4"**

**Precio €**  
17,86



**Juegos de Vasos Hexagonales, Serie Larga**

**Refer:**

|            |  |                          |
|------------|--|--------------------------|
| 1009/14-PR | 4, 5, 5.5, 6, 7, 8, 9, 10, 11, 12, 13 - 1/4"     | <b>Precio €</b><br>25,42 |
| 1009/38-PR | 8, 10, 11, 12, 13, 14, 15, 16, 17, 18, 19 - 3/8" | 35,08                    |
| 1009/12-PR | 10, 13, 15, 17, 19, 22, 24 - 1/2"                | 44,74                    |

**1/4"**

**3/8"**

**1/2"**



**Juego de Vasos - Punta Torx, 4 pzs.**

**Refer:**  
5004-PR

TX-70, TX-80, TX-90, TX-100

En estuche de plástico

**1/2"**

**Precio €**  
39,79



**Juego de Vasos XZN de 1/2", 16 pzs.**

**Refer:**  
1016/12K-PR

**Precio €**  
36,76

8, 9, 10, 11, 12, 13, 14, 15, 16,  
17, 18, 19, 20, 21, 22 y 24 mm

En estuche de plástico



**Juego de Vasos TORX de 1/2", 9 pzs.**

**Refer:**  
1007-PR

**Precio €**  
28,36

E10, E11, E12, E14, E16, E18, E20, E22 y E24

En estuche de plástico



**Vasos de Impacto de 1/2", 10 pzs.**

**Refer:**  
1010/12-PR

**Precio €**  
36,34

10, 12, 13, 14, 15, 17, 19, 21, 22 y 24 mm



**Refer:**  
1010/12T-PR

**Precio €**  
59,86

10, 12, 13, 14, 15, 17, 19, 21, 22 y 24 mm



Serie Larga



**Caja de Puntas y Vasos Multiuso, 35 pzs.**

**Refer:**  
8334/35-UPO

**Precio €**  
90,55

- Vasos 3/8 de 6-7-8-9-10-11-12 y 13 mm
- Puntas XZN de 4-5-6-8 y 10 mm
- Puntas Torx Inv de 15-20-25-27-30-40 y 45.
- Puntas Hex de 4-5-6-7-8 y 10 mm
- Puntas Ribe de 5-6-8-10-12 y 13.
- Adaptador de 3/8 x 13 mm
- Carraca de 72 dientes cogida Bi-Hexagonal de 13 mm



**Estuche Puntas y Carraca reversible, 25 pzs.**

**Refer:**  
8335/25-WH

**Precio €**  
44,25

- Puntas XZN de 5-6-8 y 10 mm
- Puntas Torx de 10-15-20-25-27 y 30.
- Puntas Hex de 2.5-3-4-5-6-7-8 y 10 mm
- Puntas PH 1, 2, 3 y 4.
- Puntas Planas de 4 y 6.5 mm
- Carraca de 72 dientes cogida Bi-Hexagonal de 10 mm
- En estuche de plástico con cierre metálico.



**Mini Bomba de engrase manual**

**Refer:**  
3985-PR

**Precio €**  
26,23

- Depósito de 120 grs.
- Cuerpo de acero cromado.
- Latiguillo de engrase rígido de 170 mm.
- Latiguillo de engrase flexible de 230 mm.
- Barra extensora 115 mm + Boquillas



**Latiguillos y Boquillas para Bombas Engrase**

| Refer:    |                            | Precio € |
|-----------|----------------------------|----------|
| 3980/A-PR | Latiguillo flexible 300 mm | 7,35     |
| 3980/B-PR | Latiguillo flexible 480 mm | 8,75     |
| 3980/D-PR | Boquilla engrase 4 garras  | 3,32     |



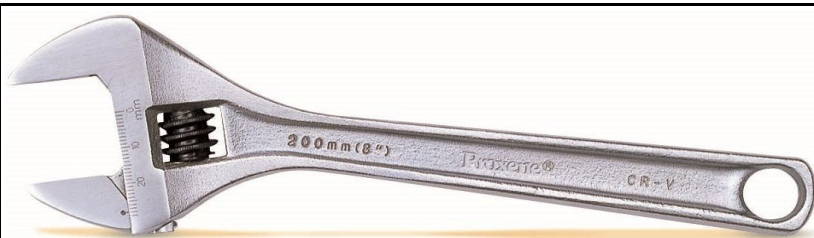

**Llave Inglesa ajustable Semiprofesional**

| Refer:     |     |   | Precio € |
|------------|-----|---|----------|
| 237/06-TOM | 6"  | 6 | 4,78     |
| 237/08-TOM | 8"  | 6 | 6,38     |
| 237/10-TOM | 10" | 6 | 7,75     |
| 237/12-TOM | 12" | 6 | 10,35    |
| 237/15-TOM | 15" | 6 | 24,45    |
| 237/18-TOM | 18" | 1 | 31,80    |
| 237/24-TOM | 24" | 1 | 59,75    |

**Llave Inglesa ajustable Profesional milimetrada FULCO**

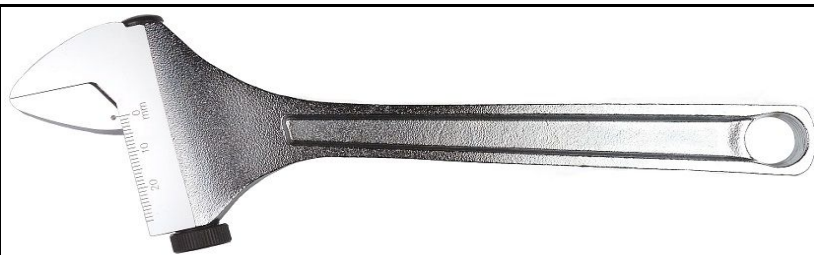
| Refer:      |     |    | Precio € |
|-------------|-----|----|----------|
| 241/06M-PRO | 6"  | 10 | 10,92    |
| 241/08M-PRO | 8"  | 12 | 13,86    |
| 241/10M-PRO | 10" | 12 | 17,45    |
| 241/12M-PRO | 12" | 5  | 21,77    |
| 241/15M-PRO | 15" | 1  | 46,76    |

**Llave Inglesa ajustable Moleta Lateral milimetrada FULCO**

| Refer:      |     |    | Precio € |
|-------------|-----|----|----------|
| 238/06C-PRO | 6"  | 12 | 16,63    |
| 238/08C-PRO | 8"  | 6  | 19,30    |
| 238/10C-PRO | 10" | 6  | 26,30    |

**Llave Inglesa ajustable Gran Apertura milimetrada Profesional**

| Refer:      |     |       |   | Precio € |
|-------------|-----|-------|---|----------|
| 239/06C-PRO | 6"  | 34 mm | 6 | 11,76    |
| 239/08C-PRO | 8"  | 39 mm | 6 | 15,60    |
| 239/10C-PRO | 10" | 50 mm | 6 | 23,76    |



**Remachadora Profesional**

**Refer:**  
235-PR

**Precio €**  
20,89

Para Remaches de: 2.4 - 3.2 - 4.0 - 4.8



**Remachadora Profesional en Estuche**

**Refer:**  
236-PR

**Precio €**  
28,86

Para Remaches de: 2.4 - 3.2 - 4.0 - 4.8

En estuche de plástico con 100 remaches



Especial para apriete de piezas de polietileno

**Llave Articulada Ajustable**

| <b>Refer:</b> | <b>Rango de apertura</b> | <b>Precio €</b> |
|---------------|--------------------------|-----------------|
| 4480/2-TOM    | 35 a 50 mm               | 16,99           |
| 4480/3-TOM    | 50 a 80 mm               | 30,25           |
| 4480/4-TOM    | 80 a 120 mm              | 37,20           |

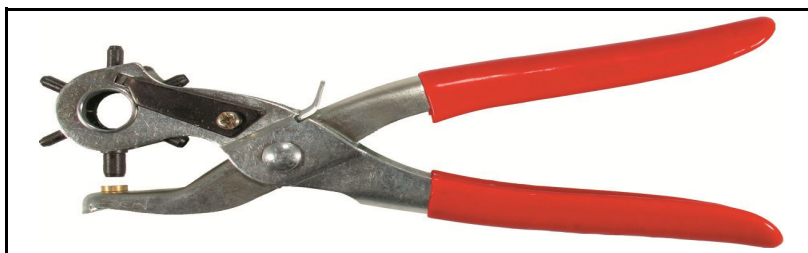

**Sacabocados Manual Bricolage**

**Refer:**  
268-PR

**Precio €**  
6,02

Ideal para plástico, goma, cuero, cartón, etc.

Mango Plastificado



**Sacabocados Manual Profesional**

**Refer:**  
3032D424-TOP



**Precio €**  
22,71

Ideal para plástico, goma, cuero, cartón, etc.

Mango Plastificado

Ø : 2 , 2.5 , 3 , 3.5 , 4 y 4.5 mm.



**Juego de Sacabocados de Golpe, 9p.**

**Refer:**  
80-PR

**Precio €**  
11,56

Ø : 2.5, 3, 4, 5, 6, 7, 8, 9 y 10 mm.

En estuche de plástico



**Juego de Numeradores de Golpe, 9 pzs.**

**Refer:** YT-6854      **Ø** 6 mm      **Precio €** 8,85



**Juego de Abecedarios de Golpe, 27 pzs.**

**Refer:** YT-6862      **Ø** 6 mm      **Precio €** 23,43  
6862-TOM      8 mm      24,15

**Carraca Mini Reversible de 1/4" para vasos y puntas**
**Refer:**
**967242-WH**

- Cuadradillo macho para llaves de vaso de 1/4"
- Hexágono hembra para puntas de atornillador de 1/4"

**Precio €**

7,96

**Carraca Bricolage 36 Dientes**
**Refer:**
**207/14CV-PR**

De 1/4" con mango forrado

**Precio €**

10,92

**207/38CV-PR**

De 3/8" con mango forrado

14,92

**207/12CV-PR**

De 1/2" con mango forrado

20,38

**Carraca de 1/2" Extensible**
**Refer:**
**1208/12-WH**
**Precio €**

43,47

Extensible de 305 a 445 mm

Carraca de 1/2" de 72 dientes

**Carraca de 3/4" Profesional**
**Refer:**
**22550-PR**
**Precio €**

98,39

Carraca de 3/4" de 36 dientes

**Llaves Dinamométricas**

| Refer:    | Descripción                             |      |               | Precio € |
|-----------|---|------|---------------|----------|
| 95/000-PR | De 0,1 a 0,5 K # De 1 a 5 Newtons/Metro | 1/4" | Cierre Rápido | 82,50    |
| 95/00-PR  | De 0,6 a 3 K # De 6 a 30 Newtons/Metro  | 1/4" | Cierre Rápido | 99,76    |
| 95/0-PR   | De 0,6 a 3 K # De 6 a 30 Newtons/Metro  | 3/8" | Cierre Rápido | 99,76    |
| 95/2-PR   | De 4 a 21 K # De 40 a 210 Newtons/Metro | 1/2" | Cierre Rápido | 117,20   |
| 95/3-PR   | De 7 a 35 K # De 70 a 350 Newtons/Metro | 1/2" | Cierre Rápido | 121,50   |

**Goniómetro con cogida de 1/2"**

**Refer:**  
98-PR

**Precio €**  
13,51

Medición de 0 a 360°

Medidor de ángulo para llave dinamométrica o carraca.

Mide el ángulo de rotación después del par de torsión.



**Barras de Termofusión Transparentes**

| Refer:     |                              | Medida           | Precio € |
|------------|------------------------------|------------------|----------|
| 3173260-YT | Blíster con 12 barras        | 7 mm x 100 mm    | 1,78     |
| 3173271-YT | Blíster con 12 barras        | 11,2 mm x 150 mm | 5,25     |
| 104100-BM  | Bolsa con 50 barras (1 kilo) | 11,2 mm x 200 mm | 19,06    |

**Pistolas de Termofusión**

| Refer:       | Ø       | Potencia | Precio € |
|--------------|---------|----------|----------|
| 3042E581-TOP | 7 mm    | 10 W     | 5,74     |
| 3042E500-TOP | 11,2 mm | 40 W     | 7,05     |



**Pata de Cabra Octogonal**

| Refer:   | mm                           | Precio € |
|----------|------------------------------|----------|
| 81/1-TOM | 16 x 20 x 28 x <b>450</b> mm | 6,43     |
| 81/2-TOM | 16 x 27 x 31 x <b>600</b> mm | 9,80     |
| 81/3-TOM | 18 x 30 x 34 x <b>800</b> mm | 13,60    |

**Palanqueta Arquetas Engomada**

| Refer:   | mm     | Precio € |
|----------|--------|----------|
| 2431-TOM | 350 mm | 6,22     |



**Palanqueta Grapas Clips**

| Refer:   | mm     | Precio € |
|----------|--------|----------|
| 15409-WH | 200 mm | 7,72     |

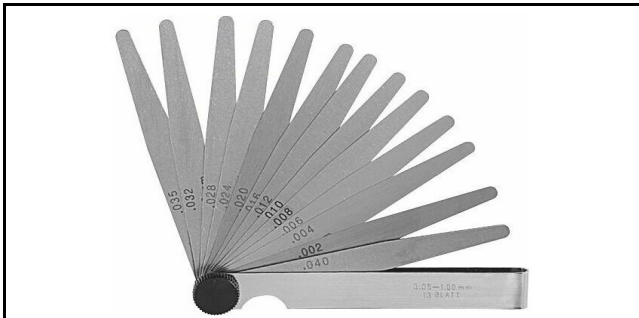

**Desmontadores de Cubiertas**

| Refer:     | mm   | Precio € |
|------------|--|----------|
| 165/250-PR | 19 mm de ancho x 6 mm de espesor x <b>250</b> mm de largo  | 7,14     |
| 165/300-PR | 23 mm de ancho x 8 mm de espesor x <b>300</b> mm de largo  | 7,85     |
| 165/400-PR | 23 mm de ancho x 8 mm de espesor x <b>400</b> mm de largo  | 8,50     |
| 165/500-HR | 23 mm de ancho x 8 mm de espesor x <b>500</b> mm de largo  | 9,40     |
| 165/600-HR | 26 mm de ancho x 11 mm de espesor x <b>600</b> mm de largo | 10,30    |



**Galgas de espesores**

| Refer: |                             | Precio € |
|--------|-----------------------------|----------|
| 171-PR | 13 galgas de 0.05 a 1.00 mm | 4,22     |
| 172-PR | 20 galgas de 0.05 a 1.00 mm | 6,75     |

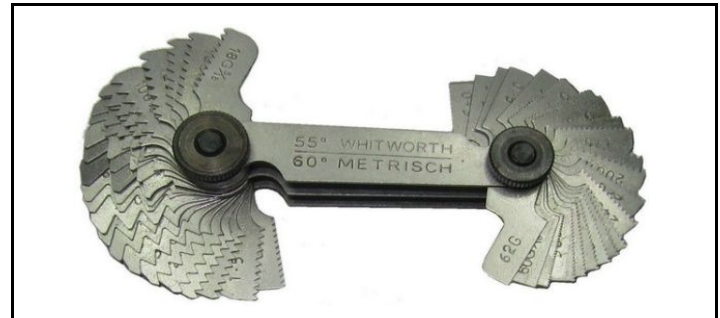

**Medidores de roscas**

| Refer: |                             | Precio € |
|--------|-----------------------------|----------|
| 184-PR | 24 hojas de Métrica         | 7,14     |
| 185-PR | 52 hojas Métrica y Pulgadas | 11,56    |



**Llave de 3 garras para Filtros de Aceite**

| Refer: |  | Precio € |
|--------|--|----------|
| 251-PR | * Para Filtros de 65 a 130 mm<br>* Incluye Hexágono de 21 mm<br>* Cogida de 3/8" + Adaptador de 1/2" | 15,15    |

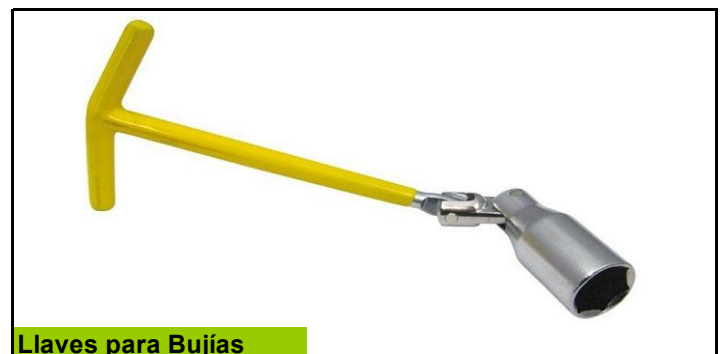

**Llaves para Bujías**

| Refer:     | Medidas              | Precio € |
|------------|----------------------|----------|
| 245/16-TOM | Para bujías de 16 mm | 4,84     |
| 245/21-TOM | Para bujías de 21 mm | 4,95     |



**Extractores de Tornillos rotos**

| Refer:     |                   | Precio € |
|------------|-------------------|----------|
| 101115-TOM | 5 pzs De M3 a M18 | 5,04     |
| 176/T-PR   | 6 pzs De M3 a M24 | 7,17     |

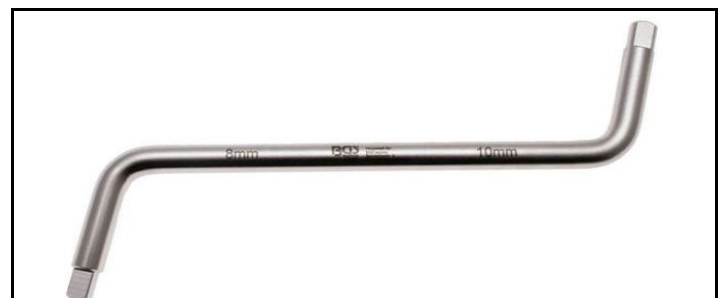

**Llave Cuadrado para Cártter Acodada**

| Refer: | Medidas   | Precio € |
|--------|-----------|----------|
| 260-PR | 8 - 10 mm | 7,36     |



**Llave de Fleje Metálico para Filtros**

| Refer:     | Precio € |
|------------|----------|
| 3157610-YT | 8,81     |

Longitud  
200 mm

Rango apertura  
55 mm - 110 mm



**Fresa Metal Duro Cilíndrica**

**Refer:**  
444/01-TOM Tipo A 12 x 25 x 65

**Precio €**  
18,94

**Fresa Metal Duro Cilíndrica Esférica**

**Refer:**  
444/02-TOM Tipo C 12 x 25 x 65

**Precio €**  
18,94

**Fresa Metal Duro Esférica**

**Refer:**  
444/03-TOM Tipo D 12 x 10 x 51

**Precio €**  
16,75

**Fresa Metal Duro Oval**

**Refer:**  
444/04-TOM Tipo E 12 x 20 x 65

**Precio €**  
18,22

**Fresa Metal Duro Ojival**

**Refer:**  
444/05-TOM Tipo F 12 x 25 x 65

**Precio €**  
18,94

**Fresa Metal Duro Cónica**

**Refer:**  
444/06-TOM Tipo M 12 x 25 x 65

**Precio €**  
18,22

**Fresa Metal Duro Cilíndrica Corte**

**Refer:**  
444/07-TOM Tipo B 12 x 25 x 65

**Precio €**  
18,94



\* Especial bombillos

**Fresa Metal Duro Cilíndrica Esférica**

**Refer:**  
444/08-TOM Tipo C 6 x 16 x 56

**Precio €**  
14,85



**Juegos de Machos de Roscar HSS-G Rectificados**

| Refer:    |            |         | Precio € |
|-----------|------------|---------|----------|
| 155/03-PR | M3 x 0.5   | 2,5 mm  | 7,68     |
| 155/04-PR | M4 x 0.7   | 3,3 mm  | 7,68     |
| 155/05-PR | M5 x 0.8   | 4,2 mm  | 8,25     |
| 155/06-PR | M6 x 1.00  | 5,0 mm  | 9,52     |
| 155/07-PR | M7 x 1.00  | 6,0 mm  | 9,96     |
| 155/08-PR | M8 x 1.25  | 6,8 mm  | 10,23    |
| 155/10-PR | M10 x 1.50 | 8,5 mm  | 14,86    |
| 155/12-PR | M12 x 1.75 | 10,2 mm | 16,93    |
| 155/14-PR | M14 x 2.00 | 12,0 mm | 25,03    |
| 155/16-PR | M16 x 2.00 | 14,0 mm | 33,64    |

**Giramachos en T con Carraca Reversibles**

| Refer:   |                       | L mm | Precio € |
|----------|-----------------------|------|----------|
| 159/1-PR | M3 - M10 1/8" - 3/8"  | 85   | 11,45    |
| 159/2-PR | M5 - M12 7/32" - 1/2" | 115  | 13,56    |

Para roscados de izquierda y de derecha

Mango corredizo

**Giramachos Manual DIN 1814**

| Refer:     |            | L mm | Precio € |
|------------|------------|------|----------|
| 157/12-TOM | M1,5 - M12 | 185  | 4,07     |

**Terraja Circular Hss DIN 223**

| Refer:     |                 | Precio € |
|------------|-----------------|----------|
| 158/04-TOM | M4 x 0,7 x 20   | 5,05     |
| 158/05-TOM | M5 x 0,8 x 20   | 5,05     |
| 158/06-TOM | M6 x 1,0 x 20   | 5,05     |
| 158/08-TOM | M8 x 1,25 x 25  | 5,85     |
| 158/10-TOM | M10 x 1,50 x 30 | 11,42    |
| 158/12-TOM | M12 x 1,75 x 38 | 17,80    |

**Giraterrajas Manual DIN 225**

| Refer:     |                     | L mm | Precio € |
|------------|---------------------|------|----------|
| 153/01-TOM | M3 - M4 x 20 x 5    | 175  | 5,32     |
| 153/02-TOM | M4,5 - M6 x 20 x 7  | 175  | 4,84     |
| 153/03-TOM | M7 - M9 x 25 x 9    | 210  | 6,08     |
| 153/04-TOM | M10 - M11 x 30 x 11 | 260  | 9,43     |
| 153/05-TOM | M12 - M14 x 38 x 14 | 310  | 12,60    |

**Juego Machos Combinados Hss-G, 7 p.**

**Refer:** 151-TOM

**Precio €** 53,55

M3 - M4 - M5 - M6 - M8 - M10 + Adaptador

**Machos Combinados Hss-G**

| Refer:     |     | Precio € |
|------------|-----|----------|
| 151/03-TOM | M3  | 8,10     |
| 151/04-TOM | M4  | 8,35     |
| 151/05-TOM | M5  | 8,55     |
| 151/06-TOM | M6  | 9,25     |
| 151/08-TOM | M8  | 9,75     |
| 151/10-TOM | M10 | 10,50    |

**Juego de Machos y Terrajas, 20 p.**

**Refer:** 154/20-TOM

**Precio €** 28,93

Machos y Terrajas de M3 a M12

Giramachos y Giraterajas de 200 mm

Material: Acero al Carbono

**Calidad Bricolage**

**Juego de Machos y Terrajas, 32 p.**

**Refer:** 154/32-TOM

**Precio €** 83,05

Machos y Terrajas de M3 a M12

Giramachos de 180 mm y Giraterajas de 200 mm

Medidor de Roscas Métrico

Destornillador Plano

Material: Hss-G

Estuche Metálico

**Calidad Profesional**

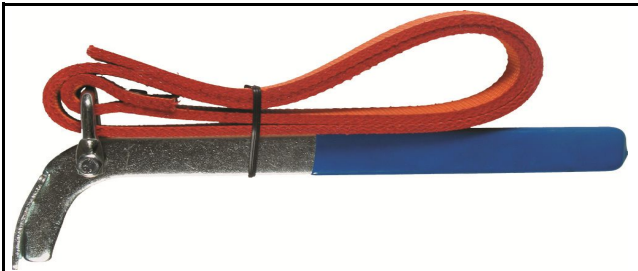
**Llave de Cuero para Filtros de Aceite**

Refer: 257-PR Largo cinta: 720 mm Precio € 12,18

**Llave de Cadena para Filtros de Aceite**

Refer: 93-PR Largo cadena: 300 mm Precio € 4,58

**Botadores Cilíndricos**

| Refer:      | Medidas        | Precio € |
|-------------|----------------|----------|
| 271/02-ELO  | 2 x 140 x 40   | 5,60     |
| 271/03-ELO  | 3 x 150 x 40   | 5,81     |
| 271/035-ELO | 3,5 x 150 x 40 | 6,75     |
| 271/04-ELO  | 4 x 190 x 40   | 7,82     |
| 271/05-ELO  | 5 x 200 x 50   | 7,92     |
| 271/06-ELO  | 6 x 210 x 50   | 8,25     |
| 271/08-ELO  | 8 x 215 x 50   | 8,50     |
| 271/09-ELO  | 9 x 150 x 50   | 8,75     |

**Juego de Botadores, 6p.**

Refer: 659-PR Medidas 3, 4, 5, 6, 7 y 8 mm x 150 mm Precio € 18,48

**Granetes Cónicos**

| Refer:       | Medidas    | Precio € |
|--------------|------------|----------|
| 3003A441-TOP | 6,3 x 100  | 2,20     |
| 3003A442-TOP | 9,4 x 127  | 2,70     |
| 3003A445-TOP | 12,7 x 152 | 3,75     |

**Avellanador Metal Hss**

| Refer:     | Ø       | Precio € |
|------------|---------|----------|
| 447/06-TOM | 6,3 mm  | 4,28     |
| 447/08-TOM | 8,3 mm  | 5,49     |
| 447/10-TOM | 10,4 mm | 5,95     |

**Avellanador Madera con Broca**

| Refer:    | Ø Tornillos | Precio € |
|-----------|-------------|----------|
| 100106-WH | 3 - 3,5 mm  | 6,87     |
| 100108-WH | 4 - 4,5 mm  | 6,87     |

**Avellanador Madera 90° de 5 Cortes**

| Refer:     | Ø     | Precio € |
|------------|-------|----------|
| 446/16-TOM | 16 mm | 4,18     |



**Juego de Vasos-Punta Hex PULGADAS, 7 pzs.**

Refer:  
5107-PR

Precio €  
14,92

**3/8"**

mm  
1/8, 5/32, 3/16, 7/32, 1/4, 5/16 y 3/8



**Juego de Vasos PULGADAS Largos, 10 pzs.**

Refer:  
21212-PR

Precio €  
19,44

**1/4"**

mm  
5/32, 3/16, 7/32, 1/4, 9/32, 5/16,  
11/32, 3/8, 7/16 y 1/2



**Juego de Vasos PULGADAS, 11 pzs.**

Refer:  
21211-PR

Precio €  
12,77

**1/4"**

mm  
3/16, 7/32, 1/4, 9/32, 5/16, 11/32,  
3/8, 13/32, 7/16, 15/32 y 1/2



**Juego de Vasos PULGADAS, 24 pzs.**

Refer:  
1194-PR

Precio €  
58,54

**1/4"**

mm  
5/32, 3/16, 7/32, 1/4, 9/32, 5/16, 11/32,  
3/8, 13/32, 7/16 y 15/32

**1/2"**

1/2, 9/16, 19/32, 5/8, 11/16, 3/4, 13/16,  
7/8, 15/16, 1, 1.1/16, 1.1/8 y 1.1/4







Acabado: Niquelado

Material: Acero Cromo Vanadio Templado



**Llaves Allen Acodadas calidad "Profesional"**

| Refer:    |  |  |  |  | Precio € |
|-----------|---|---|---|---|----------|
| 58/015-WH | 1,5   | 46  | 15  | 10  | 0,58     |
| 58/02-WH  | 2   | 51  | 18  | 10  | 0,67     |
| 58/025-WH | 2,5   | 57  | 20  | 10  | 0,77     |
| 58/03-WH  | 3   | 64  | 23  | 10  | 0,84     |
| 58/04-WH  | 4   | 72  | 29  | 10  | 1,23     |
| 58/05-WH  | 5   | 83  | 33  | 10  | 1,58     |
| 58/06-WH  | 6   | 94  | 38  | 10  | 1,85     |
| 58/07-WH  | 7   | 95  | 34  | 10  | 2,65     |
| 58/08-WH  | 8   | 105   | 44  | 10  | 2,77     |
| 58/09-WH  | 9   | 114   | 47  | 10  | 3,29     |
| 58/10-WH  | 10  | 122   | 50  | 5   | 4,33     |
| 58/11-WH  | 11  | 129   | 53  | 5   | 4,75     |
| 58/12-WH  | 12  | 134   | 57  | 5   | 6,82     |
| 58/13-TOP | 13  | 145   | 63  | 3   | 7,77     |
| 58/14-WH  | 14  | 151   | 70  | 3   | 10,70    |
| 58/17-WH  | 17  | 173   | 80  | 3   | 16,96    |
| 58/19-WH  | 19  | 195   | 89  | 3   | 19,57    |
| 58/22-WH  | 22  | 217   | 102   | 3   | 22,35    |



**Juego Llaves Allen en Anilla, 10 pzs**

Refer: 168/B-UPO

1.5, 2, 2.5, 3, 4, 5, 5.5, 6, 8 y 10 mm







**Precio €**  
4,82



**Llaves HEX tipo Navaja, 8 pzs**

Refer: 3035D958-TOP

Hex 1, 1.5, 2, 2.5, 3, 4, 5, 5.5 y 6 mm

**Precio €**  
6,43



**Llaves Allen Bola Largas en PULGADAS, 9 pzs**

Refer: 1121Z-PR

1/16, 5/64, 3/32, 1/8, 5/32, 3/16, 1/4, 5/16 y 3/8

9 Piezas

**Precio €**  
17,22



**Llaves TORX Inviolables, 10 pzs**

**Refer:**  
165/110-FLY

**Precio €**  
18,62

T10-15-20-25-27-30-40-45-50 y 55

Estuche Metálico



**Llaves TORX tipo Navaja, 8 pzs**

**Refer:**  
3035D959-TOP

**Precio €**  
6,47

TX 9, 10, 15, 20, 25, 27, 30 y 40



**Llaves TORX INV - ALLEN acodadas, 18 pzs**

**Refer:**  
169-TOM

**Precio €**  
17,52

TX 10, 15, 20, 25, 27, 30, 40, 45 y 50

1.5, 2, 2.5, 3, 4, 5, 6, 8 y 10 mm



En estuche de plástico rígido y resistente



**Llaves XZN acodadas "Elora"**

Calidad: Cr 50 V 4

| Refer:     |     |    |      | Precio € |
|------------|-----|----|------|----------|
| 160/05-ELO | 72  | 25 | M-5  | 3,55     |
| 160/06-ELO | 80  | 28 | M-6  | 4,36     |
| 160/12-ELO | 112 | 40 | M-12 | 7,98     |



**Llaves RIBE acodadas "Elora"**

Calidad: Cr 50 V 4

| Refer:     |     |    |      | Precio € |
|------------|-----|----|------|----------|
| 161/04-ELO | 60  | 20 | M-4  | 3,00     |
| 161/10-ELO | 100 | 36 | M-10 | 6,82     |
| 161/12-ELO | 112 | 40 | M-12 | 8,40     |



**Llaves TORX INVOLABLES acodadas**

Calidad: Acero S2

| Refer:       |     |    |      | Precio € |
|--------------|-----|----|------|----------|
| 162/TTX08-WH | 50  | 15 | T-8  | 2,46     |
| 162/TTX09-WH | 55  | 18 | T-9  | 2,50     |
| 162/TTX10-WH | 60  | 20 | T-10 | 2,52     |
| 162/TTX15-WH | 64  | 22 | T-15 | 2,64     |
| 162/TTX20-WH | 68  | 23 | T-20 | 2,95     |
| 162/TTX25-WH | 72  | 24 | T-25 | 3,34     |
| 162/TTX27-WH | 78  | 25 | T-27 | 3,63     |
| 162/TTX30-WH | 83  | 26 | T-30 | 3,75     |
| 162/TTX40-WH | 89  | 28 | T-40 | 3,98     |
| 162/TTX45-WH | 96  | 31 | T-45 | 4,63     |
| 162/TTX50-WH | 105 | 35 | T-50 | 5,86     |



**Llaves TORX acodadas "Elora"**

Calidad: Cr 50 V 4

| Refer:         |      |      |           | Precio € |
|----------------|------|------|-----------|----------|
| 162/TX07-ELO   | 50,5 | 18,5 | T-7       | 3,95     |
| 162/TXKU10-ELO | 80   | 19   | T-10 Bola | 3,37     |
| 162/TX27-ELO   | 70   | 26,5 | T-27      | 3,46     |
| 162/TXKU27-ELO | 105  | 24   | T-27 Bola | 3,95     |



**Llaves TS de 5 LADOS Largas Acodadas**

| Refer:      | Precio € |
|-------------|----------|
| 1124/EL9-PR | 28,36    |



Inviolables

TS10-15-20-25-27-30-40-45 y 50

9 piezas



**Espejo Flexible de Inspección**

Refer: 3568-PR

∅ 55 mm

↔ 500 mm

Precio € 8,43



**Imán Flexibles con Mango**

Refer: 374/A-PR

0,5 kg

↔ 510 mm

Precio € 7,90



**Imán Extensible**

Refer: 373/A-PR

Capacidad Imán: 1,6 kg.  
Largo recogido: 170 mm.  
Largo extendido: 760 mm.

Precio € 8,93



**Imán Extensible con Punta**

Refer: 372-PR

Capacidad Imán: 0,5 kg.  
Largo recogido: 150 mm.  
Largo extendido: 650 mm.

Precio € 5,99



**Punta Grabadora Metálica**

Refer: 3740-TOM

Longitud: 145 mm.  
Clip para bolsillo.

Precio € 4,95



**Garra Flexible**

Refer: 427-PR

↔ 600 mm

Precio € 2,83







**Juego de Vasos VARIOPLUS 1/4", 13 pzs**

Refer: **2113-PR** Precio € **17,55**

**Especiales para: Hex - Hex Pulgadas - Torx - XZN**

| Mm     | Pulgadas | Torx |
|--------|----------|------|
| 4 mm   | 5/32"    | E 5  |
| 4,5 mm |          | E 6  |
| 5 mm   | 3/16"    |      |
| 5,5 mm |          |      |
| 6 mm   |          | E 8  |
| 7 mm   | 9/32"    |      |
| 8 mm   | 5/16"    | E 10 |
| 9 mm   | 11/32"   |      |
| 10 mm  | 3/8"     | E 12 |
| 11 mm  | 7/16"    | E 14 |
| 12 mm  | 15/32"   | E 16 |
| 13 mm  | 1/2"     |      |
| 14 mm  |          | E 18 |



**Juego de Vasos VARIOPLUS 1/2", 16 pzs**

Refer: **2116-PR** Precio € **52,30**

**Especiales para: Hex - Hex Pulgadas - Torx - XZN**

| Mm    | Pulgadas | Torx |
|-------|----------|------|
| 8 mm  | 5/16"    | E 10 |
| 9 mm  | 11/32"   |      |
| 10 mm | 3/8"     | E 12 |
| 11 mm | 7/16"    | E 14 |
| 12 mm | 15/32"   | E 16 |
| 13 mm | 1/2"     |      |
| 14 mm |          | E 18 |
| 15 mm | 19/32"   |      |
| 16 mm | 5/8"     | E 20 |
| 17 mm |          |      |
| 18 mm |          | E 22 |
| 19 mm | 3/4"     | E 24 |
| 20 mm | 25/32"   |      |
| 21 mm | 13/16"   |      |
| 22 mm | 7/8"     |      |
| 24 mm | 15/16"   |      |



**Vasos BANLIN Hex / Pulgadas / Torx / Xzn de 1/2"**



| Refer:      | Métrica | Pulgadas | Equivalente a TX | Precio € |
|-------------|---------|----------|------------------|----------|
| 1633/10C-WH | 10 mm   | 3/8      | E-12             | 3,00     |
| 1633/11C-WH | 11 mm   | 7/16     | E-14             | 3,00     |
| 1633/12C-WH | 12 mm   | 15/32    |                  | 3,00     |
| 1633/13C-WH | 13 mm   | 1/2      | E-16             | 3,00     |
| 1633/14C-WH | 14 mm   | 9/16     | E-18             | 3,00     |
| 1633/15C-WH | 15 mm   | 19/32    |                  | 3,05     |
| 1633/16C-WH | 16 mm   | 5/8      | E-20             | 3,05     |
| 1633/17C-WH | 17 mm   | 21/32    |                  | 3,23     |
| 1633/18C-WH | 18 mm   | 11/16    | E-22             | 3,42     |
| 1633/19C-WH | 19 mm   | 3/4      | E-24             | 3,42     |
| 1633/24-WH  | 24 mm   | 15/16    |                  | 5,07     |

**Especiales para: Hex - Hex Pulgadas - Torx - XZN**



**Extractores de Rodamientos de 2 Brazos**

| Refer:     | Medidas              | Precio € |
|------------|----------------------|----------|
| 141/075-PR | De 2 brazos x 75 mm  | 7,63     |
| 141/100-PR | De 2 brazos x 100 mm | 11,31    |
| 141/150-PR | De 2 brazos x 150 mm | 17,83    |



**Extractores de Rodamientos de 3 Brazos**

| Refer:     | Medidas              | Precio € |
|------------|----------------------|----------|
| 142/075-PR | De 3 brazos x 75 mm  | 10,24    |
| 142/100-PR | De 3 brazos x 100 mm | 16,33    |
| 142/150-PR | De 3 brazos x 150 mm | 25,66    |

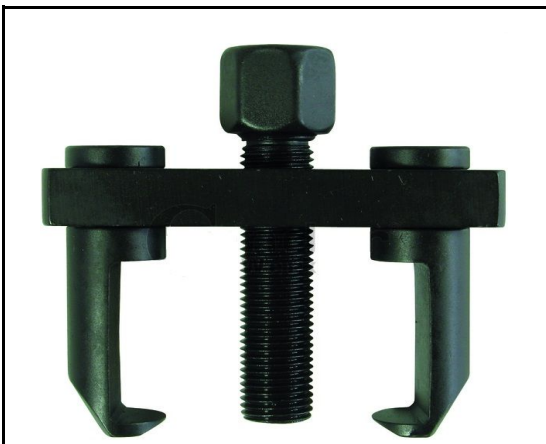

**Extractor 2 Patas Especial**

| Refer:  | Medidas            | Precio € |
|---------|--------------------|----------|
| 4588-PR | Vw-Audi-Seat-Skoda | 33,05    |



**Extractor 2 Patas Finas**

| Refer:  | Medidas | Precio € |
|---------|---------|----------|
| 3555-PR |         | 23,50    |



**Llave de Cruz para Ruedas**

**Refer:**  
87/3-TOM

**Precio €**  
12,05

**Medidas**  
17 mm x 19 mm x 21 mm x 23 mm

**Longitud**  
350 mm

**Diámetro**  
16 mm

**DIN 899**



**Llave de Rueda Extensible**

**Refer:**  
670231

**Precio €**  
16,95

Con vaso doble de 1/2" (17x19 y 21x23 mm)

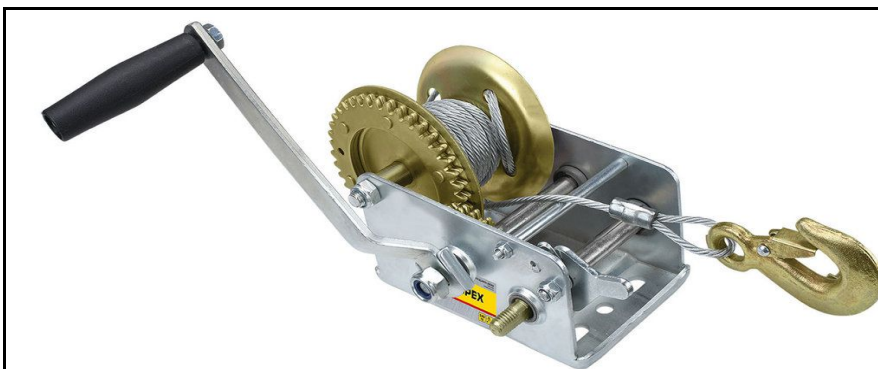

**Tráctel con Cable de Arrastre**

**Refer:**  
3097X085-TOP  
3097X087-TOP

540 kg  
900 kg

**Precio €**  
52,95  
67,88

Especialmente indicado para los basculantes de los remolques.

10 mts



|       |        |      |
|-------|--------|------|
| 10 mm | 3/8"   | E 12 |
| 11 mm | 7/16"  | E 14 |
| 12 mm | 15/32" | E 16 |
| 13 mm | 1/2"   |      |
| 14 mm | 9/16"  | E 18 |
| 15 mm | 19/32" |      |
| 16 mm | 5/8"   | E 20 |
| 17 mm | 21/32" |      |
| 18 mm | 11/16" | E 22 |
| 19 mm | 3/4"   | E 24 |

**Juego BANLIN, Vasos, Llaves, Vasos-Punta y Carracas, 68 pzs**

Refer: 16310/68-WH

Precio € 212,91



**Juego Llaves Mixtas BANLIN, 8 pzs**

Refer: 16313/08-WH En funda de lona Precio € 64,10

Hexagonal: de 8 a 19 mm.  
Hex Pulgadas: de 5/16" a 3/4".  
Torx: de E10 a E24.



**Juego Llaves Mixtas BANLIN, 8 pzs**

Refer: 16301/08-WH En estuche de plástico Precio € 58,92

Hexagonal: de 8 a 19 mm.  
Hex Pulgadas: de 5/16" a 3/4".  
Torx: de E10 a E24.



**1/4"**
**Vasos Hexagonales de 1/4"**

| Refer:    | mm  | Precio € |
|-----------|-----|----------|
| 200/4-PR  | 4   | 1,37     |
| 200/45-PR | 4.5 | 1,37     |
| 200/5-PR  | 5   | 1,37     |
| 200/55-PR | 5.5 | 1,37     |
| 200/6-PR  | 6   | 1,37     |
| 200/7-PR  | 7   | 1,37     |
| 200/8-PR  | 8   | 1,37     |
| 200/9-PR  | 9   | 1,43     |
| 200/10-PR | 10  | 1,43     |
| 200/11-PR | 11  | 1,43     |
| 200/12-PR | 12  | 1,43     |
| 200/13-PR | 13  | 1,57     |
| 200/14-PR | 14  | 1,74     |

**3/8"**
**Vasos Hexagonales de 3/8"**

| Refer:    | mm | Precio € |
|-----------|----|----------|
| 199/08-PR | 8  | 1,69     |
| 199/09-PR | 9  | 1,69     |
| 199/10-PR | 10 | 1,69     |
| 199/11-PR | 11 | 1,72     |
| 199/12-PR | 12 | 1,72     |
| 199/13-PR | 13 | 1,72     |
| 199/14-PR | 14 | 1,96     |
| 199/15-PR | 15 | 1,96     |
| 199/16-PR | 16 | 2,16     |
| 199/17-PR | 17 | 2,40     |

**1/2"**
**Vasos Hexagonales de 1/2"**

| Refer:      | mm | Precio € |
|-------------|----|----------|
| 201/08-PR   | 8  | 3,42     |
| 201/09-PR   | 9  | 3,47     |
| 201/10-PR   | 10 | 3,51     |
| 201/11-PR   | 11 | 3,51     |
| 201/12-PR   | 12 | 3,80     |
| 201/13-PR   | 13 | 3,86     |
| 201/14SL-PR | 14 | 3,86     |
| 201/15-PR   | 15 | 4,15     |
| 201/16-PR   | 16 | 4,15     |
| 201/17-PR   | 17 | 4,26     |
| 201/18SL-PR | 18 | 4,26     |
| 201/19-PR   | 19 | 4,38     |
| 201/20-PR   | 20 | 4,38     |
| 201/21-PR   | 21 | 4,38     |
| 201/22SL-PR | 22 | 4,42     |
| 201/23-PR   | 23 | 5,15     |
| 201/24-PR   | 24 | 5,15     |
| 201/25SL-PR | 25 | 5,15     |
| 201/26SL-PR | 26 | 5,15     |
| 201/27-PR   | 27 | 6,09     |
| 201/28-PR   | 28 | 6,09     |
| 201/29-PR   | 29 | 6,09     |
| 201/30SL-PR | 30 | 6,37     |
| 201/32-PR   | 32 | 6,37     |
| 201/34-PR   | 34 | 8,46     |
| 201/35-PR   | 35 | 11,86    |
| 201/36-PR   | 36 | 14,80    |

**3/4"**
**Vasos Hexagonales de 3/4"**

| Refer:      | mm | Nº Lados | Precio € |
|-------------|----|----------|----------|
| 771/19-PR   | 19 | 6        | 8,70     |
| 771/22-PR   | 22 | 6        | 8,70     |
| 771/23-PR   | 23 | 6        | 9,13     |
| 771/24-PR   | 24 | 6        | 9,13     |
| 771/26-PR   | 26 | 6        | 9,37     |
| 771/27-PR   | 27 | 6        | 9,37     |
| 771/28-PR   | 28 | 6        | 10,00    |
| 771/30-PR   | 30 | 6        | 10,24    |
| 771/32-PR   | 32 | 6        | 11,11    |
| 771/34-PR   | 34 | 6        | 12,93    |
| 771/36-PR   | 36 | 6        | 13,28    |
| 3008326-TOP | 36 | 12       | 16,66    |
| 771/38-PR   | 38 | 6        | 16,76    |
| 3008327-TOP | 38 | 12       | 16,66    |
| 771/41-PR   | 41 | 6        | 17,28    |
| 771/46-PR   | 46 | 6        | 18,50    |
| 771/48-PR   | 48 | 6        | 19,29    |
| 771/50-PR   | 50 | 6        | 23,29    |
| 771/55-PR   | 55 | 6        | 29,79    |
| 771/60-PR   | 60 | 6        | 34,29    |

**1/4"**
**Vasos 1/4" Serie Larga**

| Refer:        | mm  | Precio € |
|---------------|-----|----------|
| 1009/1404-PR  | 4   | 2,47     |
| 1009/1405-PR  | 5   | 2,47     |
| 1009/14055-PR | 5,5 | 2,47     |
| 1009/1406-PR  | 6   | 2,50     |
| 1009/1407-PR  | 7   | 2,50     |
| 1009/1408-PR  | 8   | 3,12     |
| 1009/1409-PR  | 9   | 3,12     |
| 1009/1410-PR  | 10  | 3,12     |
| 1009/1411-PR  | 11  | 3,30     |
| 1009/1412-PR  | 12  | 3,46     |
| 1009/1413-PR  | 13  | 3,63     |

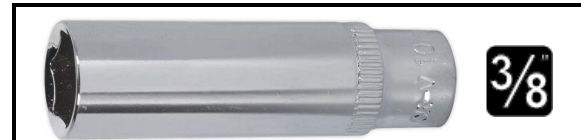
**3/8"**
**Vasos 3/8" Serie Larga**

| Refer:       | mm | Precio € |
|--------------|----|----------|
| 1009/3808-PR | 8  | 3,21     |
| 1009/3810-PR | 10 | 3,21     |
| 1009/3811-PR | 11 | 3,46     |
| 1009/3812-PR | 12 | 3,79     |
| 1009/3813-PR | 13 | 3,79     |
| 1009/3814-PR | 14 | 3,79     |
| 1009/3815-PR | 15 | 3,79     |
| 1009/3816-PR | 16 | 3,79     |
| 1009/3817-PR | 17 | 4,62     |
| 1009/3818-PR | 18 | 4,62     |
| 1009/3819-PR | 19 | 4,94     |

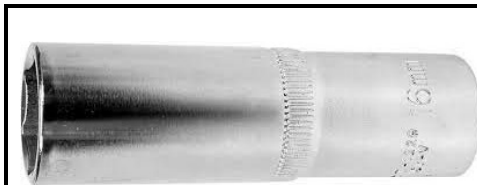
**1/2"**
**Vasos 1/2" Serie Larga**

| Refer:      | mm | Precio € |
|-------------|----|----------|
| 17ZL/11-ELO | 11 | 12,01    |
| 17ZL/12-ELO | 12 | 12,01    |
| 17ZL/14-ELO | 14 | 13,07    |
| 17ZL/15-ELO | 15 | 15,57    |
| 17ZL/16-ELO | 16 | 16,13    |
| 17ZL/18-ELO | 18 | 16,13    |
| 17ZL/21-ELO | 21 | 16,13    |
| 17ZL/27-ELO | 27 | 16,68    |
| 17ZL/32-ELO | 32 | 23,05    |

| Refer:     | mm | Precio € |
|------------|----|----------|
| 18ZL/10-PR | 10 | 4,32     |
| 18ZL/11-PR | 11 | 4,32     |
| 18ZL/12-PR | 12 | 4,32     |
| 18ZL/13-PR | 13 | 4,32     |
| 18ZL/14-PR | 14 | 4,49     |
| 18ZL/15-PR | 15 | 4,49     |
| 18ZL/16-PR | 16 | 4,49     |
| 18ZL/17-PR | 17 | 4,49     |
| 18ZL/18-PR | 18 | 5,31     |
| 18ZL/19-PR | 19 | 5,31     |
| 18ZL/20-PR | 20 | 6,10     |
| 18ZL/21-PR | 21 | 6,10     |
| 18ZL/22-PR | 22 | 6,76     |
| 18ZL/24-PR | 24 | 8,08     |
| 18ZL/27-PR | 27 | 10,30    |
| 18ZL/30-PR | 30 | 12,31    |
| 18ZL/32-PR | 32 | 12,87    |

**Vasos TORX Hembra**

| Refer:       |           | Precio € |
|--------------|-----------|----------|
| 22400/E04-PR | 1/4 x E4  | 2,13     |
| 22400/E05-PR | 1/4 x E5  | 2,13     |
| 22400/E06-PR | 1/4 x E6  | 2,13     |
| 22400/E07-PR | 1/4 x E7  | 2,13     |
| 22400/E08-PR | 1/4 x E8  | 2,13     |
| 22400/E10-PR | 1/4 x E10 | 2,37     |
| 22400/E11-PR | 1/4 x E11 | 2,37     |

| Refer:        |           | Precio € |
|---------------|-----------|----------|
| 770/E3810-TOM | 3/8 x E10 | 2,30     |
| 770/E3812-TOM | 3/8 x E12 | 2,30     |
| 770/E3814-TOM | 3/8 x E14 | 2,30     |
| 770/E3816-TOM | 3/8 x E16 | 2,97     |
| 770/E3818-TOM | 3/8 x E18 | 3,21     |
| 770/E3820-TOM | 3/8 x E20 | 3,45     |

| Refer:     |           | Precio € |
|------------|-----------|----------|
| 201/E10-PR | 1/2 x E10 | 3,39     |
| 201/E11-PR | 1/2 x E11 | 3,39     |
| 201/E12-PR | 1/2 x E12 | 3,39     |
| 201/E14-PR | 1/2 x E14 | 3,39     |
| 201/E16-PR | 1/2 x E16 | 3,48     |
| 201/E18-PR | 1/2 x E18 | 3,72     |
| 201/E20-PR | 1/2 x E20 | 3,72     |
| 201/E22-PR | 1/2 x E22 | 4,05     |
| 201/E24-PR | 1/2 x E24 | 4,50     |



**Vasos de 1/2" de 12 lados**

| Refer:     | mm | Precio € |
|------------|----|----------|
| 17Z/08-ELO | 8  | 4,58     |
| 17Z/09-ELO | 9  | 4,58     |
| 17Z/10-ELO | 10 | 4,58     |
| 17Z/12-ELO | 12 | 4,58     |
| 17Z/21-ELO | 21 | 4,80     |
| 17Z/22-ELO | 22 | 4,80     |
| 17Z/24-ELO | 24 | 5,10     |
| 17Z/27-ELO | 27 | 5,47     |
| 17Z/30-ELO | 30 | 6,90     |
| 17Z/32-ELO | 32 | 6,90     |
| 17Z/36-ELO | 36 | 16,40    |



**Adaptadores Hembra - Hembra**

| Refer:     |                | Precio € |
|------------|----------------|----------|
| 2610/1-ELO | De 3/4" a 1/2" | 16,96    |
| 2610/3-ELO | De 3/4" a 1"   | 19,16    |



**Acoples Ampliadores y Reductores**

| Refer:    | Hembra | Macho | Precio € |
|-----------|--------|-------|----------|
| 20601-PR  | 1/4"   | 3/8"  | 3,71     |
| 20602-PR  | 3/8"   | 1/4"  | 3,71     |
| 20603-PR  | 1/2"   | 3/8"  | 3,71     |
| 20604-PR  | 3/8"   | 1/2"  | 3,71     |
| 20605-PR  | 1/2"   | 3/4"  | 6,92     |
| 20606-PR  | 3/4"   | 1/2"  | 9,06     |
| 780/7-ELO | 1"     | 3/4"  | 28,69    |



**Juego de Reducciones y Ampliaciones, 6 pzs.**

| Refer:   |  | Precio € |
|----------|--|----------|
| 206/6-PR | Macho 1/4 a Hembra 3/8<br>Macho 3/8 a Hembra 1/2<br>Macho 1/2 a Hembra 3/4<br>Macho 3/8 a Hembra 1/4<br>Macho 1/2 a Hembra 3/8<br>Macho 3/4 a Hembra 1/2 | 20,89    |



**Adaptadores Especiales para Puntas de 10 mm, 8 mm y 1/4"**

| Refer:   | Ø    | Puntas de | Precio € |
|----------|------|-----------|----------|
| 20628-PR | 1/2" | 1/4"      | 3,50     |
| 20621-PR | 1/2" | 8 mm      | 3,50     |
| 20620-PR | 1/2" | 10 mm     | 3,50     |
| 20625-PR | 1/2" | 14 mm     | 3,50     |
| 20622-PR | 3/8" | 10 mm     | 3,50     |
| 20623-PR | 3/8" | 8 mm      | 3,50     |



**Acoples Ampliadores y Reductores de Impacto**

| Refer:   | Hembra | Macho | Precio € |
|----------|--------|-------|----------|
| 20609-PR | 1/2"   | 3/4"  | 14,88    |
| 20610-PR | 3/4"   | 1/2"  | 15,62    |
| 20611-PR | 3/4"   | 1"    | 18,02    |
| 20612-PR | 1"     | 3/4"  | 25,22    |



**Vasos 1/2" Impacto**

| Refer:    | Ø mm | Precio € |
|-----------|------|----------|
| 22000/K13 | 13   | 6,15     |
| 22000/K15 | 15   | 6,30     |
| 22000/K17 | 17   | 6,80     |
| 22000/K19 | 19   | 6,80     |
| 22000/K21 | 21   | 7,19     |
| 22000/K22 | 22   | 7,70     |
| 22000/K24 | 24   | 8,18     |

1/2"



**Vasos 1/2" Impacto Largos**

| Refer:    | Ø mm | Precio € |
|-----------|------|----------|
| 22099/K13 | 13   | 9,20     |
| 22099/K15 | 15   | 9,40     |
| 22099/K17 | 17   | 9,67     |
| 22099/K19 | 19   | 9,67     |
| 22099/K21 | 21   | 9,90     |
| 22099/K22 | 22   | 11,50    |
| 22099/K24 | 24   | 13,63    |



**Alargadera 1/2" Impacto**

| Refer:     | Ø    | ↔      | Precio € |
|------------|------|--------|----------|
| 197/125-PR | 1/2" | 125 mm | 11,72    |



1/2"



**Vaso Inyectores "Elora"**
**Refer:**
**775/L1-ELO**

Para Opel Corsa 1.5 L y V.W.

Polo 1.3L cogida de 1/2

Fabricado en C.V. (50CrV4)

**1/2x22x75 y salida de 12 lados.**
**Precio €**
**36,08**

**Vaso BiHexagonal 1/2 para inyectores gasoil**
**Refer:**
**770/LTD27-ELO**
**Medidas**
**27 x 80 mm**
**Precio €**
**23,05**

**Vaso Inyectores "Elora"**
**Refer:**
**775/L3-ELO**

Para motores TDI, Alfa Romeo, Jeep,

Rover, Opel Frontera, Scania y

Mann 6 cilindros D 0226.

Fabricado en CrMo. (42CrMo4)

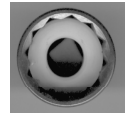
**1/2x28x65 y salida de 12 lados.**
**Precio €**
**53,52**

**Vaso Diferencial y Cigüeñales "Elora"**
**Refer:**
**775/L4-ELO**

Para cigüeñales, cajas de cambio

y diferenciales.

Fabricado en C.V. (50CrV4)

**1/2x30x70 y salida de 12 lados.**
**Precio €**
**49,78**

**Vasos Inyectores "Elora"**
**Refer:**
**776/L1-ELO**

Para motores MB C y clase E Abags

Fabricado en C.V. (50CrV4)

**1/2"x22x110 y salida de 6 lados**
**Precio €**
**43,11**

**Vasos Inyectores "Elora"**
**Refer:**
**776/L2-ELO**

Para motores diesel XUD Citroen y

Peugeot tipo Euro II y Euro III.

Fabricado en CrMo. (42CrMo4)

**1/2x22x150 y salida de 6 lados.**
**Precio €**
**53,45**



**Vasos Inyectores "Elora"**

**Refer:** 776/L3-ELO **Precio €** 56,35

Para motores diesel XUD Citroen y Peugeot tipo Euro II y Euro III.  
Fabricado en CrMo. (42CrMo4)  
1/2x27x110 y salida de 6 lados.



**Vasos Sondas Lambda "Elora"**

**Refer:** 776/L4-ELO **Precio €** 39,88

Para Ford, Nissan, V.W. y Opel.  
Fabricado en CrMo. (42CrMo4)  
1/2x22x70 y salida de 6 lados.



**Vasos Sondas Lambda "Elora"**

**Refer:** 776/L5-ELO **Precio €** 44,74

Para Ford, Nissan, V.W. y Opel.  
Fabricado en CrMo. (42CrMo4)  
1/2x22x110 y salida de 6 lados.



**Vasos Sondas Lambda "Elora"**

**Refer:** 776/L7-ELO **Precio €** 47,86

Para Motores Mann D25 y D28.  
Mann Nr. 80.99603.0255  
Fabricado en CrMo. (42CrMo4)



**Adaptador para vasos de 1/2 con Luz**

**Refer:** 21909-PR **Precio €** 18,54

Hembra 1/2 x Macho 1/2 x 75 mm.

Incluye 3 pilas

**Adaptador Cuadrado Macho**

| Refer:    |     |       | Precio € |
|-----------|-----|-------|----------|
| 1202VK-PR | 1/2 | 38 mm | 3,60     |

**Alargaderas de Carraca Flexibles**

| Refer:      |      |        | Precio € |
|-------------|------|--------|----------|
| 3008557-TOP | 1/4" | 140 mm | 6,16     |
| 21918-PR    | 1/2" | 210 mm | 26,22    |

**Alargaderas de Carraca**

| Refer:      |      |     | Precio € |
|-------------|------|-----|----------|
| 203/50-PR   | 1/4" | 50  | 1,26     |
| 203/14-PR   | 1/4" | 75  | 1,50     |
| 203/100-PR  | 1/4" | 100 | 1,80     |
| 205/75-PR   | 3/8" | 75  | 3,12     |
| 205/150P-PR | 3/8" | 150 | 4,58     |
| 203/65-PR   | 1/2" | 75  | 3,65     |
| 203-PR      | 1/2" | 125 | 4,47     |
| 204-PR      | 1/2" | 250 | 9,90     |
| 770/S3-PR   | 3/4" | 100 | 17,22    |
| 770/S4-ELO  | 3/4" | 200 | 20,15    |
| 770/S5-ELO  | 3/4" | 400 | 39,79    |

**Manerales de Carraca**

| Refer:       |      |     | Precio € |
|--------------|------|-----|----------|
| 202/14-PR    | 1/4" | 115 | 3,97     |
| 202/250-PR   | 1/2" | 250 | 11,13    |
| 770/34450-PR | 3/4" | 450 | 32,56    |



**Articulaciones Cardan**

| Refer:    |      |    | Precio € |
|-----------|------|----|----------|
| 205/14-PR | 1/4" | 38 | 3,57     |
| 205/12-PR | 1/2" | 72 | 8,26     |



Calidad: Cromo Vanadio

**Llaves Torx Planas de doble boca**

| Refer:    |  | Precio € |
|-----------|---|----------|
| 1001/1-PR | E 6 x E 8   | 6,09     |
| 1001/2-PR | E10 x E12   | 6,76     |
| 1001/3-PR | E14 x E18   | 7,83     |
| 1001/4-PR | E20 x E24   | 12,41    |





**Llaves Articuladas doble boca cerrada con 12 lados**

En Cromo Vanadio 31 CrV3

| Refer:         |  mm | Precio € | Refer:         |  mm | Precio € |
|----------------|--|----------|----------------|--|----------|
| 83825/1415-PAD | 14 x 15  | 12,50    | 83825/2022-PAD | 20 x 22  | 21,00    |
| 83825/1617-PAD | 16 x 17  | 13,50    | 83825/2123-PAD | 21 x 23  | 22,50    |
| 83825/1819-PAD | 18 x 19  | 16,30    |                |  |          |



Para vasos y puntas de atornillador de 1/4"

**Llave Articulada de 1/4 Macho x 1/4 Hembra**

| Refer:  | Precio € |
|---------|----------|
| 4440-PR | 11,98    |



**Llaves Planas abiertas de doble boca para racores "Elora" Din 3118**

| Refer:       |  mm | Precio € |
|--------------|--|----------|
| 121/1618-ELO | 16 x 18  | 19,30    |

**Llaves Planas Fijas**
**Din 3110**

| Refer:     | mm            | Precio € |
|------------|---------------|----------|
| 2/0607-TOM | 6 x 7 x 130   | 1,72     |
| 2/0809-TOM | 8 x 9 x 140   | 1,88     |
| 2/1011-TOM | 10 x 11 x 156 | 2,11     |
| 2/1213-TOM | 12 x 13 x 172 | 2,57     |
| 2/1415-TOM | 14 x 15 x 190 | 3,28     |
| 2/1617-TOM | 16 x 17 x 202 | 3,83     |
| 2/1819-TOM | 18 x 19 x 220 | 4,51     |

| Refer:     | mm            | Precio € |
|------------|---------------|----------|
| 2/2022-TOM | 20 x 22 x 235 | 6,47     |
| 2/2123-TOM | 21 x 23 x 250 | 7,59     |
| 2/2427-TOM | 24 x 27 x 263 | 9,37     |
| 2/2528-TOM | 25 x 28 x 278 | 10,69    |
| 2/3032-TOM | 30 x 32 x 290 | 13,86    |
| 2/3641-TOM | 36 x 41 x 360 | 24,85    |
| 2/5560-TOM | 55 x 60 x 560 | 98,50    |

**Llaves de Tubo Huecas**
**Din 896 Forma B**

| Refer:       | mm            | Precio € |
|--------------|---------------|----------|
| 210/0607-TOM | 6 x 7 x 105   | 2,53     |
| 210/0809-TOM | 8 x 9 x 105   | 2,71     |
| 210/1011-TOM | 10 x 11 x 120 | 2,88     |
| 210/1213-TOM | 12 x 13 x 140 | 3,22     |
| 210/1415-TOM | 14 x 15 x 140 | 3,41     |
| 210/1617-TOM | 16 x 17 x 150 | 4,27     |
| 210/1819-TOM | 18 x 19 x 160 | 5,31     |

| Refer:       | mm            | Precio € |
|--------------|---------------|----------|
| 210/2022-TOM | 20 x 22 x 170 | 5,39     |
| 210/2123-TOM | 21 x 23 x 170 | 5,48     |
| 210/2427-TOM | 24 x 27 x 190 | 8,14     |
| 210/2528-TOM | 25 x 28 x 200 | 8,91     |
| 210/3032-TOM | 30 x 32 x 200 | 9,62     |
| 210/3641-TOM | 36 x 41 x 200 | 10,56    |

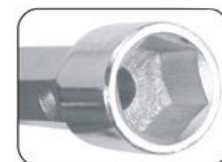
**Llaves de Tubo Macizas**
**Din 896 Forma A**

| Refer:       | mm            | Precio € |
|--------------|---------------|----------|
| 211/0607-TOM | 6 x 7 x 105   | 3,95     |
| 211/0809-TOM | 8 x 9 x 110   | 4,32     |
| 211/1011-TOM | 10 x 11 x 130 | 4,59     |
| 211/1213-TOM | 12 x 13 x 140 | 5,14     |

| Refer:       | mm            | Precio € |
|--------------|---------------|----------|
| 211/1415-TOM | 14 x 15 x 150 | 5,30     |
| 211/1617-TOM | 16 x 17 x 160 | 6,32     |
| 211/1819-TOM | 18 x 19 x 165 | 8,03     |

**Llaves de Pipa abiertas acodadas**
**Din 691**

| Refer:     | mm       | Precio € |
|------------|----------|----------|
| 212/08-TOM | 8 x 115  | 4,07     |
| 212/10-TOM | 10 x 130 | 4,51     |
| 212/13-TOM | 13 x 152 | 5,39     |

| Refer:     | mm       | Precio € |
|------------|----------|----------|
| 212/17-TOM | 17 x 187 | 7,15     |
| 212/19-TOM | 19 x 205 | 7,75     |

**Llaves Mixtas Combinadas**
**Din 3113 For A**

| Refer:   | mm       | Precio € |
|----------|----------|----------|
| 3/06-TOM | 6 x 103  | 2,23     |
| 3/07-TOM | 7 x 103  | 2,23     |
| 3/08-TOM | 8 x 113  | 2,32     |
| 3/09-TOM | 9 x 123  | 2,75     |
| 3/10-TOM | 10 x 133 | 3,07     |
| 3/11-TOM | 11 x 143 | 4,44     |
| 3/12-TOM | 12 x 153 | 4,60     |
| 3/13-TOM | 13 x 153 | 4,60     |
| 3/14-TOM | 14 x 172 | 4,78     |
| 3/15-TOM | 15 x 172 | 4,78     |
| 3/16-TOM | 16 x 197 | 4,96     |
| 3/17-TOM | 17 x 197 | 5,12     |
| 3/18-TOM | 18 x 218 | 5,40     |
| 3/19-TOM | 19 x 218 | 5,40     |
| 3/20-TOM | 20 x 232 | 7,50     |

| Refer:   | mm       | Precio € |
|----------|----------|----------|
| 3/21-TOM | 21 x 232 | 7,50     |
| 3/22-TOM | 22 x 246 | 7,68     |
| 3/23-TOM | 23 x 265 | 11,31    |
| 3/24-TOM | 24 x 265 | 12,90    |
| 3/25-TOM | 25 x 290 | 14,02    |
| 3/26-TOM | 26 x 290 | 15,68    |
| 3/27-TOM | 27 x 315 | 15,75    |
| 3/28-TOM | 28 x 315 | 19,70    |
| 3/29-TOM | 29 x 320 | 20,95    |
| 3/30-TOM | 30 x 340 | 21,70    |
| 3/32-TOM | 32 x 365 | 23,40    |
| 3/34-TOM | 34 x 390 | 35,12    |
| 3/36-TOM | 36 x 460 | 52,16    |
| 3/50-TOM | 50 x 560 | 92,00    |

**Llaves Acodadas de doble boca**
**Din 838**

| Refer:     | mm            | Precio € |
|------------|---------------|----------|
| 5/0607-TOM | 6 x 7 x 130   | 3,57     |
| 5/0809-TOM | 8 x 9 x 145   | 3,95     |
| 5/1011-TOM | 10 x 11 x 160 | 4,59     |
| 5/1213-TOM | 12 x 13 x 175 | 5,24     |
| 5/1415-TOM | 14 x 15 x 190 | 6,60     |
| 5/1617-TOM | 16 x 17 x 202 | 8,15     |
| 5/1819-TOM | 18 x 19 x 220 | 8,92     |

| Refer:     | mm            | Precio € |
|------------|---------------|----------|
| 5/2022-TOM | 20 x 22 x 230 | 12,15    |
| 5/2123-TOM | 21 x 23 x 250 | 14,30    |
| 5/2427-TOM | 24 x 27 x 265 | 16,56    |
| 5/2528-TOM | 25 x 28 x 278 | 17,30    |
| 5/3032-TOM | 30 x 32 x 380 | 19,75    |
| 5/3842-TOM | 38 x 42 x 455 | 49,25    |
| 5/3641-TOM | 46 x 50 x 455 | 76,50    |

**Llaves Mixtas de Carraca**

| Refer:      | mm | Precio € |
|-------------|----|----------|
| 4100/07-TOM | 7  | 4,25     |
| 4100/08-TOM | 8  | 4,55     |
| 4100/09-TOM | 9  | 4,75     |
| 4100/10-TOM | 10 | 4,90     |
| 4100/11-TOM | 11 | 5,80     |
| 4100/12-TOM | 12 | 6,45     |
| 4100/13-TOM | 13 | 6,80     |
| 4100/14-TOM | 14 | 6,90     |
| 4100/15-TOM | 15 | 7,60     |
| 4100/16-TOM | 16 | 8,05     |
| 4100/17-TOM | 17 | 8,85     |

| Refer:      | mm | Precio € |
|-------------|----|----------|
| 4100/18-TOM | 18 | 9,80     |
| 4100/19-TOM | 19 | 10,50    |
| 4100/20-TOM | 20 | 15,33    |
| 4100/21-TOM | 21 | 16,92    |
| 4100/22-TOM | 22 | 17,64    |
| 4100/23-PR  | 23 | 19,08    |
| 4100/24-TOM | 24 | 20,61    |
| 4100/25-TOM | 25 | 24,09    |
| 4100/27-TOM | 27 | 26,43    |
| 4100/30-PR  | 30 | 30,90    |
| 4100/32-PR  | 32 | 41,80    |

**Llaves Mixtas de Carraca Articuladas**

| Refer:      | mm | Precio € |
|-------------|----|----------|
| 4106/08-PR  | 8  | 11,68    |
| 4106/09-PR  | 9  | 12,19    |
| 4106/10-TOM | 10 | 12,25    |
| 4106/11-PR  | 11 | 12,63    |
| 4106/12-PR  | 12 | 12,72    |
| 4106/13-PR  | 13 | 14,71    |
| 4106/14-PR  | 14 | 15,81    |
| 4106/15-PR  | 15 | 17,19    |
| 4106/16-PR  | 16 | 19,30    |

| Refer:      | mm | Precio € |
|-------------|----|----------|
| 4106/17-TOM | 17 | 20,47    |
| 4106/18-PR  | 18 | 21,93    |
| 4106/19-PR  | 19 | 23,08    |
| 4106/20-PR  | 20 | 23,27    |
| 4106/21-PR  | 21 | 24,28    |
| 4106/22-PR  | 22 | 24,78    |
| 4106/23-PR  | 23 | 25,30    |
| 4106/24-PR  | 24 | 26,55    |
| 4106/26-PR  | 26 | 29,00    |

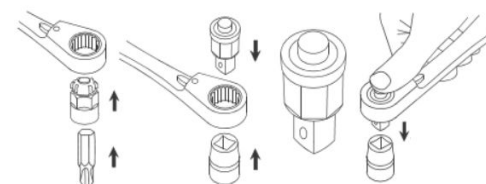
**Juego de Adaptadores para Llaves Mixtas de Carraca**
**Refer:**  
**4090-PR**
**Precio €**  
 15,13

 10 mm para vasos de 1/4"  
 13 mm para vasos de 3/8"  
 19 mm para vasos de 1/2"  
 10 mm para puntas de 1/4"

**Juegos de LLaves Planas**

|                   |          |                 |
|-------------------|----------|-----------------|
| <b>Refer:</b>     |          | <b>Precio €</b> |
| <b>25/08T-TOM</b> | 8 piezas | 15,80           |

Nros: 6x7, 8x9, 10x11, 12x13, 14x15, 16x17, 18x19 y 20x22

|                   |           |                 |
|-------------------|-----------|-----------------|
| <b>Refer:</b>     |           | <b>Precio €</b> |
| <b>25/12T-TOM</b> | 12 piezas | 41,17           |

Nros: 6x7, 8x9, 10x11, 12x13, 14x15, 16x17, 18x19, 20x22, 21x23, 24x27, 25x28 y 30x32

**Juegos de LLaves Acodadas**

|                   |          |                 |
|-------------------|----------|-----------------|
| <b>Refer:</b>     |          | <b>Precio €</b> |
| <b>10/08T-TOM</b> | 8 piezas | 23,38           |

Nros: 6x7, 8x9, 10x11, 12x13, 14x15, 16x17, 18x19 y 20x22

|                   |           |                 |
|-------------------|-----------|-----------------|
| <b>Refer:</b>     |           | <b>Precio €</b> |
| <b>10/12T-TOM</b> | 12 piezas | 45,57           |

Nros: 6x7, 8x9, 10x11, 12x13, 14x15, 16x17, 18x19, 20x22, 21x23, 24x27, 25x28 y 30x32

**Juegos de LLaves Mixtas**

|                   |          |                 |
|-------------------|----------|-----------------|
| <b>Refer:</b>     |          | <b>Precio €</b> |
| <b>35/08T-TOM</b> | 8 piezas | 11,26           |

Nros: 6, 8, 10, 11, 13, 14, 17 y 19

|                   |           |                 |
|-------------------|-----------|-----------------|
| <b>Refer:</b>     |           | <b>Precio €</b> |
| <b>35/12T-TOM</b> | 12 piezas | 18,90           |

Nros: 6, 7, 8, 9, 10, 11, 12, 13, 14, 17, 19 y 22

**Juego Llaves Tubo Huecas**

|               |          |                 |
|---------------|----------|-----------------|
| <b>Refer:</b> |          | <b>Precio €</b> |
| <b>125-PR</b> | 9 piezas | 19,55           |

Nros: 6x7, 8x9, 10x11, 12x13, 14x15, 16x17, 18x19 y 20x22

1 Barra de apriete





**Juego Llaves Tubo Macizas**

|                |          |                 |
|----------------|----------|-----------------|
| <b>Refer:</b>  |          | <b>Precio €</b> |
| <b>211-TOM</b> | 7 piezas | 29,75           |

Nros: 6x7, 8x9, 10x11, 12x13,  
14x15 y 16x17

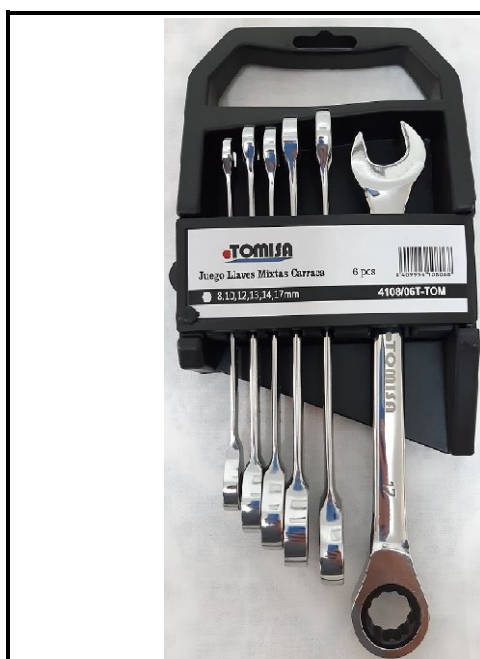
1 Barra de apriete

**Juego Llaves Mixtas de Carraca**

|                     |          |                 |
|---------------------|----------|-----------------|
| <b>Refer:</b>       |          | <b>Precio €</b> |
| <b>4108/06T-TOM</b> | 6 piezas | 34,21           |

Nros: 8, 10, 12, 13, 14 y 17

Sobre soporte de plástico con asa

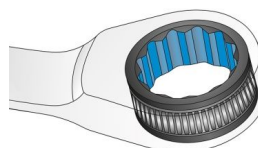



**Conteras Redondas Exteriores (100 uds)**

| Refer:    | Medida | Color | Precio € |
|-----------|--------|-------|----------|
| NS/06N-MK | 6 mm   | N     | 3,75     |
| NS/08N-MK | 8 mm   | B / N | 4,22     |
| NS/10N-MK | 10 mm  | B / N | 4,90     |
| NS/12N-MK | 12 mm  | B / N | 5,08     |
| NS/14N-MK | 14 mm  | B / N | 5,74     |
| NS/16N-MK | 16 mm  | B / N | 6,22     |
| NS/18N-MK | 18 mm  | B / N | 6,89     |
| NS/20N-MK | 20 mm  | B / N | 7,77     |
| NS/22N-MK | 22 mm  | B / N | 8,86     |
| NS/25N-MK | 25 mm  | B / N | 9,54     |
| NS/28N-MK | 28 mm  | B / N | 12,22    |
| NS/30N-MK | 30 mm  | B / N | 17,72    |
| NS/32N-MK | 32 mm  | B / N | 19,54    |
| NS/35N-MK | 35 mm  | B / N | 21,97    |
| NS/40N-MK | 40 mm  | B / N | 28,19    |
| NS/45N-MK | 45 mm  | B / N | 51,49    |
| NS/50N-MK | 50 mm  | B / N | 61,87    |
| NS/60N-MK | 60 mm  | N     | 86,98    |



**Conteras Redondas Interiores (100 uds)**

| Refer:        | Medida | Color        | Precio € |
|---------------|--------|--------------|----------|
| STRIP/12N-MK  | 12 mm  | N            | 5,32     |
| STRIP/14N-MK  | 14 mm  | N            | 6,22     |
| STRIP/16N-MK  | 16 mm  | B / N        | 6,43     |
| STRIP/18N-MK  | 18 mm  | B / N        | 7,09     |
| STRIP/20N-MK  | 20 mm  | B / N        | 7,48     |
| STRIP/22N-MK  | 22 mm  | B / N        | 8,19     |
| STRIP/25N-MK  | 25 mm  | B / N        | 9,38     |
| STRIP/28N-MK  | 28 mm  | B / N        | 10,47    |
| STRIP/30N-MK  | 30 mm  | B / N        | 11,83    |
| STRIP/32N-MK  | 32 mm  | B / N        | 14,57    |
| STRIP/35N-MK  | 35 mm  | B / N        | 18,38    |
| STRIP/38N-MK  | 38 mm  | B / N        | 21,97    |
| STRIP/40N-MK  | 40 mm  | B / N        | 25,30    |
| STRIP/45N-MK  | 45 mm  | B / N        | 28,72    |
| STRIP/50N-MK  | 50 mm  | B / N        | 32,34    |
| STRIP/60N-MK  | 60 mm  | B / N        | 35,60    |
| STRIP/70N-MK  | 70 mm  | N 50 uds     | 47,62    |
| STRIP/80N-MK  | 80 mm  | B / N 50 uds | 44,17    |
| STRIP/90N-MK  | 90 mm  | N 50 uds     | 81,21    |
| STRIP/100N-MK | 100 mm | B / N 25 uds | 65,62    |
| STRIP/120N-MK | 120 mm | N 25 uds     | 70,89    |

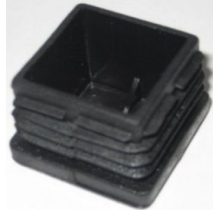

**Conteras Cuadradas Interiores (100 uds)**

| Refer:        | Medida | Color        | Precio € |
|---------------|--------|--------------|----------|
| STRK/10N-MK   | 10 mm  | N            | 5,48     |
| STRK/12N-MK   | 12 mm  | N            | 5,80     |
| STRK/14N-MK   | 14 mm  | B / N        | 6,11     |
| STRK/16N-MK   | 16 mm  | B / N        | 7,22     |
| KEXT/16N-MK   | 16 mm  | N exterior   | 13,72    |
| STRK/18N-MK   | 18 mm  | B / N        | 7,64     |
| STRK/20N-MK   | 20 mm  | B / N        | 8,03     |
| KEXT/20N-MK   | 20 mm  | N exterior   | 15,36    |
| STRK/22N-MK   | 22 mm  | B / N        | 9,57     |
| STRK/25N-MK   | 25 mm  | B / N        | 9,99     |
| KEXT/25N-MK   | 25 mm  | N exterior   | 16,42    |
| STRK/30N-MK   | 30 mm  | B / N        | 13,80    |
| KEXT/30N-MK   | 30 mm  | N exterior   | 17,54    |
| STRK/35N-MK   | 35 mm  | B / N        | 15,03    |
| STRK/40N-MK   | 40 mm  | B / N        | 21,58    |
| STRK/45N-MK   | 45 mm  | B / N        | 31,44    |
| STRK/50N-MK   | 50 mm  | B / N        | 26,20    |
| STRK/60N-MK   | 60 mm  | B / N        | 28,38    |
| STRK/70N-MK   | 70 mm  | B / N 50 uds | 100,45   |
| STRK/80NC-MK  | 80 mm  | B / N 50 uds | 55,18    |
| STRK/90N-MK   | 90 mm  | N 50 uds     | 106,96   |
| STRK/100NA-MK | 100 mm | B / N 25 uds | 62,99    |
| STRK/120NA-MK | 120 mm | N 20 uds     | 61,80    |

**Conteras Rectangulares Interiores (100 uds)**

| Refer:         | Medida     | Color | Precio € |
|----------------|------------|-------|----------|
| STRKK/2010N-MK | 20 x 10 mm | N     | 7,13     |
| STRKK/2015N-MK | 20 x 15 mm | N     | 7,86     |
| STRKK/2510N-MK | 25 x 10 mm | N     | 9,42     |
| STRKK/2515N-MK | 25 x 15 mm | N     | 8,50     |
| STRKK/3010N-MK | 30 x 10 mm | N     | 8,86     |
| STRKK/3015N-MK | 30 x 15 mm | B / N | 9,57     |
| STRKK/3020N-MK | 30 x 20 mm | B / N | 10,05    |
| STRKK/3025N-MK | 30 x 25 mm | N     | 11,82    |
| STRKK/3515N-MK | 35 x 15 mm | N     | 10,93    |
| STRKK/3520N-MK | 35 x 20 mm | B / N | 12,01    |
| STRKK/3525N-MK | 35 x 25 mm | N     | 17,45    |
| STRKK/4010N-MK | 40 x 10 mm | B / N | 11,44    |
| STRKK/4015N-MK | 40 x 15 mm | N     | 11,50    |
| STRKK/4020N-MK | 40 x 20 mm | B / N | 15,72    |
| STRKK/4025N-MK | 40 x 25 mm | N     | 16,39    |
| STRKK/4030N-MK | 40 x 30 mm | B / N | 17,48    |

|                 |             |              |       |
|-----------------|-------------|--------------|-------|
| STRKK/5010N-MK  | 50 x 10 mm  | N            | 23,63 |
| STRKK/5015N-MK  | 50 x 15 mm  | N            | 15,57 |
| STRKK/5020N-MK  | 50 x 20 mm  | B / N        | 17,35 |
| STRKK/5025N-MK  | 50 x 25 mm  | N            | 19,15 |
| STRKK/5030N-MK  | 50 x 30 mm  | N            | 21,99 |
| STRKK/5040N-MK  | 50 x 40 mm  | N            | 39,04 |
| STRKK/6010N-MK  | 60 x 10 mm  | N            | 18,53 |
| STRKK/6020N-MK  | 60 x 20 mm  | B / N        | 27,70 |
| STRKK/6030N-MK  | 60 x 30 mm  | B / N        | 21,66 |
| STRKK/6040N-MK  | 60 x 40 mm  | B / N        | 30,44 |
| STRKK/7020B-MK  | 70 x 20 mm  | B / N 50 uds | 19,02 |
| STRKK/7030N-MK  | 70 x 30 mm  | N 50 uds     | 19,46 |
| STRKK/7040N-MK  | 70 x 40 mm  | B / N 50 uds | 25,22 |
| STRKK/7050N-MK  | 70 x 50 mm  | N            | 54,93 |
| STRKK/8020N-MK  | 80 x 20 mm  | B / N        | 36,99 |
| STRKK/8030N-MK  | 80 x 30 mm  | N 50 uds     | 19,62 |
| STRKK/8040N-MK  | 80 x 40 mm  | B / N        | 27,27 |
| STRKK/8060N-MK  | 80 x 60 mm  | N 50 uds     | 31,34 |
| STRKK/10020N-MK | 100 x 20 mm | N 25 uds     | 17,05 |
| STRKK/10030N-MK | 100 x 30 mm | N 50 uds     | 41,88 |
| STRKK/10040N-MK | 100 x 40 mm | B / N 50 uds | 60,20 |
| STRKK/10050N-MK | 100 x 50 mm | B / N 50 uds | 67,19 |
| STRKK/10060N-MK | 100 x 60 mm | N 50 uds     | 57,44 |
| STRKK/12040N-MK | 120 x 40 mm | N 25 uds     | 70,76 |
| STRKK/12060N-MK | 120 x 60 mm | N 25 uds     | 73,45 |

**Topes de puerta Atornillables (100 uds)**

| Refer:    | Ø     | Color  | Precio € |
|-----------|-------|--------|----------|
| TP/1BB-MK | 26 mm | Blanco | 13,49    |

**Soportes y Casquillos para baldas (100 uds)**

| Refer:      | Medida | Modelo           | Precio € |
|-------------|--------|------------------|----------|
| MS/1N-MK    | 8 mm   | Soporte Negro    | 4,43     |
| MS2/ANGN-MK | 6 mm   | Soporte Marrón   | 2,19     |
| MS2/ANGB-MK | 6 mm   | Soporte Blanco   | 2,19     |
| MS2/CASN-MK | 6-8mm  | Casquillo Marrón | 2,48     |
| MS2/CASB-MK | 6-8mm  | Casquillo Blanco | 2,48     |

**Tapón para Tornillos Pz-2 (1000 uds)**

| Refer:    | Ø     | Color | Precio € |
|-----------|-------|-------|----------|
| 8913N-TOM | 13 mm | Negro | 16,80    |
| 8913R-TOM | 13 mm | Roble | 16,80    |

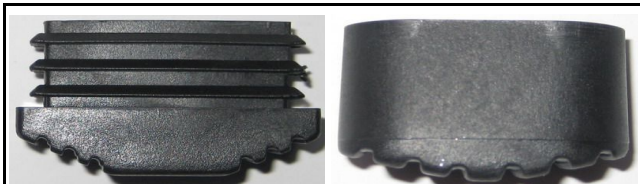

**Tapón para Tornillos 4,8 mm (500 uds)**

| Refer: | Ø       | Color  | Precio € |
|--------|---------|--------|----------|
| 94TN   | 11,5 mm | Negro  | 19,56    |
| 91TB   | 11,5 mm | Blanco | 19,56    |

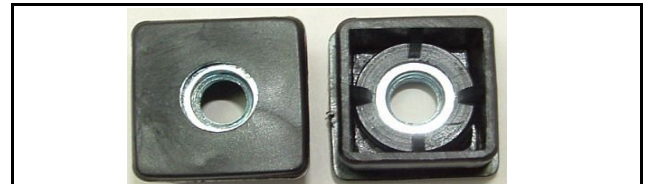

**Conteras para Escaleras (100 uds)**

| Refer:    | Medida     | Modelo   | Precio € |
|-----------|------------|----------|----------|
| E418/N-MK | 40 x 20 mm | Exterior | 19,53    |
| E455/N-MK | 50 x 20 mm | Interior | 29,26    |



**Tacos Cuadrados Interiores (25 uds)**

| Refer:       | Medida | Métrica | Precio € |
|--------------|--------|---------|----------|
| E474/M10N-MK | 30 mm  | M-10    | 13,56    |
| E474/35N-MK  | 35 mm  | M-10    | 13,92    |
| E457/M10N-MK | 40 mm  | M-10    | 14,79    |
| E457/50N-MK  | 50 mm  | M-10    | 27,17    |



**Cantoneras en Angulo (100 uds)**

| Refer:    | Medida | Modelo   | Precio € |
|-----------|--------|----------|----------|
| E360/N-MK | 35 mm  | Exterior | 9,30     |
| E417/N-MK | 40 mm  | Exterior | 11,77    |



**Conteras Ovaladas Interiores (100 uds)**

| Refer:         | Pared    | Medida     | Precio € |
|----------------|----------|------------|----------|
| STRFLEX/30N-MK | Estriada | 30 x 15 mm | 16,00    |
| FLEX/3515N-MK  | Lisa     | 35 x 15 mm | 16,00    |

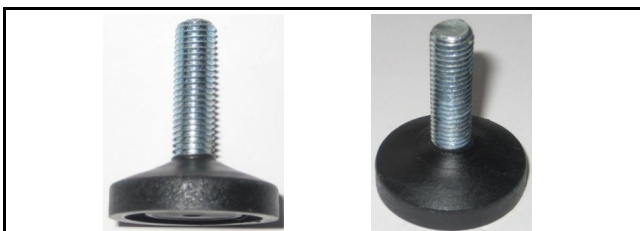

**Patas Niveladoras (25 uds)**

| Refer:        | Base  | Tornillo     | Precio € |
|---------------|-------|--------------|----------|
| PR30/M840N-MK | 30 mm | M-8 x 30 mm  | 17,41    |
| PR30/M104N-MK | 30 mm | M-10 x 30 mm | 17,41    |
| PR42/M104N-MK | 42 mm | M-10 x 30 mm | 17,41    |
| E148/M10N-MK  | 52 mm | M-10 x 30 mm | 21,40    |
| E148/M12N-MK  | 52 mm | M-12 x 30 mm | 21,81    |



**Pomos Reguladores (25 uds)**

| Refer:     | Base  | Tornillo     | Precio € |
|------------|-------|--------------|----------|
| PM/6N-MK   | 30 mm | M-6 x 20 mm  | 13,12    |
| PM/8N-MK   | 30 mm | M-8 x 20 mm  | 14,36    |
| PMG/8N-MK  | 30 mm | M-8 x 25 mm  | 17,13    |
| PM/10N-MK  | 30 mm | M-10 x 25 mm | 17,98    |
| PMG/10N-MK | 40 mm | M-10 x 30 mm | 18,90    |



**Tapatuercas de Plástico (100 uds)**

| Refer:     | Medida | Color  | Precio € |
|------------|--------|--------|----------|
| E407/AB-MK | M-6    | Blanco | 9,65     |
| E407/AN-MK | M-6    | Negro  | 9,65     |
| E471/B-MK  | M-8    | Blanco | 10,58    |
| E471/N-MK  | M-8    | Negro  | 10,58    |
| E433/B-MK  | M-10   | Blanco | 14,81    |
| E433/N-MK  | M-10   | Negro  | 14,81    |
| E434/B-MK  | M-12   | Blanco | 23,25    |
| E434/N-MK  | M-12   | Negro  | 23,25    |
| E436/B-MK  | M-16   | Blanco | 25,26    |
| E436/N-MK  | M-16   | Negro  | 25,26    |



**Topes Cilíndricos de Plástico (100 uds)**

| Refer:    | Medida | Precio € |
|-----------|--------|----------|
| WC/00B-MK | 12 mm  | 5,18     |
| WC/0B-MK  | 19 mm  | 5,33     |
| WC/1B-MK  | 23 mm  | 5,49     |



**Conteras Goma Andador Alta (50 uds)**

| Refer:     | Medida | Color | Precio € |
|------------|--------|-------|----------|
| 88413/N-CC | 25 mm  | Negro | 24,66    |
| 88413/G-CC | 25 mm  | Gris  | 36,88    |



**Conteras Goma Muleta Alta (50 uds)**

| Refer:   | Medida | Color | Precio € |
|----------|--------|-------|----------|
| 88417-CC | 17 mm  | Negro | 46,61    |
| 88419-CC | 19 mm  | Negro | 46,61    |
| 88421-CC | 21 mm  | Negro | 46,61    |



**Conteras Goma Redonda (50 uds)**

| Refer:      | Medida | Color | Precio € |
|-------------|--------|-------|----------|
| 88411/10-CC | 10 mm  | Negro | 10,31    |
| 88411/12-CC | 12 mm  | Negro | 10,39    |
| 88411/14-CC | 14 mm  | Negro | 11,46    |
| 88411/16-CC | 16 mm  | Negro | 14,06    |
| 88411/18-CC | 18 mm  | Negro | 14,72    |
| 88411/20-CC | 20 mm  | Negro | 15,47    |
| 88411/22-CC | 22 mm  | Negro | 15,91    |
| 88411/25-CC | 25 mm  | Negro | 18,02    |
| 88411/28-CC | 28 mm  | Negro | 23,83    |
| 88411/30-CC | 30 mm  | Negro | 20,35    |
| 88411/35-CC | 35 mm  | Negro | 24,00    |
| 88411/38-CC | 38 mm  | Negro | 31,24    |

## **CONDICIONES GENERALES DE VENTA**

---

### **Objeto y Vigencia**

Las condiciones generales de venta y prestación de servicios regula las transacciones comerciales entre Tomisa Herramientas, S.L. y el cliente, donde la primera vende y la segunda compra materiales comercializados por Tomisa.

Las presentes condiciones generales entran en vigor el día de apertura de ficha del cliente, y prevalece sobre cualquier condición general del cliente, salvo acuerdo escrito.

### **Precio**

Los precios de las mercancías adquiridas por el cliente son los que se encuentran en vigor el día del pedido, denominados en Euros, a los que añadir el impuesto legal en vigor y gastos de transporte aplicables en el momento de la formalización del pedido.

Los precios que aparecen en la tarifa Tomisa están sujetos a alteraciones por circunstancias del mercado sin previo aviso.

### **Forma de Pago**

Los pagos podrán ser realizados por el cliente mediante transferencia bancaria contra factura proforma con descuento financiero del 2%.

Después del primer pedido, los pagos podrán ser realizados mediante giro domiciliado a 30 o 60 días fecha factura, en función del valor de la mercancía.

### **Transporte y Entregas**

Los pedidos serán despachados por cuenta de nuestra agencia de transporte, salvo en los casos que el cliente envíe a su propia agencia a relizar la recogida, corriendo en este caso a su cuenta.

Los pedidos superiores a 150 € serán entregados a portes pagados.

Para pedidos inferiores a 150 €, se cargarán 5 € en concepto de portes en factura.

### **Reclamaciones y Devoluciones**

El cliente tiene derecho a devolución previa reclamación por escrito, debidamente fundamentada y acompañada de copia de factura. No se admitirán reclamaciones ni devoluciones pasados 15 días.